

REMS

www.rems.de



Innovative
manufacturer of
machines and tools
for pipe working

2016

Catalogue

















REMS
for Professionals

REMS
FOR PROFESSIONALS

REMS
FOR PROFESSIONALS

Contents

	Threading Roll Grooving	20
	Sawing	52
	Cutting, Chamfering, Deburring	66
	Assembling	88
	Testing, cleaning, disinfecting, preserving, flushing, filling	96
	Bending	106
	Radial Press Jointing	118
	Axial Press Jointing	164
	Expanding, Extracting	174
	Soldering	188
	Freezing	194
	Pipe and Drain Inspection / Pipe and Drain Cleaning	198
	Plastic Pipe Welding	212
	Diamond Core Drilling Diamond chasing saws	222

We deliver exclusively on the basis of our general conditions of sale and delivery.

The prices stated in this catalogue are valid for one piece respectively for one set (e.g. dies) or one pack (e.g. saw blades). Prices do not include any value added tax (VAT) and are subject to change without notice. These prices supersede all previous prices.

Drawings, illustrations, dimensions, weights, standards and other data stated in this catalogue are not binding and are subject to alteration. All power data stated to be understood as the rated power input. Subject to alternation. All rights reserved, particularly for translations, reproductions, illustrations, radio transmission, photomechanic reproductions or similar and storage of data in computers, including utilization in extracts.

© Copyright 2016
REMS GmbH & Co KG, Waiblingen.

Sale through specialist dealers.



They are creative and have plenty of practical experience, they continuously find possibilities for improvement of the work of the installation professional: REMS development engineers are innovative and therefore important factors in the success of the company.

REMS – heading technical progress for more than 100 years. Development is never finished.

Since its foundation in 1909 REMS has been developing products for the pipe working, especially for sanitary and heating installers. At first, hand tools and then subsequently machines and electric power tools. The stipulation of the company founder Christian Föll "REMS must be superior" has always been the benchmark for our actions. Today REMS is a leading manufacturer of machines and tools for the pipe working.

REMS development engineers have persuasive, groundbreaking ideas which ease the daily routines of the installations professional. They have all the significant requirements in their focus and use all their comprehensive practical experience. Experts from all areas of industry ensure that every possibility for improvement is integrated in the new development. In this way the perfect tools for the tough demands of the building site are created. The REMS products are highly valued because of their innovative technology as well as their high standards of quality and are being used everywhere in the world. Both trade and user profit in this way.

Again and again REMS is able to maintain its position at the forefront of technical progress as a result of its innovative products. Many valid national and international patents prove this.

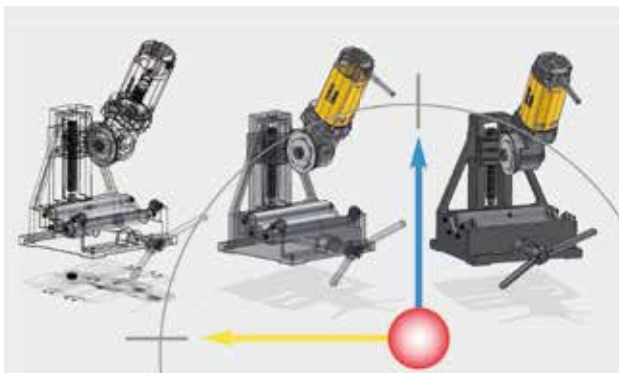

Through the application of modern construction and development techniques, the quality of REMS products has been to the fore from the beginning: Safe use, robust design, simple operation, durability.



New ideas, technical progress and REMS belong together: e.g. REMS Amigo, REMS Tiger, REMS Curvo, REMS Mini-Press ACC – products, which have revolutionised the application technology.



Fully automatic 3D measuring machines are a part of the comprehensive quality control system at REMS. The accuracy of measurements at 0.001 mm guarantees the highest precision.

Highly modern production – guarantor for REMS quality products.

Made in Germany. Our own production plant is located in Waiblingen near Stuttgart, in the centre of Germany's high-tech industrial region. There highly modern equipment and facilities are available for research and development, for production and quality control. In addition to this there is a permanent staff of highly-qualified employees, who in part represent the 4th generation of service at REMS. They have the special level of knowledge and experience that is essential for the manufacture of quality products.

Quality means much more to REMS than simply dimensional accuracy and function. It is backed up by a comprehensive quality control system, which begins as early as the assessment of market needs and which is ever present during the product development and manufacture and continues with systematic quality analysis in the market. Furthermore the quality of the production processes is regularly monitored and affirmed by the testing agency that awards the GS safety sign.

All REMS products correspond with safety and accident prevention regulations and fulfil the respective appropriate European standards according to the terms of the EU directives. Additionally, with the exception of a few hand tools which are not safety relevant, all REMS products are checked and approved by independent testing agencies. All REMS products thereby meet an especially high standard with regard to work safety, functional safety and operational safety.



Permanent innovations in processes as well as investments in efficient CNC manufacturing systems engineering ensure that REMS products are amongst the best in the world.



Flexible assembly lines allow adjustment to the requirements of the customer at any time.

REMS is evaluated as having the largest number of training staff in the region. So it is able to maintain its own know-how at a high level.



Tightly defined test intervals during the whole manufacturing process as well as comprehensive function and safety checks after completion of the assembly ensure that no faulty product leaves the plant.

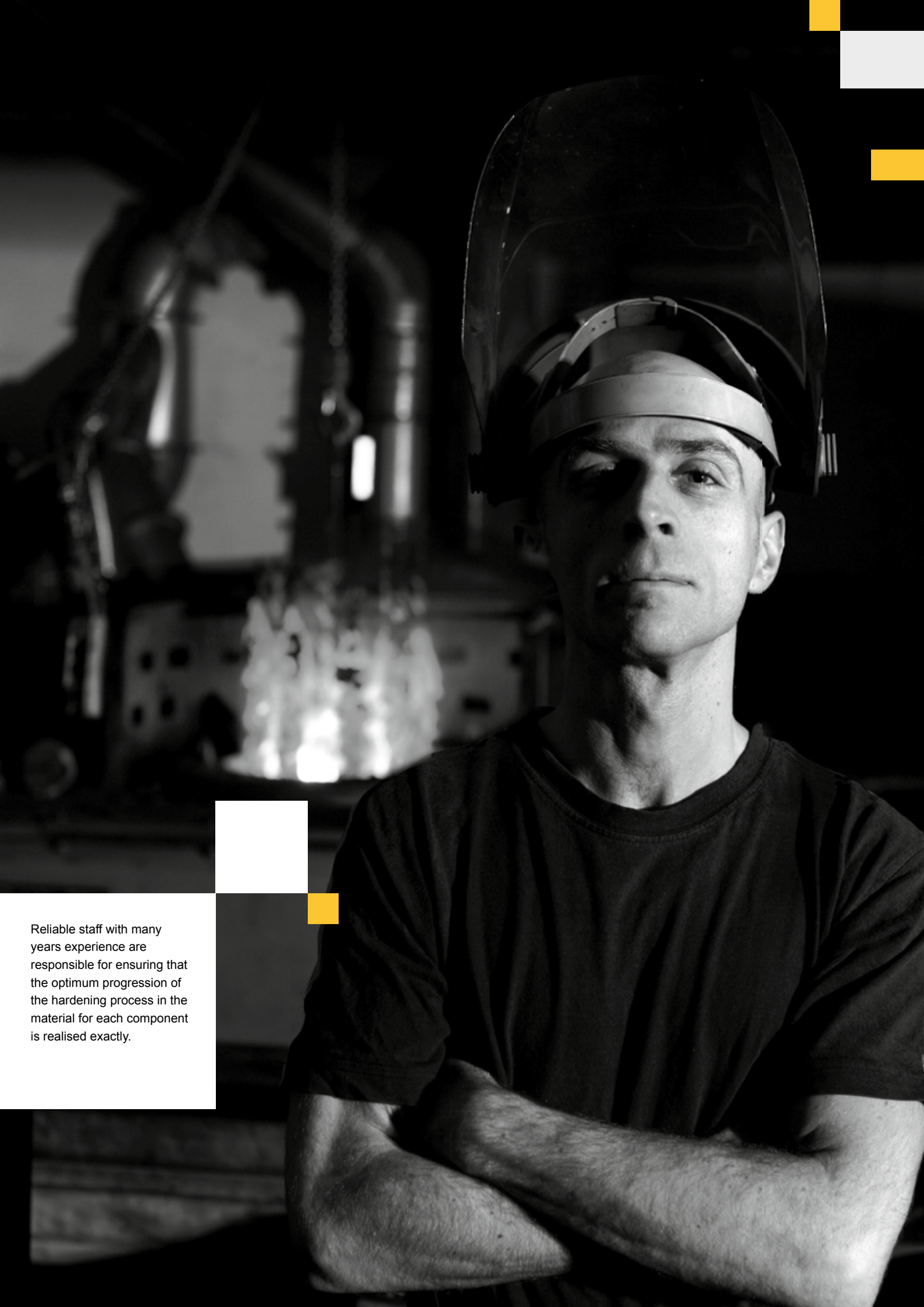

Reliable staff with many years experience are responsible for ensuring that the optimum progression of the hardening process in the material for each component is realised exactly.

Nobody hardens metal better than us. Therefore, we do it ourselves.

Highly durable, safe in application and extremely resilient – a tool can only meet such demands if the components are perfectly hardened.

An important cornerstone for the quality of REMS tools is laid in our own heat treatment shop. The decades of experience has provided important know-how and is the secret of REMS quality tools. The special heat treatment leads to an ideal combination of solidity and robustness and to an especially long durability, as, for example for threading dies, cutter wheels and pressing tongs. The heat treatment process is automatically monitored and permanently recorded by efficient computer technology. This allows a uniformly high product quality.



Our own heat treatment shop – an important aspect of the know-how and the secret of REMS quality tools.



The proven, indestructible REMS quality threading dies. Of robust, especially hardened special steel.



REMS cutter wheels complement the special demands of the various materials. In particular the special hardening process determines the durability of the REMS cutter wheels.



The art of hardening:
It creates extremely resilient components for the highest demands.



REMS
for Professionals

REMS
for Professionals

REMS
for Professionals

S

10

11

12

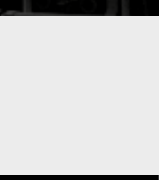

Only two from every 45 employees in the logistics industry know that time is money. Speed and absolute reliability are the most important factors for delivery and service.

REMS – for professionals.

Excellent service. On location everywhere.

REMS produces machines and tools for professionals – the demands required are high. REMS fulfils its tasks with competence, responsibility and a first-rate service. This also includes the swift delivery as well as maintenance and repair work. A high degree of flexibility and absolute reliability are the basis for the excellent service.

The whole logistics organisation is oriented towards the needs of our customers. In order to be able deliver promptly REMS keeps more than 10,000 items ready in the central storage facility. All wear and replacement parts are always available. A service that keeps down-times to a minimum.

In the case of a repair the area-wide network of contracted customer service workshops is available for a rapid and professional repair. Highly-qualified and well-trained staff repair and maintain the machines and tools for our customers. After completion of the repair or inspection the products are returned again to the customer by the fastest means.



Speed is a question of logistics. REMS keeps wear and replacement parts in stock in a 14,000 m² storage facility.



The demands at the building site are extreme – wear parts are worn, the need for repairs arises. The REMS customer services department is ready and flexible. There is an extensive service organisation in more than 25 countries.



Service is extremely important for REMS: All demonstration vehicles for the more than 200 REMS specialist advisors are fitted with testing equipment with which the function test and force of pressure measurement for REMS radial presses can be carried out on location everywhere.

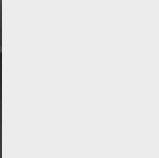

Product training in the
REMS training centre:
Become familiar with,
compare, evaluate.

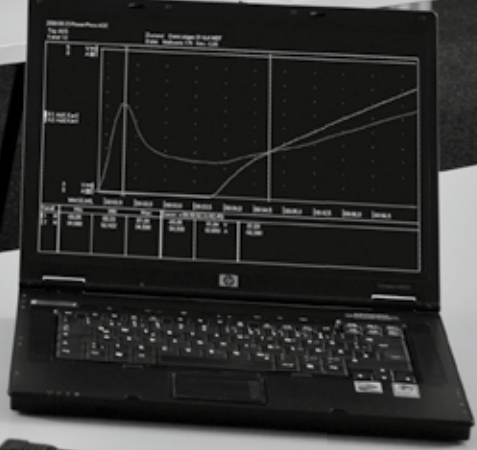

REMS – business partner to the trade.

Excellent advice for contented customers.

Only those who receive competent advice when purchasing find the individually best, economic solution for the tasks ahead. For this reason REMS assigns great significance to the product training of its own REMS specialist advisors and also the staff in the specialist stores.

In the REMS training centre, modern and fully-fitted demonstration, training and conference rooms are available in an area of 1,600 m². The practical-oriented training gives the staff of the specialist stores, in an understandable form, a broad basis and high specialist competence for product advice and successful sale. The detailed sales documentation with information relating to all necessary product specifications facilitate a swift product selection and are the basis for the simple and time-saving generation of offers.

This partnership with the specialist store also guarantees the user qualified, comprehensive product advice and excellent service.



REMS training centre in Waiblingen near Stuttgart.



Modern and fully-fitted demonstration rooms:
REMS creates many opportunities for the specialist-store staff to become familiar with the products.

Sascha Sammet, one of more than 200 qualified REMS specialist advisors is flexible and, when needed, swiftly on location for training courses and presentations.



REMS – Market strength through a consistent product and sales philosophy.

REMS' basis for market strength is technically-advanced and high-quality products as well as a product range tightly concentrated on high turnover units and highly competitive prices thanks to the rational, economical in-house production.

At the centre of the sales philosophy the principle has always been that REMS products are sold exclusively via specialist dealers. These are supported by REMS in many ways. REMS specialist advisors equipped with demonstration vehicles carry out product training on location and demonstrate the REMS products at on-site visits, counter demonstrations and at in-house exhibitions. They advise in the selection of the tools and find the most comfortable, reliable and economical solution in each individual situation.



The consistent sales philosophy is designed for long-term results, trust and predictability.



This is how installation professional become familiar with the product range in practice: The REMS specialist advisors are on the road with demonstration vehicles and demonstrate the machines and tools in real situations, directly on the building site.

The REMS product presentation system – the ideal opportunity for the specialist stores to optimally present the REMS products: touch – compare – select.

REMS



Touch. Compare. Select.

Promoting the mutual sale.

The participation at many national and international trade fairs, the advertising in trade magazines and the direct mail marketing to the user is highly valued by trade outlets as sales-promotion measures.

The attractive REMS product presentation system provides the trade outlet with an optimal presentation of the REMS products: Touch, compare, select. The individual stocking with REMS products is carried out with close cooperation between the REMS specialist advisors and the trade outlet.

The online information system at www.rems.de offers extensive opportunities to find out information about the REMS group, the REMS products and their application possibilities and operation. Furthermore, the user has access to the complete online catalogue and detailed technical documentation, information about current trade fair appearances and addresses of REMS contracted customer service workshops, download opportunities of sales documentation, operating instructions, parts lists, product illustrations and product films, opportunities to order sales documentation in various languages for postal dispatch, e-mail addresses for REMS contacts and much more.



The REMS products are exhibited and demonstrated at many national and international trade fairs.



Practical for the trade, clear for the customers – the REMS product presentation system.



The online information system at www.rems.de



REMS App





REMS products are highly valued and used across the world because of their innovative technology and high standards of quality. REMS products are available in all locations where perfection in installation work is demanded.

More than 20,000 trade partners in Europe: REMS products are available locally everywhere.

Innovative products and a high standard of quality open new markets for REMS.
In the last years the market area has been continuously build-up and extended.
Reliable trade partners throughout Europe and beyond guarantee that ever
more customers can be persuaded of the quality of REMS.



REMS sets benchmarks for quality throughout Europe – the sales are carried out through the tight network of reliable trade partners in the whole of Europe which are in turn supported by more than 200 well trained REMS specialist advisors.



Sales subsidiaries in many countries deliver optimum conditions for users and trade outlets.



Threading Roll Grooving

	Hand die stocks	22
	Quick-change die heads S	23
	Electric die stocks	24
	Threading machines	30
	Threading attachment	39
	Semi-automatic threading machines	40
	Pipe nipple chucks	46
	Thread-cutting oil	47
	Roll grooving attachments	48
	Roll grooving machines	50

Proven quality die stock with excellent threading capabilities.

Pipe threads	1/8–2", 16–50 mm
Bolt threads	6–30 mm, 1/4–1"

Thread types see page 28, 29.

REMS eva – the plumber's die stock.

Excellent start-cutting and threading.

Steel ratchet lever, thickly plastic coated.

Only one type of quick-change die heads.

Indestructible quality dies.

System advantage

Large working range up to 1 1/4" and up to 2" with only **one** ratchet lever. Only **one** type of small, compact quick-change die heads and only **one** type of dies. The same quick-change die heads fit all REMS die stocks and other suitable makes of die stocks. Efficient and easy stocking. No confusion possible.

Ratchet lever

Robust. Ratchet lever in steel, thickly plastic coated, for convenient operation. Serrated plastic handle for secure grip. Easy adjustment of ratchet rotation. Perfect, secure seating of quick-change die heads, fast and easy change.

Quick-change die heads

Proven technology, high-grade material and precise machining of die head, dies and cover form a unit and ensure an excellent start-cutting performance and easy threading. No stalling of dies. Long, precise pipe guidance for perfect pipe centering. The chip holes which become wider at the outside enable good chip flow and clean threads. Quick-change die heads S for cutting pipe threads in hard-to-reach areas (page 23).

Dies

The proven, indestructible REMS quality dies with precise cutting geometry ensure an excellent start-cutting performance, easy threading and clean threads. Dies in a high-quality special-grade steel, fully tempered and hardened, for extremely long die life.

Thread-cutting oil

REMS Sanitol and REMS Spezial (page 47). Specially developed for threading. High cooling and lubricating effect. Essential for clean threads and longer service life of dies, tools and machines.

Nipple-threading

Efficient with REMS Nippelspanner 3/8–2" (page 46).



German Quality Product

Supply format

REMS eva Set. Hand die stock with quick-change die heads. For pipe threads 1/8–2", 16–50 mm, bolt threads 6–30 mm, 1/4–1". For right and left-hand threads. 1 ratchet lever for the complete work range. Quick-change die heads with dies for pipe threads, tapered, ISO 7-1, EN 10226 (DIN 2999, BSPT) R right-hand respectively for threading electric conduit according to EN 60423 M. In sturdy steel case or in a cardboard box.

Description/Size	Art.-No.
REMS eva Set in steel case	
R 1/2–3/4-1	520014
R 1/2–3/4-1-1 1/4	520015
R 3/8–1/2–3/4-1-1 1/4	520013
R 1/2–3/4-1-1 1/4-1 1/2-2	520017
R 3/8–1/2–3/4-1-1 1/4-1 1/2-2	520016
M 16-20-25-32 (M x 1.5)	520010
M 20-25-32-40 (M x 1.5)	520009
REMS eva Set in cardboard box	
R 1/2–3/4	520008
R 1/2–3/4-1	520004
R 3/8–1/2–3/4-1-1 1/4	520003

REMS eva sets available for left-handed threads and NPT threads.

Accessories

Description	Art.-No.
Ratchet lever for complete work range	522000
Quick-change die heads S see page 23.	
Quick-change die heads, dies, attachment heads for button dies , see page 28–29.	
Steel case with inlay, for REMS eva 3/8–2"	526050
Thread-cutting oil see page 47.	
REMS Nippelspanner 3/8–2" see page 46.	
REMS Aquila 3B , pipe workstation with chain pipe vice on folding tripod stand, see page 92.	
REMS Aquila WB , chain pipe vice for workbench, see page 92.	



REMS quick-change die heads S

Accessories for REMS eva and other makes

For cutting pipe threads in hard-to-reach areas, e.g. caved wall, lay bare pipes, trench. Ideal for repair and renovation.

Pipe threads 3/8–1 1/4"

REMS quick-change die heads S – the trouble shooter for hard-to-reach areas.

Quick-change die heads S with specially mounted dies. Additional, precise pipe guidance at the cover side (Patent EP 0 875 327) ensure perfect pipe centering and easy start-cutting. Extension of ratchet drive REMS eva for threading in caved areas. Quick-change die heads S and extension fit into the ratchet lever REMS eva and other suitable die stocks.



German Quality Product



Supply format

Die heads S Set. choice of quick-change die heads S for pipe threads tapered, right-hand ISO 7-1, EN 10226 (DIN 2999, BSPT) respectively Taper Pipe Thread ASME B1.20.1, Extension 300 mm. In sturdy steel case.

Description	Art.-No.
Set R 3/8-1/2-3/4	520025
Set R 1/2-3/4-1	520026
Set NPT 1/2-3/4-1	520056



Accessories

Description	Size	Art.-No.
Ratchet lever for complete work range		522000
Quick-change die heads S		
Pipe threads tapered, right ISO 7-1, EN 10226 (DIN 2999, BSPT)	R 3/8	521026
	R 1/2	521036
	R 3/4	521046
	R 1	521056
	R 1 1/4	521066
Extension 300 mm		522051
Steel case with inlay for ratchet lever, 4 quick-change die heads S and extension.		526052



REMS Amigo E

Electric die stock with quick-change die heads

Powerful, super handy electric tools for threading with unique support bracket. Ready to use anywhere, without vice. Ideal for repair, renovation, job site.

Pipe threads	$\frac{1}{8}$ –1", 16–32 mm
Thread types see page 28, 29.	

REMS Amigo E – the fastest, strongest and lightest up to 1".

System advantage

Only **one** type of small, compact quick-change die heads and only **one** type of dies for all REMS die stocks. Thus efficient and easy stocking. No confusion possible.

Support bracket

Solid, easy to use, supports the die stock against torque in both directions. Secure clamping through angular clamping spindle with self-supporting effect. Very simple mounting of die stock onto support bracket and pipe.

Design

Compact, robust, job site-proven. Can be used anywhere, even without vice. Slender design for working in confined areas. Drive unit only 3.4 kg, without die head. No heavy top, therefore single-hand operation possible. Perfect, secure seating of quick-change die heads.

Drive

Solid, compact, maintenance-free gear. Robust, powerful 950 W universal motor with 30 % power increase thanks to automatic carbon brush adjustment while changing the direction of rotation. Peak power input up to 1500 W. Fast threading time 35–27 rpm. Safety tip switch.

Quick-change die heads

Proven technology, high-grade material and precise machining of die head, dies and cover form a unit and ensure an excellent start-cutting performance and easy threading. No stalling of dies. Long, precise pipe guidance for perfect pipe centering. The chip holes which become wider at the outside enable good chip flow and clean threads.

Dies

The proven, indestructible REMS quality dies with precise cutting geometry ensure an excellent start-cutting performance, easy threading and clean threads. Dies in a high-quality special-grade steel, fully tempered and hardened, for extremely long die life.

Thread-cutting oil

REMS Sanitol and REMS Spezial (page 47). Specially developed for threading. High cooling and lubricating effect. Essential for clean threads and longer service life of dies, tools and machines.

Nipple-threading

Efficient with REMS Nippelspanner $\frac{3}{8}$ –1" (2") (page 46).



German Quality Product

Tested by electrosuisse >>

Supply format

REMS Amigo E Set. Electric die stock with quick-change die heads. For pipe threads $\frac{1}{8}$ –1", 16–32 mm, bolt threads 6–30 mm, $\frac{1}{4}$ –1". For right and left-hand threads. Drive unit with maintenance-free gear, powerful universal motor 230 V or 110 V, 50–60 Hz, 950 W, safety tip switch, power increase thanks to automatic carbon brush adjustment. Peak power input up to 1500 W. Right and left-hand rotation. Support bracket for both directions. REMS eva quick-change die heads for pipe threads, tapered, ISO 7-1, EN 10226 (DIN 2999, BSPT) R right-hand respectively for threading electric conduit according to EN 60423 M. In sturdy steel case.

Description	Art.-No.
Set R $\frac{1}{2}$ – $\frac{3}{4}$ -1	530013
Set M 20-25-32	530014

REMS Amigo E Set for NPT threads available.



Accessories

Description	Art.-No.
Quick-change die heads, dies, attachment heads for button dies, see page 28–29.	
REMS Amigo E drive unit	530003
Support bracket	533000
REMS REG St $\frac{1}{4}$ –2", pipe deburrer, see page 85.	731700
Dual purpose holder for threading and sawing with REMS Amigo E, Amigo, Amigo 2 and REMS Tiger ANC	543100
Ratchet lever see page 22.	522000
Thread-cutting oil see page 47.	
REMS Nippelspanner $\frac{3}{8}$ –2" see page 46.	
Steel case with inlay	536000



REMS Amigo

Electric die stock with quick-change die heads

Powerful, easy-to-operate electric tool for threading with unique support bracket. Ready for use anywhere, without vice. Ideal for repair, renovation, job site.

Pipe threads	$\frac{1}{8}$ – $1\frac{1}{4}$ ", 16–40 mm
Bolt threads	6–30 mm, $\frac{1}{4}$ – $1"$
Thread types see page 28, 29.	

REMS Amigo – the smallest, lightest, strongest and fastest up to $1\frac{1}{4}$ ".

System advantage

Only **one** type of small, compact quick-change die heads and only **one** type of dies for all REMS die stocks. Thus efficient and easy stocking. No confusion possible.

Support bracket

Solid, easy to use, supports the die stock against torque in both directions. Secure clamping through angular clamping spindle with self-supporting effect. Very simple mounting of die stock onto support bracket and pipe.

Design

Compact, robust, job site-proven. Can be used anywhere, even without vice. Slender design for working in confined areas. Drive unit only 3.5 kg, without die head. No heavy top, therefore single-hand operation possible. Perfect, secure seating of quick-change die heads.

Drive

Solid, compact, maintenance-free gear. Robust, powerful 1200 W universal motor with 30 % power increase thanks to automatic carbon brush adjustment while changing the direction of rotation. Peak power input up to 1800 W. Fast threading time 35–27 rpm. Safety tip switch.

Quick-change die heads

Proven technology, high-grade material and precise machining of die head, dies and cover form a unit and ensure an excellent start-cutting performance and easy threading. No stalling of dies. Long, precise pipe guidance for perfect pipe centering. The chip holes which become wider at the outside enable good chip flow and clean threads.

Dies

The proven, indestructible REMS quality dies with precise cutting geometry ensure an excellent start-cutting performance, easy threading and clean threads. Dies in a high-quality special-grade steel, fully tempered and hardened, for extremely long die life.

Thread-cutting oil

REMS Sanitol and REMS Spezial (page 47). Specially developed for threading. High cooling and lubricating effect. Essential for clean threads and longer service life of dies, tools and machines.

Nipple-threading

Efficient with REMS Nippelspanner $\frac{3}{8}$ – $1\frac{1}{4}$ " (2") (page 46).



German Quality Product

Tested by electrosuisse >>>

Supply format

REMS Amigo Set. Electric die stock with quick-change die heads. For pipe threads $\frac{1}{8}$ – $1\frac{1}{4}$ ", 16–40 mm, bolt threads 6–30 mm, $\frac{1}{4}$ – $1"$. For right and left-hand threads. Drive unit with maintenance-free gear, powerful universal motor 230 V or 110 V, 50–60 Hz, 1200 W, safety tip switch, power increase thanks to automatic carbon brush adjustment. Peak power input up to 1800 W. Right and left-hand rotation, overload protection switch. Support bracket for both directions. REMS eva quick-change die heads for pipe threads, tapered, ISO 7-1, EN 10226 (DIN 2999, BSPT) R right-hand respectively for threading electric conduit according to EN 60423 M. In sturdy steel case.

Description	Art.-No.
Set R $\frac{1}{2}$ – $\frac{3}{4}$ – $1\frac{1}{4}$	530020
Set M 16–20–25–32 (M × 1,5)	530022
Set M 20–25–32–40 (M × 1,5)	530023

REMS Amigo Set for NPT threads available.

Accessories

Description	Art.-No.
Quick-change die heads, dies, attachment heads for button dies, see page 28–29.	
REMS Amigo drive unit	530000
Support bracket	533000
REMS REG St $\frac{1}{4}$–$2"$, pipe deburrer, see page 85.	731700
Dual purpose holder for threading and sawing with REMS Amigo E, Amigo, Amigo 2 and REMS Tiger ANC	543100
Ratchet lever see page 22.	522000
Thread-cutting oil see page 47.	
REMS Nippelspanner $\frac{3}{8}$–$2"$ see page 46.	
Steel case with inlay	536000



REMS Amigo 2 Compact

Electric die stock with quick-change die heads

Powerful, easy-to-operate electric tool for threading with unique support bracket. Ready for use any-where, without vice. Ideal for repair, renovation, job site.

Pipe threads $\frac{1}{8}$ –2", 16–50 mm
Bolt threads 6–30 mm, $\frac{1}{4}$ –1"

Thread types see page 28, 29.

REMS Amigo 2 Compact – The smallest and lightest up to 2".

System advantage

Only **one** type of small, compact quick-change die heads and only **one** type of dies for all REMS die stocks. Thus efficient and easy stocking. No confusion possible.

Support bracket

Solid, easy to use, supports the die stock against torque in both directions. Secure clamping through angular clamping spindle with self-supporting effect. Very simple mounting of die stock onto support bracket and pipe.

Design

Compact, robust, job site-proven. Can be used anywhere, even without vice. Slender design for working in confined areas. Drive unit only 4.9 kg, without die head. Perfect seating of quick-change die heads.

Drive

Solid, maintenance-free gear. Robust 1200 W universal motor with 30 % power increase thanks to automatic carbon brush adjustment while changing the direction of rotation. Peak power input up to 1800 W. Fast threading time 30–18 rpm. Safety tip switch.

Quick-change die heads

Proven technology, high-grade material and precise machining of die head, dies and cover form a unit and ensure an excellent start-cutting performance and easy threading. No stalling of dies. Long, precise pipe guidance for perfect pipe centering. The chip holes which become wider at the outside enable good chip flow and clean threads.

Dies

The proven, inducturable REMS quality dies with precise cutting geometry ensure an excellent start-cutting performance, easy threading and clean threads. Dies in a high-quality special-grade steel, fully tempered and hardened, for extremely long die life.

Thread-cutting oil

REMS Sanitol and REMS Spezial (page 47). Specially developed for threading. High cooling and lubricating effect. Essential for clean threads and longer service life of dies, tools and machines.

Nipple-threading

Efficient with REMS Nippelspanner $\frac{3}{8}$ –1" (2") (page 46).



German Quality Product



Tested by electrosuisse

Supply format

REMS Amigo 2 Compact Set. Electric die stock with quick-change die heads. For pipe threads $\frac{1}{8}$ –2", 16–50 mm, bolt threads 6–30 mm, $\frac{1}{4}$ –1". For right and left-hand threads. Drive unit with maintenance-free gear, powerful universal motor 230 V or 110 V, 50–60 Hz, 1200 W, safety tip switch, power increase thanks to automatic carbon brush adjustment. Peak power input up to 1800 W. Right and left-hand rotation. Overload protection. Support bracket for both directions. REMS eva quick-change die heads for pipe threads, tapered, ISO 7-1, EN 10226 (DIN 2999, BSPT) R right-hand respectively for threading electric conduit according to DIN DN 60423 M. In sturdy steel case.

Description	Art.-No.
Set R $\frac{1}{2}$ – $\frac{3}{4}$ –1–1 $\frac{1}{4}$	540023
Set R $\frac{1}{2}$ – $\frac{3}{4}$ –1–1 $\frac{1}{4}$ –1 $\frac{1}{2}$ –2	540024
Set M 20–25–32–40–50 (M × 1,5)	540025

REMS Amigo 2 Compact Set for NPT threads available.
Other voltages on request.



Accessories

Description	Art.-No.
Quick-change die heads, dies, attachment heads for button dies, see page 28–29.	
REMS Amigo 2 Compact drive unit	540001
Support bracket Amigo 2 Compact	543010
REMS REG St $\frac{1}{4}$–2" , pipe deburrer, see page 85.	731700
Ratchet lever see page 22.	522000
Thread-cutting oil see page 47.	
REMS Nippelspanner $\frac{3}{8}$–2" see page 46.	
Steel case with inlay	546000



REMS quick-change die heads

Accessories for REMS die stocks and other makes

REMS quick-change die heads

Proven technology, high-grade material and precise machining of die head, dies and cover form a unit and ensure an excellent start-cutting performance and easy threading. No stalling of dies. Long, precise pipe guidance for perfect pipe centering. The chip holes which become wider at the outside enable good chip flow and clean threads.

Thread type	Size	Art.-No.
Pipe threads R tapered, right-hand ISO 7-1, EN 10226 (DIN 2999, BSPT)	R 1/8	521000
	R 1/4	521010
	R 3/8	521020
	R 1/2	521030
	R 3/4	521040
	R 1	521050
	R 1 1/4	521060
	R 1 1/2	521070
	R 2	521080
Pipe threads R tapered, left-hand ISO 7-1, EN 10226 (DIN 2999, BSPT)	R 1/8 LH	521100
	R 1/4 LH	521110
	R 3/8 LH	521120
	R 1/2 LH	521130
	R 3/4 LH	521140
	R 1 LH	521150
	R 1 1/4 LH	521160
	R 1 1/2 LH	521170
	R 2 LH	521180
Pipe threads NPT tapered, right-hand Taper Pipe Thread ASME B1.20.1	NPT 1/8	521200
	NPT 1/4	521210
	NPT 3/8	521220
	NPT 1/2	521230
	NPT 3/4	521240
	NPT 1	521250
	NPT 1 1/4	521260
	NPT 1 1/2	521270
	NPT 2	521280
Threads M for electric conduit EN 60423	M 16 x 1.5	521300
	M 20 x 1.5	521310
	M 25 x 1.5	521320
	M 32 x 1.5	521330
	M 40 x 1.5	521340
	M 50 x 1.5	521350



Right-hand pipe thread



Left-hand pipe thread



German Quality Product

REMS dies

Accessories for REMS die stocks

REMS dies

The proven, indestructible REMS quality dies with precise cutting geometry ensure an excellent start-cutting performance, easy threading and clean threads. Dies in a high-quality special-grade steel, fully tempered and hardened, for extremely long die life.

Thread type	Size	Art.-No.
Pipe threads R tapered, right-hand ISO 7-1, EN 10226 (DIN 2999, BSPT)	R 1/8	521002
	R 1/4	521012
	R 3/8	521022
	R 1/2	521032
	R 3/4	521042
	R 1	521052
	R 1 1/4	521062
	R 1 1/2	521072
	R 2	521082
Pipe threads R tapered, left-hand ISO 7-1, EN 10226 (DIN 2999, BSPT)	R 1/8 LH	521102
	R 1/4 LH	521112
	R 3/8 LH	521122
	R 1/2 LH	521132
	R 3/4 LH	521142
	R 1 LH	521152
	R 1 1/4 LH	521162
	R 1 1/2 LH	521172
	R 2 LH	521182
Pipe threads NPT tapered, right-hand Taper Pipe Thread ASME B1.20.1	NPT 1/8	521202
	NPT 1/4	521212
	NPT 3/8	521222
	NPT 1/2	521232
	NPT 3/4	521242
	NPT 1	521252
	NPT 1 1/4	521262
	NPT 1 1/2	521272
	NPT 2	521282
Threads M for electric conduit EN 60423	M 16 x 1.5	521302
	M 20 x 1.5	521312
	M 25 x 1.5	521322
	M 32 x 1.5	521332
	M 40 x 1.5	521342
	M 50 x 1.5	521352



German Quality Product

Attachment heads for button dies / intermediate rings / guide bushings

Accessories for REMS die stocks and other makes

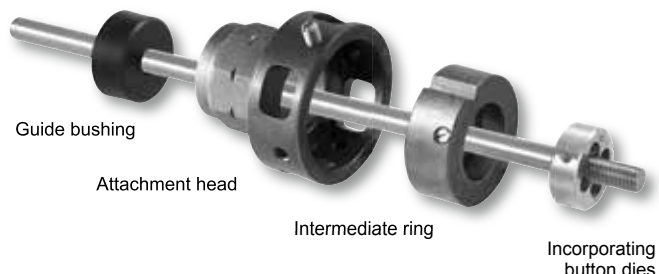

Attachment heads

Attachment heads for incorporating standard, round button dies of all thread types. Locking of button dies to the attachment head with stud bolt.

Description	Size	Art.-No.
Attachment head for button dies	Ø 65 mm	731200
Attachment head for button dies	G 1 1/4	731250
Attachment head for button dies	Ø 105 mm	541401

Intermediate rings

Intermediate rings for different outside diameters of button dies.

Description	Size	I.D. mm	Art.-No.
Intermediate rings to attachment head 731200	M 6-9		731205
	20/25		731210
	M 10-11	30	731220
	M 12-14 (Pg 7-9)	38	731230
	M 16-20 (Pg 11-13.5)	45	731240
without intermediate ring	M 22-24 (Pg 16)	55	
	M 27-30 (Pg 21-29)	65	
Intermediate rings to attachment head 541401	Ø 65/105 (Pg 21-29)	65	541404
	Ø 75/105	75	541406
	Ø 90/105 (Pg 36)	90	541410
without intermediate ring	Pg 42-48	105	

Guide bushings

Guide bushings for easy and concentric start-cutting.

Description	Size	Art.-No.
Guide bushings to attachment head 731200	Ø 6	731301
	Ø 8	731302
	Ø 10	731303
	Ø 12	731304
	Ø 14	731305
	Ø 16	731306
	Ø 18	731307
	Ø 20	731308
	Ø 22	731309
	Ø 24	731310
	Ø 27	731311
	Ø 30	731312
	Ø 12.8 (Pg 7)	731320
	Ø 15.5 (Pg 9)	731321
	Ø 18.9 (Pg 11)	731322
	Ø 20.7 (Pg 13.5)	731323
	Ø 22.8 (Pg 16)	731324
Ø 28.6 (Pg 21)	731325	
Ø 37.3 (Pg 29)	731326	
Guide bushings to attachment head 541401	Ø 28.6 (Pg 21)	541413
	Ø 37.3 (Pg 29)	541414
	Ø 47.3 (Pg 36)	541415
	Ø 54.3 (Pg 42)	541416



German Quality Product

Proven high performance machine for threading, cutting, deburring, threading of nipples, roll grooving.

For installation, metalworking, industry.

For job site and workshop.

Pipe threads (1/16) 1/8–2", 16–63 mm

Bolt threads (6) 10–60 mm, 1/4–2"

Pipe threads with REMS 4" automatic die head 2 1/2–4"

Thread types see page 38.

Pipe grooving with
REMS roll grooving attachment DN 25–300
1–12"

REMS Tornado – a class of its own.

Automatic chuck. Universal automatic die head.

Automatic lubrication and cooling.

Operating principle

Rotating material - stationary tools.

Design

Robust, job site-proven. Favourable size and weight, e.g. REMS Tornado 2000 complete only 50 kg. Large work and chip compartment. Easy handling of chip tray. Adjustable height material support.

2 versions:

- Portable version with 3 tubular legs, with removable large oil basin and chip tray.
- Version T with integrated, even larger oil basin and chip tray. For workbench. Stand, collapsible wheel stand or wheel stand with material shelf, as an accessory, for easy transport, optimum working height and stable positioning.

Drive

Extremely powerful and fast, e.g. R 2" thread in only 15 s. Completely maintenance-free gear which runs in a sealed oil bath.

Choice of 3 powerful motors:

- Strong universal motor, 1700 W. overload protection. Spindle speed 53 rpm.
- Pole-reversible capacitor motor, 2100 W. Overload protection. 2 spindle speeds 52 and 26 rpm, also under full load. **Extremely quiet running.**
- Pole-reversible 3~induction motor, 2000 W. Overload protection. 2 spindle speeds 52 and 26 rpm, also under full load. **Extremely quiet running.**

Operator-friendly safety foot switch with emergency-stop, 2-step. Foot switch, can be loaded with the full body weight during operation.

Automatic chuck

2 automatic chucks with self-centering clamping jaws for easy and fast clamping and release of the material. Self-tightening, hence maximum clamping force. No slipping of pipes.

Automatic lubrication and cooling

Robust, proven oil pump with high pumping volume. Optimized oil distribution directly onto the threading point through the die head ensures clean threads and long service life of dies, gear and motor.

Universal automatic die head

Only **one** universal automatic die head for all threads, including long threads; automatic opening with automatic thread-length-stop for tapered threads. Fast and easy adjustment of thread size. Easy-to-read thread-size scale. Simple and fast change of dies through lock-in positioning in die holder.

Dies

The proven, indestructible REMS quality dies with precise cutting geometry ensure an excellent start-cutting performance, easy threading and clean threads. Dies in a high-quality special-grade steel, fully tempered and hardened, for extremely long die life.

Pipe cutter

Self centering. Robust body made of forged steel. Ergonomic, wide handle for powerful infeed of spindle. Specially hardened cutter wheel in tough-hard REMS die-steel ensures long service life.

Inner pipe deburrer

Robust, easy-to-handle deburring device with adjustable deburring positioning. Specially hardened and designed deburring blade ensures easy deburring and extremely long service life. Two cutting edges for optimum chip flow, specially for small diameters.

Thread-cutting oil

REMS Sanitol and REMS Spezial (page 47). Specially developed for threading. High cooling and lubricating effect. Essential for clean threads and longer service life of dies, tools and machines.

REMS 4" automatic die head

for pipe threads 2 1/2–4" (page 39).



German Quality Product



Choice of 3 powerful motors.



Nipple-threading

Efficient with the automatic internal clamping REMS Nippelfix 1/2–2" (4") or with the manual internal clamping REMS Nippelspanner 3/8–2" (page 46).

REMS roll grooving attachment

Robust, compact roll grooving attachment with oil hydraulic in-feed for pipe grooving of grooved coupling systems DN 25–300, 1–12" (page 48).



Wheel stand (accessory)



Collapsible wheel stand (Accessory)

Supply format

REMS Tornado. Threading machine for pipe threads ($1/16$) $1/8$ –2", 16–63 mm, bolt threads (6) 10–60 mm, $1/4$ –2". With maintenance-free gear, safety foot switch with emergency-stop, 2 automatic chucks, automatic lubrication and cooling. With tool set consisting of one universal automatic die head for all threads, also long threads, automatic opening, with automatic thread-length-stop for tapered threads. Dies for pipe threads, tapered, ISO 7-1, EN 10226 (DIN 2999, BSPT) R $1/2$ – $3/4$ " and R 1–2" right-hand, pipe cutter, inner pipe deburrer, pressing lever, adjustable height material support. Choice of 3 motors. Portable version with 3 tubular legs, with removable, large oil and chip tray. Version T with integrated, even bigger oil tray and chip tray, for workbench, stand, collapsible wheel stand or wheel stand with material shelf. In a carton.

Description	Version	Art.-No.
2000	Universal motor 230 V or 110 V, 50–60 Hz, 1700 W. 53 rpm. Portable, 3 legs.	340200
2010	Pole-reversible capacitor, motor 230 V, 50 Hz, 2100 W. 52/26 rpm, also under full load. Extremely quiet running. Portable, 3 legs.	340201
2020	Pole-reversible 3~ induction motor 400 V, 50 Hz, 2000 W. 52/26 rpm, also under full load. Extremely quiet running. Portable, 3 legs.	340202
2000 T	Universal motor 230 V or 110 V, 50–60 Hz, 1700 W. 53 rpm For work bench, stand or wheel stand.	340206
2010 T	Pole-reversible capacitor motor 230 V, 50 Hz, 2100 W. 52/26 rpm, also under full load. Extremely quiet running. For work bench, stand or wheel stand.	340207
2020 T	Pole-reversible 3~ induction motor 400 V, 50 Hz, 2000 W. 52/26 rpm, also under full load. Extremely quiet running. For work bench, stand or wheel stand.	340208

Other voltages and NPT versions on request.

Accessories

Description	Art.-No.
Stand	344105
Wheel stand with material shelf	344100
Collapsible wheel stand	344150
Dies see page 38.	
Universal automatic die head $1/16$–2" quick-change die head instead of changing the dies	341000
REMS 4" automatic die head for pipe threads 2 1/2–4", see page 39.	
REMS cutter wheel St $1/8$–4", s 8	341614
Thread-cutting oil see page 47.	
Nipple holder see page 46.	
REMS Herkules material supports, see page 94.	
REMS roll grooving attachment for pipe grooving, see page 48.	347000



Robust, compact high performance machine for threading, cutting, deburring, threading of nipples, roll grooving. For installation, metalworking, industry. For job site and workshop.

Pipe threads $(\frac{1}{16}) \frac{1}{8}$ –2", 16–63 mm

Bolt threads (6) 8–60 mm, $\frac{1}{4}$ –2"

Pipe threads with REMS 4" automatic die head $2\frac{1}{2}$ –4"

Thread types see page 38.

Grooving of pipes with
REMS roll grooving attachment DN 25–300
1–12"

REMS Magnum – the compact up to 2".

Operating principle

Rotating material – stationary tools.

Design

Robust, compact, job site-proven design. Favorable size and weight, e.g. REMS Magnum 2000 L-T only 57 kg. Large work and chip compartment. Tool support.

2 versions:

- Light version L-T with removable large oil basin and chip tray.
 - Version T with integrated, even larger oil basin and chip tray.
- For workbench. Stand, collapsible wheel stand or wheel stand with material shelf, as an accessory, for easy transport, optimum working height and stable positioning.

Drive

Extremely powerful and fast, e.g. thread R 2" in only 15 s. Completely maintenance-free gear which runs in a sealed oil bath.

Choice of 3 powerful motors:

- Strong universal motor, 1700 W. Overload protection. Spindle speed 53 rpm.
- Pole-reversible capacitor motor, 2100 W. Overload protection. 2 spindle speeds 52 and 26 rpm, also under full load. **Extremely quiet running.**
- Pole-reversible 3~ induction motor, 2000 W. Overload protection. 2 spindle speeds 52 and 26 rpm, also under full load. **Extremely quiet running.**

Operator-friendly safety foot switch with emergency-stop, 2-step. Foot switch, can be loaded with the full body weight during operation.

Chuck

Proven quick-action hammer chuck, self-tightening. No slipping of pipes. Large space between chuck and centering device ensures secure clamping of long pipes. Rear centering device for alignment of the material.

Automatic lubrication and cooling

Robust, proven oil pump with high pumping volume. Optimized oil distribution directly onto the threading point through the die head ensures clean threads and long service life of dies, gear and motor.

Universal automatic die head

Only **one** universal automatic die head for all threads, including long threads; automatic opening with automatic thread-length-stop for tapered threads. Fast and easy adjustment of thread size. Simple and fast change of dies through lock-in positioning in die holder.

Dies

The proven, indestructible REMS quality dies with precise cutting geometry ensure an excellent start-cutting performance, easy threading and clean threads. Dies in a high-quality special-grade steel, fully tempered and hardened, for extremely long die life.

Pipe cutter

Self centering. Robust body made of forged steel. Ergonomic, wide handle for powerful infeed of spindle. Specially hardened cutter wheel in tough-hard REMS die-steel ensures long service life.

Inner pipe deburrer

Robust, easy-to-handle deburring device for adjustable deburring positioning. Specially hardened and designed deburring blade ensures easy deburring and extremely long service life. Two cutting edges for optimum chip flow, specially for small diameters.

Thread-cutting oil

REMS Sanitol and REMS Spezial (page 47). Specially developed for threading. High cooling and lubricating effect. Essential for clean threads and longer service life of dies, tools and machines.

REMS 4" automatic die head

for pipe threads $2\frac{1}{2}$ –4" (page 39).

Nipple-threading

Efficient with automatic internal clamping REMS Nippelfix $\frac{1}{2}$ –2" (4") or with manual internal clamping REMS Nippelspanner $\frac{3}{8}$ –2" (page 46).

REMS roll grooving attachment

Robust, compact roll grooving attachment with oil hydraulic in-feed for pipe grooving of grooved coupling systems DN 25–300, 1–12" (page 48).



German Quality Product



Choice of 3 powerful motors.





Stand (Accessory)



Wheel stand (accessory)



Collapsible wheel stand (Accessory)

Supply format

REMS Magnum. Threading machine for pipe threads ($1/16$) $1/8$ -2", 16-63 mm, bolt thread (6)8-60 mm, $1/4$ -2". With maintenance-free gear, safety foot switch with emergency-stop, self-tightening quick-action hammer chuck, rear centering device, automatic lubrication and cooling. With complete tool set consisting of one universal automatic die head for all threads, also long threads; automatic opening, with automatic thread-length-stop for tapered threads, dies for pipe threads, tapered, ISO 7-1, EN 10226 (DIN 2999, BSPT) R $1/2$ - $3/4$ " and R 1-2" right-hand, pipe cutter, inner pipe deburrer, pressing lever. Tool support. Choice of 3 motors. Version L-T with removable large oil basin and chip tray. Version T with integrated, even bigger oil tray and chip tray. For workbench, stand, collapsible wheel stand or wheel stand with material shelf. In a carton.

Description	Version	Art.-No.
2000 L-T	Universal motor 230 V or 110 V, 50-60 Hz, 1700 W. 53 rpm.	340226
2010 L-T	Pole-reversible capacitor motor 230 V, 50 Hz, 2100 W. 52/26 rpm, also under full load. Extremely quiet running.	340227
2020 L-T	Pole-reversible 3~ induction motor 400 V, 50 Hz, 2000 W. 52/26 rpm, also under full load. Extremely quiet running.	340228
2000 T	Universal motor 230 V or 110 V, 50-60 Hz, 1700 W. 53 rpm.	340220
2010 T	Pole-reversible capacitor motor 230 V, 50 Hz, 2100 W. 52/26 rpm, also under full load. Extremely quiet running.	340221
2020 T	Pole-reversible 3~ induction motor 400 V, 50 Hz, 2000 W. 52/26 rpm, also under full load. Extremely quiet running.	340222

Other voltages and NPT versions on request.

Accessories

Description	Art.-No.
Stand	344105
Wheel stand with material shelf	344100
Collapsible wheel stand	344150
Dies see page 38.	
Universal automatic die head $1/16$-2" quick-change die head instead of changing the dies	341000
REMS 4" automatic die head for pipe threads 2 $1/2$ -4", see page 39.	
REMS cutter wheel St $1/8$-4", s 8	341614
Thread-cutting oil see page 47.	
Nipple holder see page 46.	
REMS Herkules material supports, see page 94.	
REMS roll grooving attachment for pipe grooving, see page 48.	347000



Robust, compact high performance machine for threading, cutting, deburring, threading of nipples, roll grooving. For installation, metalworking, industry. For job site and workshop.

Pipe threads (1/16) 1/2–3", 16–63 mm
Bolt threads (6) 20–60 mm, 1/2–2"

Thread types see page 38.

Pipe grooving
with REMS roll grooving attachment DN 25–300
1–12"

**REMS Magnum – the super machine up to 3".
Exceptionally round and clean threads up to 3"
by using 5 threading dies.**

Operating principle

Rotating material – stationary tools.

Design

Robust, compact, job site-proven design. Favorable size and weight, e.g. REMS Magnum 3000 L-T only 79 kg. Large work and chip compartment. Tool support.

2 versions:

- Light version L-T with removable large oil basin and chip tray.
 - Version T with integrated, even larger oil basin and chip tray.
- For workbench. Stand, collapsible wheel stand or wheel stand with material shelf, as an accessory, for easy transport, optimum working height and stable positioning.

Drive

Extremely powerful and fast. Completely maintenance-free gear which runs in a sealed oil bath.

Choice of 3 powerful motors:

- Strong universal motor, 1700 W.
Overload protection. Spindle speed 23 rpm.
- Pole-reversible capacitor motor, 2100 W.
Overload protection. 2 spindle speeds 20 and 10 rpm, also under full load. **Extremely quiet running.**
- Pole-reversible 3~ induction motor, 2000 W.
Overload protection. 2 spindle speeds 20 and 10 rpm, also under full load. **Extremely quiet running.**

Operator-friendly safety foot switch with emergency-stop, 2-step.
Foot switch, can be loaded with the full body weight during operation.

Chuck

Proven quick-action hammer chuck, self-tightening. No slipping of pipes.
Large space between chuck and centering device ensures secure clamping of long pipes. Rear centering device for alignment of the material.

Automatic lubrication and cooling

Robust, proven oil pump with high pumping volume. Optimized oil distribution directly onto the threading point through the die head ensures clean threads and long service life of dies, gear and motor.

Universal automatic die head

Only 1 universal automatic die head each for the sizes 1/16–2" and 2 1/2–3" for all threads, including long threads; automatic opening with automatic thread-length-stop for tapered threads. 5 dies 2 1/2–3" ensure a favourable distribution of the cutting force onto the pipe, hence round and clean threads. Fast and easy adjustment of thread size. Simple and fast change of dies through lock-in positioning in die holder.

Dies

The proven, indestructible REMS quality dies with precise cutting geometry ensure an excellent start-cutting performance, easy threading and clean threads. Dies in a high-quality special-grade steel, fully tempered and hardened, for extremely long die life.

Pipe cutter

Self centering. Robust body made of forged steel. Ergonomic, wide handle for powerful infeed of spindle. Specially hardened cutter wheel in tough-hard REMS die-steel ensures long service life.

Inner pipe deburrer

Robust, easy-to-handle deburring device for adjustable deburring positioning. Specially hardened and designed deburring blade ensures easy deburring and extremely long service life. Two cutting edges for optimum chip flow, specially for small diameters.

Tool sets

For 2 1/2–3" and 1/4–2" one complete tool set each adapted to the work range with universal die head, pipe cutter, inner-pipe-deburring device, pressing lever, dies.



German Quality Product



Choice of 3 powerful motors.



Thread-cutting oil

REMS Sanitol and REMS Spezial (page 47). Specially developed for threading. High cooling and lubricating effect. Essential for clean threads and longer service life of dies, tools and machines.

Nipple-threading

Efficient with automatic internal clamping REMS Nippelfix ½–3" (4") or with manual internal clamping REMS Nippelspanner (page 46).

REMS roll grooving attachment

Robust, compact roll grooving attachment with oil hydraulic in-feed for pipe grooving of grooved coupling systems DN 25–300, 1–12" (page 48).

Supply format

REMS Magnum. Threading machine for pipe threads ($\frac{1}{16}$ –3", 16–63 mm, bolt threads (6) 20–60 mm, $\frac{1}{2}$ –2". With maintenance-free gear, safety foot switch with emergency-stop, self-tightening quick-action hammer chuck, rear centering device, automatic lubrication and cooling. With tool sets $\frac{1}{16}$ –2" and/or 2½–3", each consisting of universal automatic die head for all threads, also long threads; automatic opening, with automatic thread-length-stop for tapered threads, dies for pipe threads, tapered, ISO 7-1, EN 10226 (DIN 2999, BSPT) R right-hand, pipe cutter, inner pipe deburrer, pressing lever. Tool support. Choice of 3 motors. Version L-T with removable large oil basin and chip tray. Version T with integrated, even larger oil basin and chip tray. For workbench, stand, collapsible wheel stand or wheel stand with material shelf.

Description	Version/Equipment	Art.-No.
3000 L-T	Universal motor 230 V or 110 V, 50–60 Hz, 1700 W. 23 rpm.	
	Equipment R 2½–3 Equipment R ½–3	380303 380309
3010 L-T	Pole-reversible capacitor motor 230 V, 50 Hz, 2100 W. 20/10 rpm, also under full load. Extremely quiet running.	
	Equipment R 2½–3 Equipment R ½–3	380304 380310
3020 L-T	Pole-reversible 3~ induction motor 400 V, 50 Hz, 2000 W. 20/10 rpm, also under full load. Extremely quiet running.	
	Equipment R 2½–3 Equipment R ½–3	380305 380311
3000 T	Universal motor 230 V or 110 V, 50–60 Hz, 1700 W. 23 rpm.	
	Equipment R 2½–3 Equipment R ½–3	380306 380312
3010 T	Pole-reversible capacitor motor 230 V, 50 Hz, 2100 W. 20/10 rpm, also under full load. Extremely quiet running.	
	Equipment R 2½–3 Equipment R ½–3	380307 380313
3020 T	Pole-reversible 3~ induction motor 400 V, 50 Hz, 2000 W. 20/10 rpm, also under full load. Extremely quiet running.	
	Equipment R 2½–3 Equipment R ½–3	380308 380314

Other voltages and NPT versions on request.

Accessories

Description	Art.-No.
Stand	344105
Wheel stand with material shelf	344100
Collapsible wheel stand	344150
Dies see page 38.	
Tool set $\frac{1}{16}$–2" complete with universal automatic die head, dies for pipe threads, tapered, ISO 7-1, EN 10226 (DIN 2999, BSPT) R ½–¾" and R 1–2" right-hand, pipe cutter, inner pipe deburrer, pressing lever.	340100
Universal automatic die head $\frac{1}{16}$–2" and others	341000
Universal automatic die head 2½–3"	381050
Universal automatic die head 2½–4"	381000
REMS cutter wheel St ½–4", s 8	341614
REMS cutter wheel St 1–4", s 12	381622
Thread-cutting oil see page 47.	
Nipple holder see page 46.	
REMS Herkules material supports, see page 94.	
REMS roll grooving attachment for pipe grooving, see page 48.	347000



Stand (Accessory)



Wheel stand (accessory)



Collapsible wheel stand (Accessory)



Robust, compact high performance machine for threading, cutting, deburring, threading of nipples, roll grooving. For installation, metalworking, industry. For job site and workshop.

Pipe threads	(¹ / ₁₆) ½–4", 16–63 mm
Bolt threads	(6) 20–60 mm, ½–2"

Thread types see page 38.

Pipe grooving with REMS roll grooving attachment	DN 25–300 1–12"
---	--------------------

**REMS Magnum – the super machine up to 4".
Exceptionally round and clean threads up to 4"
by using 6 threading dies.**

Operating principle

Rotating material - stationary tools.

Design

Robust, compact, job site-proven design. Favorable size and weight, e.g. REMS Magnum 4000 L-T only 81 kg. Large work and chip compartment. Tool support.

2 versions:

- Light version L-T with removable large oil basin and chip tray.
- Version T with integrated, even larger oil basin and chip tray.

For workbench. Stand, collapsible wheel stand or wheel stand with material shelf, as an accessory, for easy transport, optimum working height and stable positioning.

Drive

Extremely powerful and fast. Completely maintenance-free gear which runs in a sealed oil bath.

Choice of 3 powerful motors:

- Strong universal motor, 1700 W.
Overload protection. Spindle speed 23 rpm.
- Pole-reversible capacitor motor, 2100 W.
Overload protection. 2 spindle speeds 20 and 10 rpm, also under full load. **Extremely quiet running.**
- Pole-reversible 3~ induction motor, 2000 W.
Overload protection. 2 spindle speeds 20 and 10 rpm, also under full load. **Extremely quiet running.**

Operator-friendly safety foot switch with emergency-stop, 2-step. Foot switch, can be loaded with the full body weight during operation.

Chuck

Proven quick-action hammer chuck, self-tightening. No slipping of pipes. Large space between chuck and centering device ensures secure clamping of long pipes. Rear centering device for alignment of the material.

Automatic lubrication and cooling

Robust, proven oil pump with high pumping volume. Optimized oil distribution directly onto the threading point through the die head ensures clean threads and long service life of dies, gear and motor.

Universal automatic die head

Only 1 universal automatic die head each for the sizes ¹/₁₆–2" and 2½–4" for all threads, including long threads; automatic opening with automatic thread-length-stop for tapered threads. 6 dies 2½–4" ensure a favourable distribution of the cutting force onto the pipe, hence round and clean threads. Fast and easy adjustment of thread size. Simple and fast change of dies through lock-in positioning in die holder.

Dies

The proven, indestructible REMS quality dies with precise cutting geometry ensure an excellent start-cutting performance, easy threading and clean threads. Dies in a high-quality special-grade steel, fully tempered and hardened, for extremely long die life.

Pipe cutter

Self centering. Robust body made of forged steel. Ergonomic, wide handle for powerful infeed of spindle. Specially hardened cutter wheel in tough-hard REMS die-steel ensures long service life.

Inner pipe deburrer

Robust, easy-to-handle deburring device for adjustable deburring positioning. Specially hardened and designed deburring blade ensures easy deburring and extremely long service life. Two cutting edges for optimum chip flow, specially for small diameters.

Tool sets

For 2½–4" and ¼–2" one complete tool set each adapted to the work range with universal die head, pipe cutter, inner-pipe-deburring device, pressing lever, dies.



German Quality Product



Choice of 3 powerful motors.



Thread-cutting oil

REMS Sanitol and REMS Spezial (page 47). Specially developed for threading. High cooling and lubricating effect. Essential for clean threads and longer service life of dies, tools and machines.

Nipple-threading

Efficient with automatic internal clamping REMS Nippelfix ½–4" or with manual internal clamping REMS Nippelspanner ¾–2" (page 46).

REMS roll grooving attachment

Robust, compact roll grooving attachment with oil hydraulic in-feed for pipe grooving of grooved coupling systems DN 25–300, 1–12" (page 48).



Stand (Accessory)



Wheel stand (accessory)



Collapsible wheel stand (Accessory)

Supply format

REMS Magnum. Threading machine for pipe threads (1/16) ½–4", 16–63 mm, bolt threads (6) 20–60 mm, ½–2". With maintenance-free gear, safety foot switch with emergency-stop, self-tightening quick-action hammer chuck, rear centering device, automatic lubrication and cooling. With tool sets 1/16–2" and/or 2½–4", each consisting of universal automatic die head for all threads, also long threads; automatic opening, with automatic thread-length-stop for tapered threads, dies for pipe threads, tapered, ISO 7-1, EN 10226 (DIN 2999, BSPT) R right-hand, pipe cutter, inner pipe deburrer, pressing lever. Tool support. Choice of 3 motors. Version L-T with removable large oil basin and chip tray. Version T with integrated, even larger oil basin and chip tray. For workbench, stand, collapsible wheel stand or wheel stand with material shelf. In a carton.

Description	Version/Equipment	Art.-No.
4000 L-T	Universal motor 230 V or 110 V, 50–60 Hz, 1700 W. 23 rpm.	
	Equipment R ½–2	380447
	Equipment R 2½–4	380441
	Equipment R ½–4	380444
4010 L-T	Pole-reversible capacitor motor 230 V, 50 Hz, 2100 W. 20/10 rpm, also under full load. Extremely quiet running.	
	Equipment R ½–2	380448
	Equipment R 2½–4	380442
	Equipment R ½–4	380445
4020 L-T	Pole-reversible 3~ induction motor 400 V, 50 Hz, 2000 W. 20/10 rpm, also under full load. Extremely quiet running.	
	Equipment R 2½–4	380443
	Equipment R ½–4	380446
4000 T	Universal motor 230 V or 110 V, 50–60 Hz, 1700 W. 23 rpm.	
	Equipment R 2½–4	380426
	Equipment R ½–4	380429
4010 T	Pole-reversible capacitor motor 230 V, 50 Hz, 2100 W. 20/10 rpm, also under full load. Extremely quiet running.	
	Equipment R 2½–4	380427
	Equipment R ½–4	380430
4020 T	Pole-reversible 3~ induction motor 400 V, 50 Hz, 2000 W. 20/10 rpm, also under full load. Extremely quiet running.	
	Equipment R 2½–4	380428
	Equipment R ½–4	380431

Other voltages and NPT versions on request.

Accessories

Description	Art.-No.
Stand	344105
Wheel stand with material shelf	344100
Collapsible wheel stand	344150
Dies see page 38.	
Tool set 1/16–2" complete with universal automatic die head, dies for pipe threads, tapered, ISO 7-1, EN 10226 (DIN 2999, BSPT) R ½–¾ and R 1–2 right-hand, pipe cutter, inner pipe deburrer, pressing lever.	340100
Universal automatic die head 1/16–2" and others	341000
Universal automatic die head 2½–4"	381000
REMS cutter wheel St ½–4", s 8	341614
REMS cutter wheel St 1–4", s 12	381622
Thread-cutting oil see page 47.	
Nipple holder see page 46.	
REMS Herkules material supports , see page 94.	
REMS roll grooving attachment for pipe grooving, see page 48.	347000



REMS dies (set)

The proven REMS quality dies with precise cutting geometry ensure an excellent start-cutting performance, easy threading and clean threads. Dies in a high-quality special-grade steel, fully tempered and hardened, for extremely long die life.

Dies for other threads (e.g. BSW) on request. Dies in HSS for machining high strength materials 50% extra charge. ¹⁾ Some dies only available in HSS.

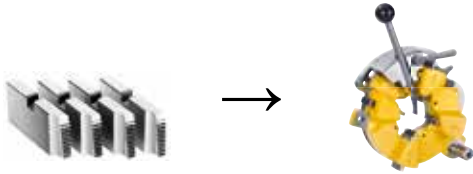

For universal automatic die head 1/16–2"

Thread type	Size	Art.-No.
Pipe threads R tapered, right-hand ISO 7-1, EN 10226 (DIN 2999, BSPT)	R 1/16–1/8 HSS ¹⁾	341401
	R 1/4–3/8	341402
	R 1/2–3/4	341403
	R 1–2	341404
Pipe threads G parallel, right-hand ISO 228-1 (DIN 259, BSPP)	G 1/16–1/8	341406
	G 1/4–3/8	341407
	G 1/2–3/4	341408
	G 1–2	341409
Pipe threads NPT tapered, right-hand Taper Pipe Thread ASME B1.20.1	NPT 1/16–1/8 HSS ¹⁾	341411
	NPT 1/4–3/8	341412
	NPT 1/2–3/4	341413
	NPT 1–2	341414
Pipe threads NPSM parallel, right-hand Straight Pipe Thread ASME B1.20.1	NPSM 1/8	341416
	NPSM 1/4–3/8	341417
	NPSM 1/2–3/4	341418
	NPSM 1–2 HSS ¹⁾	341419
Conduit threads Pg DIN 40430	Pg 7	341466
	Pg 9	341467
	Pg 11	341468
	Pg 13,5	341469
	Pg 16	341470
	Pg 21	341471
	Pg 29	341472
	Pg 36	341473
	Pg 42	341474
	Pg 48	341475
	Conduit threads M EN 60423	M 16 × 1,5
M 20 × 1,5		341494
M 25 × 1,5		341495
M 32 × 1,5		341496
M 40 × 1,5		341497
M 50 × 1,5		341498
M 63 × 1,5		341499
Metric bolt threads M ISO 261 (DIN 13)		M 6
	M 8	341427
	M 10	341428
	M 12	341429
	M 14	341430
	M 16	341431
	M 18	341432
	M 20	341433
	M 22	341434
	M 24	341435
	M 27	341436
	M 30	341437
	M 33	341438
	M 36	341439
	M 39	341440
	M 42	341441
	M 45	341442
	M 48	341443
	M 52	341444
	M 56 HSS ¹⁾	341445
M 60 HSS ¹⁾	341446	
Bolt threads UNC Unified Inch Screw Thread ASME B1.1	UNC 1/4–20	341476
	UNC 5/16–18	341477
	UNC 3/8–16 HSS ¹⁾	341478
	UNC 7/16–14	341479
	UNC 1/2–13 HSS ¹⁾	341480
	UNC 9/16–12	341481
	UNC 5/8–11 HSS ¹⁾	341482
	UNC 3/4–10 HSS ¹⁾	341483
	UNC 7/8–9 HSS ¹⁾	341484
	UNC 1–8 HSS ¹⁾	341485
	UNC 1 1/8–7	341486
	UNC 1 1/4–7 HSS ¹⁾	341487
	UNC 1 3/8–6	341488
	UNC 1 1/2–6 HSS ¹⁾	341489
	UNC 1 3/4–5	341490
UNC 2–4,5	341491	

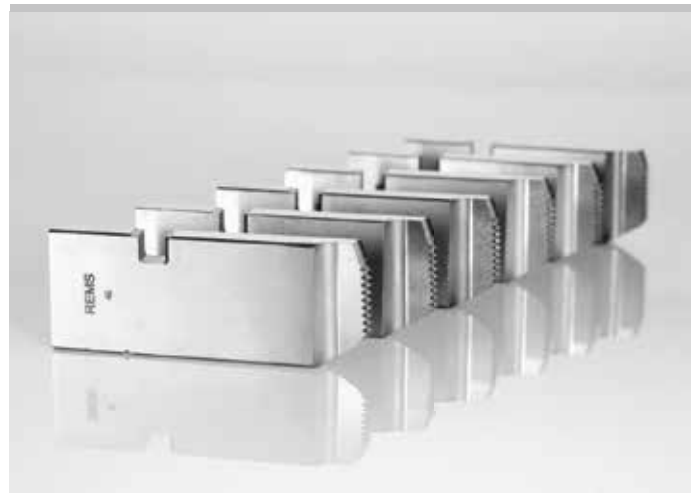

German Quality Product

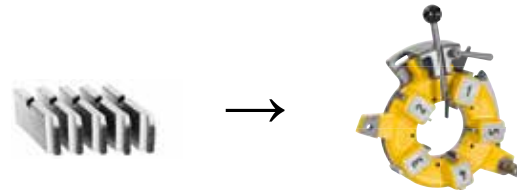

For universal automatic die head 2 1/2–3"

Thread type	Size	Art.-No.
Pipe threads R tapered, right-hand ISO 7-1, EN 10226 (DIN 2999, BSPT)	R 2 1/2–3	381430
Pipe threads G parallel, right-hand ISO 228-1 (DIN 259, BSPP)	G 2 1/2–3 HSS ¹⁾	381431
Pipe threads NPT tapered, right-hand Taper Pipe Thread ASME B1.20.1	NPT 2 1/2–3 HSS ¹⁾	381432
Pipe threads NPSM parallel, right-hand Straight Pipe Thread ASME B1.20.1	NPSM 2 1/2–3 HSS ¹⁾	381433

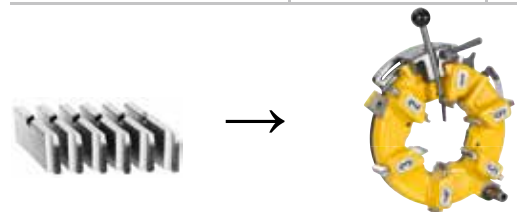

For universal automatic die head 2 1/2–4"

Thread type	Size	Art.-No.
Pipe threads R tapered, right-hand ISO 7-1, EN 10226 (DIN 2999, BSPT)	R 2 1/2–4	381401
Pipe threads G parallel, right-hand ISO 228-1 (DIN 259, BSPP)	G 2 1/2–4 HSS ¹⁾	381405
Pipe threads NPT tapered, right-hand Taper Pipe Thread ASME B1.20.1	NPT 2 1/2–4 HSS ¹⁾	381410
Pipe threads NPSM parallel, right-hand Straight Pipe Thread ASME B1.20.1	NPSM 2 1/2–4 HSS ¹⁾	381415

REMS 4" automatic die head

Threading attachment

Robust, compact threading attachment for efficient threading of tapered pipe threads, nipple-threading.

Pipe threads 2½–4"

REMS 4" automatic die head – excellent threads up to 4" thanks to 5 threading dies and stepless automatically opening die head. No time consuming reverse.

Operating principle

Stationary material – rotating die head.

Design

Compact unit of die head, clamping chuck and gear. Maintenance-free. Easy to transport.

Technique and operation

- Secure grip, self-tightening chuck, no slipping of pipe.
- Easy start-cutting with pressing lever and rack.
- 5 dies per size ensure favourable distribution of cutting force onto the pipe for round and clean threads.
- During threading the die head opens tapered in a gradual manner (copying unit), which enables a high cutting speed with low power requirements. Provides perfect threads as well as low impact on dies and machines.
- Automatic die head opening after reaching the standard thread length.
- After threading, immediate re-use possible, no guide thread required, no time-consuming reverse.
- Connection for automatic lubrication and cooling.

Dies

The proven, indestructible REMS quality dies with precise cutting geometry ensure an excellent start-cutting performance, easy threading and clean threads. Dies in a high-quality special-grade steel, fully tempered and hardened, for extremely long die life.

Drive

Through REMS Magnum, REMS Tornado, REMS Amigo 2 and threading machines of other makes. Fast, simple assembly. Rugged drive shaft for secure clamping and optimum power transmission.

Thread-cutting oil

REMS Sanitol and REMS Spezial (page 47). Specially developed for threading. High cooling and lubricating effect. Essential for clean threads and longer service life of dies, tools and machines.

Nipple-threading

Efficient nipple threading 2½–4" with the automatic internal clamping REMS Nippelfix (page 46).



German Quality Product

Supply format

REMS 4" automatic die head. Threading device for pipe threads 2½–4". Die head with copying unit, automatic opening after reaching the standard thread length, no time-consuming reverse. Self-tightening clamping device. Reduction gear with drive shaft, maintenance-free. Connection for automatic cooling and lubrication. Chip tray. Dies optional for pipe threads, tapered, ISO 7-1, EN 10226 (DIN 2999, BSPT) R 2½, 3, 4, right-hand or for pipe threads, tapered, NPT 2½, 3, 4, right-hand. In a carton.

Description	Equipment	Art.-No.
REMS 4" automatic die head fits to REMS Magnum, REMS Tornado, and others	R 2½, 3, 4	370010
REMS 4" automatic die head fits to REMS Magnum, REMS Tornado, and others	NPT 2½, 3, 4	370011
REMS 4" automatic die head fits to REMS Amigo 2	R 2½, 3, 4	370012
REMS 4" automatic die head fits to REMS Amigo 2	NPT 2½, 3, 4	370013

Accessories

Description	Size	Art.-No.
Dies (set)		
Pipe threads R tapered right-hand ISO 7-1, EN 10226 (DIN 2999, BSPT)	R 2½ R 3 R 4	371109 371113 371117
Pipe threads NPT tapered right-hand Taper Pipe Thread ASME B1. 20.1	NPT 2½ HSS ¹⁾ NPT 3 HSS ¹⁾ NPT 4 HSS ¹⁾	371134 371138 371142

Dies in HSS for machining high strength materials 50% extra charge. ¹⁾ Some dies only available in HSS.

REMS Herkules, material supports, see page 94.

Thread-cutting oil see page 47.

Nippelfix 2½–4" see page 46.



REMS Unimat 75

Threading machine

Semi-automatic high-performance machine for efficient cutting of bolt and pipe threads. For industry, metalworking, installation.

Bolt threads	6–72 mm 1/4–2 3/4"	
Pipe threads	1/16–2 1/2", 16–63 mm	
Tolerance class corresponding to ISO 261 (DIN 13)	"medium" (6 g)	
Thread length	≤ Ø 30 mm	unlimited
	≤ Ø 72 mm	≤ 200 mm
Chamfering	Range	7–62 mm
	Chamfered Ø	≥ 7 mm
	Maximum chamfer	7 mm
	Chamfer angle	45°
Peeling	Range	7–62 mm
	Peeled Ø	≥ 7 mm
Thread types see page 42.		



German Quality Product

REMS Unimat 75 – high efficiency. Tangential-chaser-threading-system. Large threading range. Fast working, short resetting time. For single and series production. Low hourly rate for the machine. Simple operation. Relieves expensive turning machines and specialists.

Operating principle

Stationary material – rotating die head.

Design

Compact, rugged design for continuous use. Die head with regrindable tangential chasers in self centering holder system. After start-cutting with feed lever and rack mechanism self feeding action of die head (no guide thread). Welded, sturdy machine stand with large oil compartment and removeable chip drawer.

Drive

Indestructible planetary gear with annulus gear for long threads up to Ø 30 mm. Proven and powerful pole-reversible three-phase motor, specially designed for threading, with hollow shaft, 2000/2300 W. Overload protection. Reverse switch for cutting right and left-hand threads. High operating speed, 2 spindle speeds 70 and 35 rpm.

Clamping device

Self-centering universal vice for the complete range with specially toothed and hardened clamping jaws. Choice of manual or hydraulic clamping with operation by foot switch (working pressure 6 bar).

Special clamping jaws

For drawn material, stud bolts, hex screws and pipe nipples, as accessory.

Automatic lubrication and cooling

Robust, proven oil pump with high pumping volume. Ample oil volume ensures longer service life of chasers, gear and motor.

Universal automatic die head

Only **one** universal automatic die head for all threads. Fine adjustment of thread diameter with spindle and scale. Die head closes automatically and opens automatically when the required thread length is reached. After starting the thread via feed lever and rack the chaser-system initiates an automatic feed-forward of the die head. All threads can be cut in a single pass. Copying unit for tapered threads. Instead of changing the dies, additional quick-change die heads ensure shorter resetting time.

Chasers

The proven regrindable REMS tangential chasers with precise cutting geometry ensure an excellent start-cutting performance and clean threads. Tool steel chasers made of special hardened steel for material up to 500 N/mm². HSS chasers for hard-to-machine material above 500 N/mm². The chasers sit in a special holder system. Chasers and holders together form a threading set.

Thread cutting on rebar

Special chaser dies M with additional, ground cut for cutting threads on rebar in a single pass. Driven by REMS Unimat 75 with oil-hydraulic/pneumatic vice, for high clamping pressure.

Machining examples



Thread-cutting oil

REMS Sanitol and REMS Spezial (page 47). Specially developed for threading. High cooling and lubricating effect. Essential for clean threads and longer service life of dies, tools and machines.

Nipple-threading

Efficient with special clamping jaws $1/16$ – $1/4$ " or with the automatic internal clamping REMS Nippelfix $1/2$ – $2 1/2$ " or with the manual internal clamping REMS Nippelspanner $3/8$ – 2 " (page 46).



Supply format

REMS Unimat 75 Basic. Semi-automatic threading machine for bolt threads 6–72 mm, $1/4$ – $2 3/4$ ", pipe threads $1/16$ – $2 1/2$ ", 16–63 mm. Machine on stand. Pole-reversible 3~ induction motor with hollow shaft, 400 V, 50 Hz, 2000/2300 W, right and left-hand rotation. Die head speed 70 and 35 rpm. Self-centering universal chuck for the complete clamping range, choice of manual or oil-hydraulic/pneumatic operation. Automatic lubrication and cooling. 1 universal automatic die head for all threads, opens and closes automatically. Without threading sets, without closing lever. Electric locking system of safety cover. Adjustment gauge. Wrench. In transport case.

Description	Version	Art.-No.
REMS Unimat 75 Basic mS	manual clamping device	750003
REMS Unimat 75 Basic pS	oil-hydraulic/pneumatic vice clamping device	750004

Other voltages on request.

Accessories

Description	Art.-No.
Chasers and holders (threading sets) and chasers see page 42.	
Universal automatic die head , without threading sets, without closing lever	751000
Closing lever for closing and opening the chasers	
R for taper pipe threads, right-hand	751040
R-L for taper pipe threads, left-hand	751050
G for cylindrical pipe threads, right-hand	751060
G-L for cylindrical pipe threads, left-hand	751070
M for all bolt threads, right-hand	751080
M-L for all bolt threads, left-hand	751090
Chamfering/peeling die head 45°, Ø 7 – 62 mm , with chamfering/peeling chasers 45°, Ø 7 – 62 mm, HSS, with holder	751100
Chamfering/peeling die head 45°, Ø 7 – 62 mm , without threading sets	751102
Chamfering/peeling chasers 45°, Ø 7 – 46 mm , HSS, with holder	751096
Chamfering/peeling chasers 45°, Ø 40 – 62 mm , HSS, with holder	751098
Chamfering/peeling chasers 45°, Ø 7 – 62 mm , pack of 4, with holder	751097
Special clamping jaws, pair , for drawn material, stud bolts and hex screws. Workpiece length protrude from vice without thread, minimum 15 mm, Ø 6 – 42 mm	753240
Thread-cutting oil see page 47.	
Nipple holder see page 46.	
REMS Herkules material supports , see page 94.	





German Quality Product

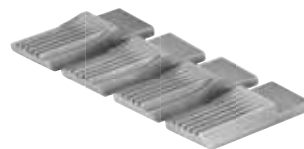

German Quality Product

Chasers and holders (threading set)

The proven regrindable REMS tangential chasers with precise cutting geometry ensure an excellent start-cutting performance and clean threads. Tool steel chasers made of special hardened steel for material up to 500 N/mm². HSS chasers for hard-to-machine material above 500 N/mm². The chasers sit in a special holder system. Chasers and holders together form a threading set.

Thread type	Size	Art.-No.
Pipe threads R tapered, right-hand ISO 7-1, EN 10226 (DIN 2999, BSPT)	R 1/16-1/8	759250
	R 1/4-3/8	759251
	R 1/2-3/4	759252
	R 1-2	759253
	R 2 1/2	759254
Pipe threads G parallel, right-hand ISO 228-1 (DIN 259, BSPP)	G 1/16-1/8	759255
	G 1/4-3/8	759256
	G 1/2-3/4 HSS ¹⁾	759257
	G 1-2 HSS ¹⁾	759258
	G 2 1/2 HSS ¹⁾	759259
Pipe threads NPT tapered, right-hand Taper Pipe Thread ASME B1. 20.1	NPT 1/16-1/8	759360
	NPT 1/4-3/8	759361
	NPT 1/2-3/4 HSS ¹⁾	759362
	NPT 1-2 HSS ¹⁾	759363
Pipe threads NPSM parallel, right-hand Straight Pipe Thread ASME B1. 20.1	NPSM 1/16-1/8	759365
	NPSM 1/4-3/8	759366
	NPSM 1/2-3/4 HSS ¹⁾	759367
	NPSM 1-2 HSS ¹⁾	759368
Conduit threads Pg DIN 40430	Pg 7	759260
	Pg 9-16	759261
	Pg 21-48	759262
	Conduit threads M EN 60423	M 16-20 x 1,5
M 25-32 x 1,5		759264
M 40-50 x 1,5		759265
M 63 x 1,5 HSS ¹⁾		759330
Threads M for rebar ISO 261 (DIN 13)		M 14-16 HSS
	M 18-22 HSS	759275
	M 24-27 HSS	759276
	M 30-33 HSS	759277
	M 36-39 HSS	759278
	M 42-45 HSS	759279
	Metric bolt threads M ISO 261 (DIN 13)	M 6
M 8		759271
M 10		759272
M 12		759273
M 14-16		759274
M 18-22		759275
M 24-27		759276
M 30-33		759277
M 36-39		759278
M 42-45		759279
M 48-52		759280
M 56-60 HSS ¹⁾		759281
M 64-72		759282
Bolt threads UNC Unified Inch Screw Thread ASME B1.1	UNC 1/4-20	759370
	UNC 5/16-18	759371
	UNC 3/8-16	759372
	UNC 7/16-14	759373
	UNC 1/2-13	759374
	UNC 9/16-12	759375
	UNC 5/8-11	759376
	UNC 3/4-10	759377
	UNC 7/8-9	759378
	UNC 1-8 HSS ¹⁾	759379
	UNC 1 1/8-1 1/4-7	759380
	UNC 1 3/8-1 1/2-6	759381
	UNC 1 5/8-5	759382
	UNC 2-2 1/4-4,5	759383
	UNC 2 1/2-2 3/4-4	759384

Die sets for other threads (e.g. bicycle screw thread, fine thread, BSW) and die sets with chaser dies made of high-speed steel (HSS) for processing high-strength materials on request. 50% surcharge on chaser dies for HSS.
¹⁾ Some chasers only available in HSS. Threading sets for left-hand threads 50% extra charge on chasers.

Chasers (set)

The proven regrindable REMS tangential chasers with precise cutting geometry ensure an excellent start-cutting performance and clean threads. Tool steel chasers made of special hardened steel for material up to 500 N/mm². HSS chasers for hard-to-machine material above 500 N/mm².

Thread type	Size	Art.-No.
Pipe threads R tapered, right-hand ISO 7-1, EN 10226 (DIN 2999, BSPT)	R 1/16-1/8	751501
	R 1/4-3/8	751502
	R 1/2-3/4	751503
	R 1-2 1/2	751504
Pipe threads G parallel, right-hand ISO 228-1 (DIN 259, BSPP)	G 1/16-1/8	751505
	G 1/4-3/8	751506
	G 1/2-3/4 HSS ¹⁾	751507
	G 1-2 1/2 HSS ¹⁾	751508
Pipe threads NPT tapered, right-hand Taper Pipe Thread ASME B1. 20.1	NPT 1/16-1/8	751544
	NPT 1/4-3/8	751545
	NPT 1/2-3/4 HSS ¹⁾	751546
	NPT 1-2 HSS ¹⁾	751547
Pipe threads NPSM parallel, right-hand Straight Pipe Thread ASME B1. 20.1	NPSM 1/16-1/8	751549
	NPSM 1/4-3/8	751550
	NPSM 1/2-3/4 HSS ¹⁾	751551
	NPSM 1-2	751552
Conduit threads Pg DIN 40430	Pg 7	751509
	Pg 9-16	751510
	Pg 21-48	751511
Conduit threads M EN 60423	M 16-63 x 1,5 (M 10)	751518
Threads M for rebar ISO 261 (DIN 13)	M 14-16 HSS	751520
	M 18-22 HSS	751521
	M 24-27 HSS	751522
	M 30-33 HSS	751523
	M 36-39 HSS	751524
	M 42-45 HSS	751525
	Metric bolt threads M ISO 261 (DIN 13)	M 6
M 8		751517
M 10 (M 16-63 x 1,5)		751518
M 12		751519
M 14-16		751520
M 18-22		751521
M 24-27		751522
M 30-33		751523
M 36-39		751524
M 42-45		751525
M 48-52		751526
M 56-60		751527
M 64-72		751528
Bolt threads UNC Unified Inch Screw Thread ASME B1.1	UNC 1/4-20	751557
	UNC 5/16-18	751558
	UNC 3/8-16	751559
	UNC 7/16-14	751560
	UNC 1/2-13	751561
	UNC 9/16-12	751562
	UNC 5/8-11	751563
	UNC 3/4-10	751564
	UNC 7/8-9	751565
	UNC 1-8 HSS ¹⁾	751566
	UNC 1 1/8-1 1/4-7	751567
	UNC 1 3/8-1 1/2-6	751568
UNC 1 5/8-5	751569	
UNC 2-2 1/4-4,5	751570	
UNC 2 1/2-2 3/4-4	751571	

Chaser dies for other threads (e.g. bicycle screw thread, fine thread, BSW) and chaser dies made of high-speed steel (HSS) for processing high-strength materials on request. 50% surcharge for HSS. ¹⁾ Some chasers only available in HSS. Chasers for left-hand threads 50% extra charge.

Thread tables

Taper Pipe Threads

Whitworth Pipe Thread ISO 7-1, EN 10226 (DIN 2999, BSPT) External thread taper 1:16 Flank angle 55°		
Nominal Size R BSPT	Outside Ø of thread mm	T.P.I.
1/16	7.723	28
1/8	9.728	28
1/4	13.157	19
3/8	16.662	19
1/2	20.955	14
3/4	26.441	14
1	33.249	11
1 1/4	41.910	11
1 1/2	47.803	11
2	59.614	11
2 1/2	75.184	11
3	87.884	11
4	113.030	11

Standard Taper Pipe Thread NPT, ASME B 1.20.1 External thread taper 1:16 Flank angle 60°		
Nominal Size NPT	Outside Ø of thread mm	T.P.I.
1/16	7.938	27
1/8	10.287	27
1/4	13.716	18
3/8	17.145	18
1/2	21.336	14
3/4	26.670	14
1	33.401	11.5
1 1/4	42.164	11.5
1 1/2	48.260	11.5
2	60.325	11.5
2 1/2	73.025	8
3	88.900	8
3 1/2	101.600	8
4	114.300	8

Whitworth Pipe Thread ISO 228-1 (DIN 259, BSPP) External thread parallel Flank angle 55°		
Nominal Size G BSPP	Outside Ø of thread mm	T.P.I.
1/16	7.723	28
1/8	9.728	28
1/4	13.157	19
3/8	16.662	19
1/2	20.955	14
3/4	26.441	14
1	33.249	11
1 1/4	41.910	11
1 1/2	47.803	11
2	59.614	11
2 1/2	75.184	11
3	87.884	11
3 1/2	100.330	11
4	113.030	11

Straight Pipe Thread for Fixtures NPSM, ASME B 1.20.1 External thread parallel Flank angle 60°		
Nominal Size NPSM	Outside Ø of thread mm	T.P.I.
1/8	10.083	27
1/4	13.360	18
3/8	16.815	18
1/2	20.904	14
3/4	26.264	14
1	32.842	11.5
1 1/4	41.605	11.5
1 1/2	47.676	11.5
2	59.715	11.5
2 1/2	72.161	8
3	88.062	8
3 1/2	100.787	8
4	113.436	8

Metric Bolt Thread

Metric ISO Thread ISO 261 (DIN 13) External thread Flank angle 60°		
Nominal Size M	Outside Ø of thread mm	Pitch mm
6	5.974	1
8	7.972	1.25
10	9.968	1.5
12	11.966	1.75
14	13.962	2
16	15.962	2
18	17.958	2.5
20	19.958	2.5
22	21.958	2.5
24	23.952	3
27	26.952	3
30	29.947	3.5
33	32.947	3.5
36	35.940	4
39	38.940	4
42	41.937	4.5
45	44.937	4.5
48	47.929	5
52	51.929	5
56	55.925	5.5
60	59.925	5.5
64	63.920	6
68	67.920	6
72	71.920	6

American and British Bolt Threads

Unified Inch Screw Thread UNC, ASME B 1.1 External thread Flank angle 60°		
Nominal Size UNC	Outside Ø of thread mm	T.P.I.
1/4	6.322	20
5/16	7.907	18
3/8	9.491	16
7/16	11.076	14
1/2	12.661	13
9/16	14.246	12
5/8	15.834	11
3/4	19.004	10
7/8	22.176	9
1	25.349	8
1 1/8	28.519	7
1 1/4	31.694	7
1 3/8	34.864	6
1 1/2	38.039	6
1 3/4	44.381	5
2	50.726	4.5
2 1/4	57.076	4.5
2 1/2	63.421	4
2 3/4	69.768	4

British Standard Parallel Screw Thread of Whitworth Form B.S.W. BS 84 (obsolete): External thread Flank angle 55°		
Nominal Size BSW	Outside Ø of thread mm	T.P.I.
1/4	6.350	20
5/16	7.937	18
3/8	9.525	16
7/16	11.112	14
1/2	12.700	12
5/8	15.875	11
3/4	19.050	10
7/8	22.225	9
1	25.400	8
1 1/8	28.575	7
1 1/4	31.750	7
1 1/2	38.100	6
1 3/4	44.450	5
2	50.800	4.5
2 1/4	57.150	4
2 1/2	63.500	4
2 3/4	69.850	3.5

Threads for Electric Conduit

Conduit Thread DIN 40 430 External thread parallel Flank angle 80°		
Nominal Size Pg	Outside Ø of thread mm	T.P.I.
7	12.5	20
9	15.2	18
11	18.6	18
13.5	20.4	18
16	22.5	18
21	28.3	16
29	37	16
36	47	16
42	54	16
48	59.3	16

Conduit Thread EN 60423 External thread parallel Flank angle 60°		
Nominal Size M	Outside Ø of thread mm	T.P.I.
6	15.968	1.5
20	19.968	1.5
25	24.968	1.5
32	31.968	1.5
40	39.968	1.5
50	49.968	1.5
63	62.968	1.5

Outside diameter of thread is always the maximum diameter, for taper pipe threads this is measured at the scale line.

Semi-automatic high-performance machine for efficient cutting of pipe threads. For industry, metalworking, installation.

Pipe threads	1/4–4"
Thread length	≤ 120 mm

REMS Unimat 77 – pipe threads up to 4".

Tangential-chaser-threading-system.

Fast working, short resetting time.

For single and series production.

Operating principle

Stationary material – rotating die head.

Design

Compact, rugged design for continuous use. Die head with regrindable tangential chasers in self centering holder system. After start-cutting with feed lever and rack mechanism self feeding action of die head (no guide thread). Welded, sturdy machine stand with large oil compartment and removeable chip drawer.

Drive

Robust worm gear and 2-stage spur gear. Proven and powerful pole-reversible three-phase motor, specially designed for threading, 2000/2300 W. Overload protection. Reverse switch for cutting right and left-hand threads. 4 spindle speeds 50, 25, 16, 8 rpm.

Clamping device

Self-centering universal vice for the complete range with specially toothed and hardened clamping jaws (1/4–3/4", 1–4"). Choice of manual or hydraulic clamping with operation by foot switch (working pressure 6 bar).

Automatic lubrication and cooling

Robust, proven oil pump with high pumping volume. Ample oil volume ensures longer life of chasers, gear and motor.

Universal automatic die head

Only **one** universal automatic die head for all threads. Fine adjustment of thread diameter with spindle and scale. Die head closes automatically and opens automatically when the required thread length is reached. After starting the thread via feed lever and rack the chaser-system initiates an automatic feed-forward of the die head. All threads can be cut in a single pass. Copying unit for tapered threads. Instead of changing the dies, additional quick-change die heads ensure shorter resetting time.

Chasers

The proven regrindable REMS tangential chasers with precise cutting geometry ensure an excellent start-cutting performance and clean threads. Tool steel chasers made of special hardened steel for material up to 500 N/mm². HSS chasers for hard-to-machine material above 500 N/mm². The chasers sit in a special holder system. Chasers and holders together form a threading set.

Thread-cutting oil

REMS Sanitol and REMS Spezial (page 47). Specially developed for threading. High cooling and lubricating effect. Essential for clean threads and longer service life of dies, tools and machines.

Nipple-threading

Efficient with the automatic internal clamping REMS Nippelfix 1/2–4" or with the manual internal clamping REMS Nippelspanner 3/8–2" (page 46).



German Quality Product

Machining examples





Supply format

REMS Unimat 77 Basic. Semi-automatic threading machine for pipe threads 1/4–4". Machine on stand. Pole-reversible 3~ induction motor, 400 V, 50 Hz, 2000/2300 W, right and left-hand rotation. Die head speed 50, 25, 16, 8 rpm. Universal vice with clamping jaws 1–4", choice of manual or hydraulic/pneumatic operation. Automatic lubrication. 1 universal automatic die head for all threads, opens and closes automatically. Without threading sets, without closing lever. Electrical locking system of safety cover. Adjustment gauge. Wrench. In transport case.

Description	Version	Art.-No.
REMS Unimat 77 Basic mS	manual clamping device	770003
REMS Unimat 77 Basic pS	Oil-hydraulic/pneumatic vice clamping device	770004

Other voltages on request.

Accessories

Chasers and holders (threading set)

Thread type	Size	Art.-No.
Pipe threads R tapered, right-hand ISO 7-1 (EN 10226, DIN 2999, BSPT)	R 1/4–3/8	771110
	R 1/2–3/4	771120
	R 1–2	771130
	R 2 1/2–4	771140
Pipe threads G parallel, right-hand ISO 228-1 (DIN 259, BSPP)	G 1/4–3/8	771160
	G 1/2–3/4 HSS ¹⁾	771170
	G 1–2 HSS ¹⁾	771180
	G 2 1/2–4 HSS ¹⁾	771190
Pipe threads NPT tapered, right-hand Taper Pipe Thread ASME B1.20.1	NPT 1/4–3/8	771210
	NPT 1/2–3/4 HSS ¹⁾	771220
	NPT 1–2 HSS ¹⁾	771230
	NPT 2 1/2–4 HSS ¹⁾	771240
Pipe threads NPSM parallel, right-hand Straight Pipe Thread ASME B1.20.1	NPSM 1/4–3/8	771260
	NPSM 1/2–3/4 HSS ¹⁾	771270
	NPSM 1–2	771280
	NPSM 2 1/2–4	771290



Chasers (set)

Thread type	Size	Art.-No.
Pipe threads R tapered, right-hand ISO 7-1 (EN 10226, DIN 2999, BSPT)	R 1/4–3/8	751502
	R 1/2–3/4	751503
	R 1–4	771136
Pipe threads G parallel, right-hand ISO 228-1 (DIN 259, BSPP)	G 1/4–3/8	751506
	G 1/2–3/4 HSS ¹⁾	751507
	G 1–4 HSS ¹⁾	771186
Pipe threads NPT tapered, right-hand Taper Pipe Thread ASME B1.20.1	NPT 1/4–3/8	751545
	NPT 1/2–3/4 HSS ¹⁾	751546
	NPT 1–2 HSS ¹⁾	751547
	NPT 2 1/2–4 HSS ¹⁾	771246
Pipe threads NPSM parallel, right-hand Straight Pipe Thread ASME B1.20.1	NPSM 1/4–3/8	751550
	NPSM 1/2–3/4 HSS ¹⁾	751551
	NPSM 1–2	751552
	NPSM 2 1/2–4	771296

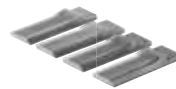

Die sets and chaser dies for other threads and die sets and chaser dies made of high-speed steel (HSS) for processing high-strength materials on request. 50% surcharge on chaser dies for HSS. ¹⁾ Some threading sets and chasers only available in HSS. Threading sets and chasers for left-hand threads 50% extra charge.

Description	Art.-No.
Universal automatic die head, without threading sets, without closing lever	771000
Closing lever for closing and opening the chasers	
R for taper pipe threads, right-hand	751040
R-L for taper pipe threads, left-hand	751050
G for cylindrical pipe threads, right-hand	751060
G-L for cylindrical pipe threads, left-hand	751070
Clamping jaws 1/4–3/4" (pack of 2)	773060
Thread-cutting oil see page 47.	
Nipple holder see page 46.	
REMS Herkules material supports, see page 94.	



REMS Nippelspanner

Accessories for threading machines and hand die stocks of all types and makes

Manual pipe nipple chuck for internal clamping of short pipe pieces. For universal use.

Nipples and double nipples in standard and special lengths 3/8–2"

REMS Nippelspanner – efficient nipple-threading. Any length. Anywhere.

To be used universally for threading machines and for hand die stocks of all types and makes. For opening and non-opening die heads. Ideal accessory for REMS Amigo E, REMS Amigo, REMS Amigo 2 and REMS eva and other makes.

Ideal tool for using up short pipe pieces. Saves time and money.

Chucking and centering of pipe pieces by expanding of specially hardened spring steel segments.

Internal clamping, so no thread required for clamping.

Supply format

REMS Nippelspanner. Manual pipe nipple chuck for internal clamping of short pipe pieces.

Description	Size	Art.-No.
REMS Nippelspanner	3/8"	110000
	1/2"	110100
	3/4"	110200
	1"	110300
	1 1/4"	110400
	1 1/2"	110500
	2"	110600

Supply format

REMS Nippelspanner Set. Manual pipe nipple chuck for internal clamping of short pieces of pipe. In sturdy steel case.

Description	Art.-No.
Set 1/2-3/4-1-1 1/4"	110620
Set 1/2-3/4-1-1 1/4-1 1/2-2"	110621

REMS Nippelfix

Automatic pipe nipple chuck for internal clamping of short pipe pieces.

Nipples and double nipples in standard and special lengths 1/2–4"

REMS Nippelfix – efficient nipple-threading up to 4". Any length. Anywhere. Automatic internal clamping. Super fast and simple.

For threading machines with opening die head: Pipe turning machines, machines with rotating die head, threading devices.

Ideal tool for using up short pipe pieces. Saves time and money.

Automatic quick-chuck and centering of pipe piece. No tools.

Automatic release after completion of nipple. Production of nipples possible without taking the Nippelfix out of the clamping device.

Internal clamping, so no thread required for clamping.

Specially hardened and ground clamping jaws for fast and safe clamping.

Supply format

REMS Nippelfix. Automatic pipe nipple chuck for internal clamping of short pipe pieces.

Description	Size	Art.-No.
REMS Nippelfix	1/2"	111000
	3/4"	111100
	1"	111200
	1 1/4"	111300
	1 1/2"	111400
	2"	111500
	2 1/4"	111700
	3"	111800
	4"	111900

Supply format

REMS Nippelfix Set. Automatic pipe nipple chuck for internal clamping of short pieces of pipe. In sturdy steel case.

Description	Art.-No.
Set 1/2-3/4-1-1 1/4"	111620
Set 1/2-3/4-1-1 1/4-1 1/2-2"	111621



German Quality Product



Accessories for threading machines with opening die head



German Quality Product



REMS Spezial

Thread-cutting oil

High-alloyed mineral oil based thread-cutting oil. For all materials: steel, stainless steel, non-ferrous metal, plastic.

For drinking water supplies, comply with local regulations! In AUT, CHE, DEU, DNK not permitted for drinking water supplies.

REMS Spezial – high-alloyed mineral based thread-cutting oil, can be washed out with water. High lubricating and cooling effect.

Specially developed for threading. High lubricating and cooling effect. Essential for clean threads, long service life of dies, tools and machines. Pleasant to work with. Can be washed out with water, approved by experts. Also well suited as a cooling lubricant for sawing metals. REMS Spezial spray without CFC's, so ozone-harmless. REMS Spezial squirt bottle without propellants. Refillable.



German Quality Product

Supply format

REMS Spezial. High-alloyed mineral based thread-cutting oil.

Description	Packing	Art.-No.
REMS Spezial	5l can	140100
	10l can	140101
	50l barrel	140103
	600ml spray	140105
	500ml squirt bottle	140106

REMS Sanitol

Thread-cutting oil

Synthetic, mineral oil free thread-cutting oil. Specially for drinking water supplies. Also for universal use. For all materials.

REMS Sanitol – mineral oil free. Completely water soluble. High lubricating and cooling effect.

Completely water soluble. Complies with the DVGW, ÖVGW, SVGW regulations. Viscosity at -10°C: 219 mPa s (cP). Pumpable to -28°C. Simple to work with. Red in colour for flushing control. Perfect corrosion protector. Developed especially for drinking water pipes but also excellently suitable for universal thread cutting. High lubricating and cooling effect. Essential for clean threads, long service life of dies, tools and machines. Also well suited as a cooling lubricant for sawing metals. REMS Sanitol spray without CFC's, so ozone-harmless. REMS Sanitol squirt bottle without propellants. Refillable.



German Quality Product

Supply format

REMS Sanitol. Synthetic, mineral oil free thread-cutting oil specially for drinking water supplies and for universal use.

Description	Packing	Art.-No.
REMS Sanitol	5l can	140110
	50l barrel	140113
	600ml spray	140115
	500ml squirt bottle	140116



DW-0201 AS2032



W1.303



7808-649

REMS roll grooving attachment

Roll grooving attachment

Robust, compact roll grooving attachment with oil hydraulic forward feed for grooving pipes of pipe coupling systems. For installation, sprinkler lines, commercial heating, industry and mining. For job site and workshop.

Steel pipes DN 25–300
1–12"
s ≤ 7.2 mm

Stainless steel pipes, copper, aluminium, PVC pipes

REMS roll grooving attachment – compact – universal. Oil hydraulic pressure cylinder for powerful in-feed of pressure roller.

Design

Compact, job site-proven. Robust metal housing for tough use. Handy, easy to transport, only 26 kg. Oil hydraulic pressure cylinder for powerful in-feed of pressure roller. Pressure build-up with hydraulic hand pump. Individually adjustable groove-depth-stop with fine adjustment, for automatic limitation of groove depth. Built-in ring gauge for automatic groove-depth-stop.

Grooving rollers

The proven REMS grooving rollers with perfectly size-adjusted pressure rollers and counterpressure rollers with well gripping axial knurls guarantee a secure rotation of the pipe and precise grooving. Grooving rollers machined from hardened special steel ensure extremely long service life. 3 pairs of groove rollers (pressure roller, counter-pressure roller) for the whole working range DN 25–300, 1–12", easy change. Grooving rollers Cu (pressure roller, counterpressure roller) for copper pipe 54–159 mm. Groove rollers INOX (pressure roller made of stainless steel, counter-pressure roller made of toughened, specially hardened steel, nickel-plated) for stainless steel pipes 2–6" and 8–12". Grooving rollers for aluminium, PVC pipes on request.

Drive

Only one roll grooving device for REMS Amigo, REMS Amigo 2, REMS Amigo 2 Compact, REMS Tornado and REMS Magnum. Fast, simple assembly. 3-face drive shaft of roll grooving attachment for secure clamping and optimum power transmission. Roll grooving attachments for threading machines of other makes, adjusted to support arm distance, diameter of support arm and spindle axis of the corresponding drive machine, on request.



German Quality Product



Supply format

REMS roll grooving attachment. Roll grooving attachment for grooving pipes of pipe coupling systems DN 25–300, 1–12". Roll grooving attachment, hydraulic hand pump, built-in ring gauge for automatic groove-depth-stop, 1 pair of groove rollers (pressure roller, counter-pressure roller) 2–6", Allen key. For REMS Amigo, REMS Amigo 2, REMS Amigo 2 Compact, REMS Tornado and REMS Magnum or for other thread cutting machine makes. In a carton.

Description	fit onto	Art.-No.
REMS roll grooving attachment	REMS Amigo/ Amigo 2 Compact ¹⁾ REMS Amigo 2 ¹⁾ REMS Tornado ²⁾ REMS Magnum ²⁾	347000
Roll grooving attachment R 300	Ridgid 300	347001
Roll grooving attachment R 535	Ridgid 535	347002
Roll grooving attachment N80A	Rex/Rothenberger/ Super-Ego N80A	347003
Roll grooving attachment Delta 4	Rex Delta 4"	347004

¹⁾ Conversion kit Amigo/Amigo 2/Amigo 2 Compact (Art. No. 347007) required. Can be used for roll grooving devices manufactured from 2014 onwards.

²⁾ Can only be used for roll grooving up to DN 200, 8" on T versions. Roll grooving attachments for other makes on request.

Accessories

Description	Art.-No.
Grooving rollers 1–1½" (pair)	347030
Grooving rollers INOX 1–1½" (pair)	347053
Grooving rollers 2–6" (pair)	347035
Grooving rollers INOX 2–6" (pair)	347046
Grooving rollers 8–12" (set)	347040
Grooving rollers INOX 8–12" (pair)	347047
Grooving rollers Cu 54–159 (pair) for Cu pipes	347034
Conversion kit Amigo/Amigo 2/Amigo 2 Compact	347007

REMS Herkules 3B, material support, see page 94.



REMS Collum RG

Roll grooving machine

Powerful roll grooving machine for fast, economical grooving of pipes for pipe coupling systems. For installation, sprinkler lines, commercial heating, industry and mining. For job site and workshop.

Steel pipes DN 25–300
1–12"
s ≤ 7.2 mm

Stainless steel pipes, copper, aluminium, PVC pipes

REMS Collum RG – electrical roll grooving up to 12". Fast and economical feed of the pressure roller with oil-hydraulic pressure cylinder.

Design

Robust, compact construction suitable for building sites. Favourable dimensions, favourable weight, roll grooving device with drive machine only 31 kg. For work bench. Stand or wheel stand as an accessory, for easy transport, optimum working height and stable positioning.

Drive

Fast and powerful, e.g. roll grooving of 6" steel pipe with REMS Collum RG in just 52 s. Sturdy, compact gear, maintenance-free. Robust, powerful 1200 W universal motor (REMS Collum RG and REMS Collum RG 2 Compact) or 1700 W universal motor (REMS Collum RG 2) for intensive use at large dimensions. Safety switch. Safety foot switch for ergonomic working as an accessory.

Roll grooving attachment

Compact, job site-proven. Robust metal housing for tough use. Handy, easy to transport, only 26 kg. Oil hydraulic pressure cylinder for powerful in-feed of pressure roller. Pressure build-up with hydraulic hand pump. Built-in ring gauge for automatic groove-depth-stop.

Grooving rollers

The proven REMS grooving rollers with perfectly size-adjusted pressure rollers and counterpressure rollers with well gripping axial knurls guarantee a secure rotation of the pipe and precise grooving. Grooving rollers machined from hardened special steel ensure extremely long service life. 3 pairs of groove rollers (pressure roller, counter-pressure roller) for the whole working range DN 25–300, 1–12", easy change. Grooving rollers Cu (pressure roller, counterpressure roller) for copper pipe 54–159 mm. Groove rollers INOX (pressure roller made of stainless steel, counter-pressure roller made of toughened, specially hardened steel, nickel-plated) for stainless steel pipes 2–6" and 8–12". Grooving rollers for aluminium, PVC pipes on request.



German Quality Product

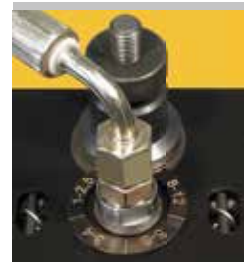

Tested by electrosuisse >>>



Wheel stand (Accessory)

Herkules 3B (Accessory)

Supply format

REMS Collum RG. Roll grooving attachment for grooving pipes of pipe coupling systems DN 25–300, 1–12". Roll grooving attachment, hydraulic hand pump, built-in ring gauge for automatic groove-depth-stop, 1 pair of groove rollers (pressure roller, counter-pressure roller) 2–6", Allen key. Choice of 3 drive units, with maintenance-free gear, powerful universal motor, safety switch. For workbench, stand or wheel stand. In a carton.

Description	Version	Art.-No.
Collum RG	Universal motor 230 V, 50–60 Hz, 1200 W, overload protection. 29 min ⁻¹	347006
Collum RG 2	Universal motor 230 V, 50–60 Hz, 1700 W. 28 min ⁻¹	347008
Collum RG 2 Compact	Universal motor 230 V, 50–60 Hz, 1200 W, overload protection. 26 min ⁻¹	347009

Other voltages on request.

Accessories

Description	Art.-No.
Stand	849315
Wheel stand	849310
Safety foot switch	347010

REMS Herkules 3B, material support, see page 94.

Grooving rollers and other accessories, see page 48.



REMS Magnum RG

Roll grooving machine

Robust, compact high performance machine with roll grooving attachment for pipe grooving of pipe coupling systems. For installation, sprinkler lines, commercial heating lines, industry and mining. For job site and workshop.

Steel pipes	DN 25–300 1–12" s ≤ 7.2 mm
-------------	----------------------------------

Stainless steel pipes, copper, aluminium, PVC pipes	
---	--

Pipe threads $\frac{1}{16}$ –2", 16–63 mm, bolt threads 6–60 mm, $\frac{1}{4}$ –2", with conversion kit.	
--	--

REMS Magnum RG – the compact up to 12". Immensely powerful and extremely fast. Feed of the pressure roller with oil-hydraulic pressure cylinder.

Design

Robust, compact, job site-proven design. Favorable size and weight, e.g. REMS Magnum 2010 RG-T only 68 kg. Tool support. For workbench. Stand, collapsible wheel stand or wheel stand with material shelf, as an accessory, for easy transport, optimum working height and stable positioning.

Drive

Immensely powerful and fast, e.g. roll grooving of 6" steel pipe with REMS Magnum 2010 RG-T in just 40 s. Completely maintenance-free gear which runs in a sealed oil bath. Choice of 3 powerful motors (see REMS Magnum page 32). Operator-friendly safety foot switch with emergency-stop, 2-step, can be loaded with the full body weight during operation.

Roll grooving attachment

Compact, job site-proven. Robust metal housing for tough use. Handy, easy to transport, only 26 kg. Oil hydraulic pressure cylinder for powerful in-feed of pressure roller. Pressure build-up with hydraulic hand pump. Built-in ring gauge for automatic groove-depth-stop.

Grooving rollers

The proven REMS grooving rollers with perfectly size-adjusted pressure rollers and counterpressure rollers with well gripping axial knurls guarantee a secure rotation of the pipe and precise grooving. Grooving rollers machined from hardened special steel ensure extremely long service life. 3 pairs of groove rollers (pressure roller, counter-pressure roller) for the whole working range DN 25–300, 1–12", easy change. Grooving rollers Cu (pressure roller, counterpressure roller) for copper pipe 54–159 mm. Groove rollers INOX (pressure roller made of stainless steel, counter-pressure roller made of toughened, specially hardened steel, nickel-plated) for stainless steel pipes 2–6" and 8–12". Grooving rollers for aluminium, PVC pipes on request.

Conversion kit for threading

Tool set $\frac{1}{4}$ –2" complete with universal automatic die head, dies for pipe threads, tapered, ISO 7-1 (DIN 2999, BSPT) R $\frac{1}{2}$ – $\frac{3}{4}$ and R 1–2" right-hand, pipe cutter, inner pipe deburrer, pressing lever, pump for automatic oiling, oil basin, chip tray.



German Quality Product



Stand
(Accessory)



Wheel stand (Accessory)

Herkules 3B (Accessory)



Collapsible wheel stand (Accessory)

Supply format

REMS Magnum RG. Roll grooving machine for pipe grooving of pipe coupling systems DN 25–300, 1–12". With maintenance-free gear, safety foot switch with emergency-stop, self-tightening quick-action hammer chuck, rear centering device, automatic lubrication and cooling, tool support. Choice of 3 motors. Roll grooving attachment, hydraulic hand pump, built-in ring gauge with automatic groove-depth-stop, 1 set of grooving rollers (pressure roller, counterpressure roller) 2–6", hexagon key. For workbench, stand, collapsible wheel stand or wheel stand with material shelf. In a carton.

Description	Version	Art.-No.
2000 RG-T	Universal motor 230 V or 110 V, 50–60 Hz, 1700 W. 53 rpm.	340230
2010 RG-T	Pole-reversible capacitor motor 230 V, 50 Hz, 2100 W. 52/26 rpm, also under full load. Extremely quiet running.	340231
2020 RG-T	Pole-reversible 3~ induction motor 400 V, 50 Hz, 2000 W. 52/26 rpm, also under full load. Extremely quiet running.	340232

Other voltages on request.







Accessories

Description	Art.-No.
Stand	344105
Wheel stand with material support	344100
Collapsible wheel stand	344150
REMS Herkules 3B , material support, see page 94.	
Grooving rollers and other accessories, see page 48.	
Conversion kit Magnum RG-T to L-T for threading.	340110





Sawing

	Universal electric reciprocating saws	56
	Electric reciprocating pipe saws	58
	Pneumatic reciprocating pipe saw	60
	Cordless universal reciprocating saw	61
	Saw blades for reciprocating saws	62
	Circular pipe sawing machine	64
	Universal circular metal sawing machine	65

REMS reciprocating saws Legend



Aggressive orbital action by vertical hacking motion of saw blade provides forceful, fast forward feed, excellent chip flow and long service life of saw blades.

Fixed orbital action, running in needle bearings, ensures long-lasting and forceful sawing also during extreme load conditions, e.g. sawing of steel pipe. Adjustable mechanisms with a great variety of parts and a reduced system stability do not withstand the high in-feed pressure and the heavy-duty requirements of forceful cutting of steel pipes, particularly when a guide support with leverage is being used.



Sturdy, square lift rod in special solid steel, mounted precisely in needle bearings towards the force direction and along the complete stroke length, for distortion-free, precise cutting also during tough use and by applying multiple sawing force, e.g. using a guide support with leverage. For extremely long service life.

Special high sliding silicone gasket protects gear against water and dust.



ANC

Super stable, water and dust resistant, maintenance-free oscillating gear enables a simultaneous generation of saw and orbital stroke of lift rod and saw blade. Allround needle bearing mounted crank drive (ANC) reduces friction, heat generation, wear. Thus long service life also at extreme sawing.

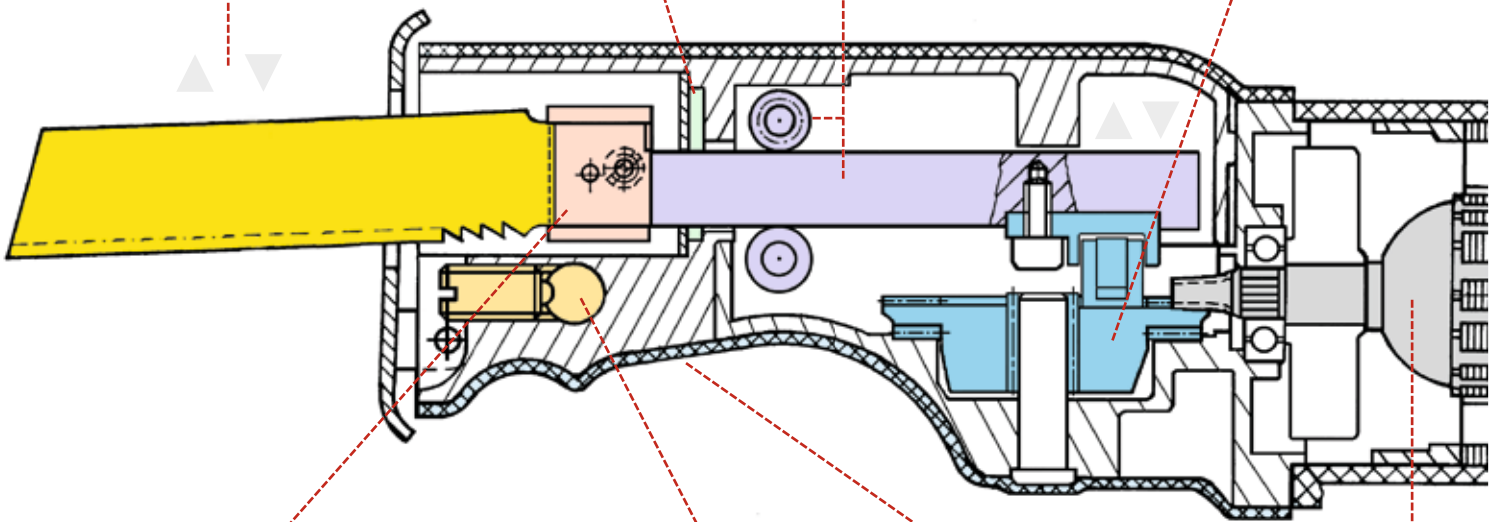

Universal saw blade clamp for mounting all saw blades – with universal or double tang – without changing or turning the saw blade thrust piece.



Guide support for 400 % additional sawing force for fast, effortless sawing. Also for effortless demolition work.

V/bar
Drive motors
230 V, 110 V, 48 V,
18 V, 6 bar

Ergonomically shaped front housing grip with slip resistant protection cover, for forceful feed forward while sawing free-hand.



Vario-Electronic

Electronic stepless speed control of drive unit for sensitive start-sawing and for stroke selection during sawing according to the material. The stroke speed is controlled continuously by variable pressure on the touch switch from 0 to 2,800 rpm (REMS Puma VE), 0 to 2,400 rpm (REMS Cat ANC VE, REMS Tiger ANC VE) or 0 to 1,800 rpm (REMS Akku-Cat ANC VE) (accelerator switch).



Ideal speed

Deliberately fixed speed. Therefore optimum cutting speed for maximum protection of motor and gear and maximum service life of saw blades. The ideal cutting speed of 2,400 rpm has been determined by extensive sawing tests with steel pipe which lead to optimum performance in combination with the aggressive, fixed orbital action, guide support and REMS special saw blade.



Power-transferring guide support

For assembly and dismantling. Guide support with five-fold force transmitting leverage allows effortless, fast, right angled sawing anywhere on site, without a vice. Ideal handling, easy and rapid to operate, positioned with one hand only for chucking and sawing. No loose swinging chain and cumbersome handling as with chain vice. No danger of jamming by limitation of swing angle. 400 % additional sawing force for effortless, super fast sawing during assembly and dismantling, e.g. 2" steel pipe in only 8 s. Straight machine handle for optimum forward feed.



Speed-Regulation

Stepless electronic speed control of drive unit for selecting the speed according to the material. Ideal for sawing stainless steel pipe, cast pipe and for sawing boilers, tanks, bath tubs etc. The speed is continuously adjustable between 700 and 2,200 rpm on the dial. The electronic speed control which is being used keeps the selected speed constant, also under load, including speed generator, control electronics, residual current limitation for sensitive start-sawing, motor temperature control of field wires with PTC resistance (Positive Temperature Coefficient) and stall protection of gear and motor.



Weight

High sawing efficiency at low weight by innovative, proven technology and perfect tuning of all components. For effortless, fatigue-free sawing and easy handling.



Power

All power data stated to be understood as the rated power input. The drive motors of REMS reciprocating saws have a very high efficiency of approx. 65% thanks to an outstanding technology and quality. Therefore the user has a high power output available which is useful particularly for sawing difficult-to-cut materials, e.g. steel pipe. High power output can only be used fully by levered sawing, e.g. with the REMS guide support.



Drive Motors

Depending on model universal motors of voltages of 230 V, 110 V, 48 V, battery motors 18 V or pneumatic motors for 6 bar operating pressures are used. All drive motors are extremely powerful, fulfill highest quality demands and come with large power reserves, for long service life.



Saw blade holder with quick-change system

Practical saw blade holder with quick-change system for fast saw blade changing without tools. For holding single tang saw blades.



Continuously adjustable support shoe

Swivel support shoe for safe guiding of the saw on the material to be sawn. Support shoe continuously adjustable in longitudinal direction by 40 mm for better utilisation of partially blunted saw blades and for setting the plunge-in depth of the saw blade in the material.



Anti-vibration system

Special drive technology with mass compensation and vibration damping handles. For low vibration, effortless sawing.



Saw blade can be inserted turned 180°.

Saw blade can be inserted with the teeth facing down or turned 180° facing up for cuts in confined spaces with difficult access.

REMS Puma VE

Universal electric reciprocating saw

Powerful power tool for universal free-hand sawing. Only 3.8 kg. Ideal for assembly, disassembly, repair.

Many materials, e.g. wood, wood with nails, pallets, metal, even stainless steel, cast iron, breeze blocks, plaster boards, pumice stone, brick

REMS Puma VE – the powerful universal saw with anti-vibration system. Quick saw blade change without tools. Adjustable support shoe.

Universal use

Can be used anywhere, free hand, over head, in tight corners, flush with the wall. Extremely versatile and powerful. For all sawing work on the building site and for rescue and emergency operations. Also for plunge-cut sawing.

Design

Powerful, suitable for building sites. Handy, easy grip shape. Only 3.8 kg. Ergonomically designed front housing grip with non-slip, heat insulating protective jacket with soft grip, for powerful sawing thrust. Practical D-shaped handle with vibration damping soft grip. Drive rod runs in an enclosed drive housing for safe work. Large saw blade stroke, 30 mm, for better cut clearance. Fast stroke speed up to 2,800 rpm for fast sawing thrust and effective sawing. Robust crank drive, maintenance-free. High sliding special seal. Powerful, high capacity universal motor with large power reserve, 1,300 W, safety switch. 4 m long connecting lead. Safety switch.

Anti-vibration system

Special drive technology with mass compensation and vibration damping handles. For low vibration, effortless sawing.

Vario-Electronic

Continuous electronic stroke speed control for gentle start of sawing and selection of a stroke speed suitable for the material. The stroke speed can be continuously controlled by variable pressure on the safety switch from 0 to 2,800 rpm (accelerator switch).

Saw blade holder with quick-change system

Practical saw blade holder with quick-change system for fast saw blade changing without tools. For holding single tang saw blades. Saw blade can be inserted with the teeth facing down or turned 180° facing up for cuts in confined spaces with difficult access.

REMS saw blades

Full range of REMS saw blades for free-hand sawing of different materials (page 63).

Continuously adjustable support shoe

Swivel support shoe for safe guiding of the saw on the material to be sawn. Support shoe continuously adjustable in longitudinal direction by 40 mm for better utilisation of partially blunted saw blades and for setting the plunge-in depth of the saw blade in the material. For economical working.

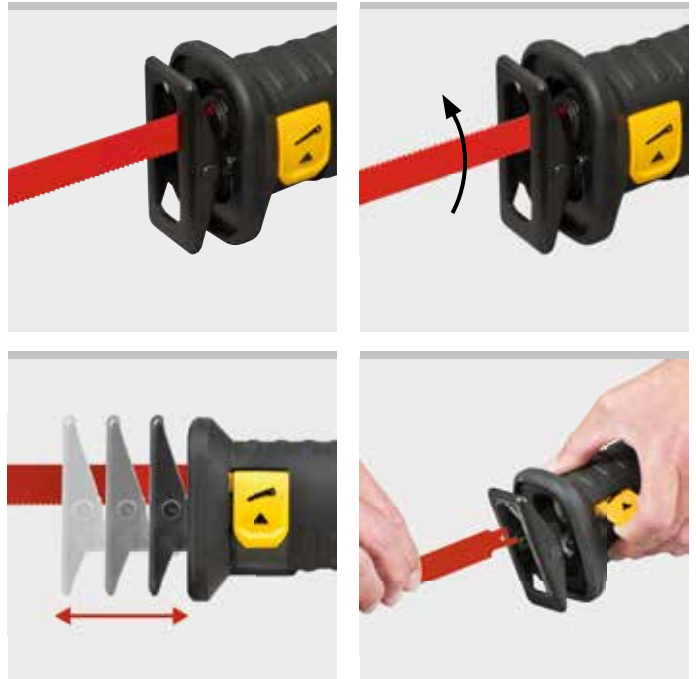
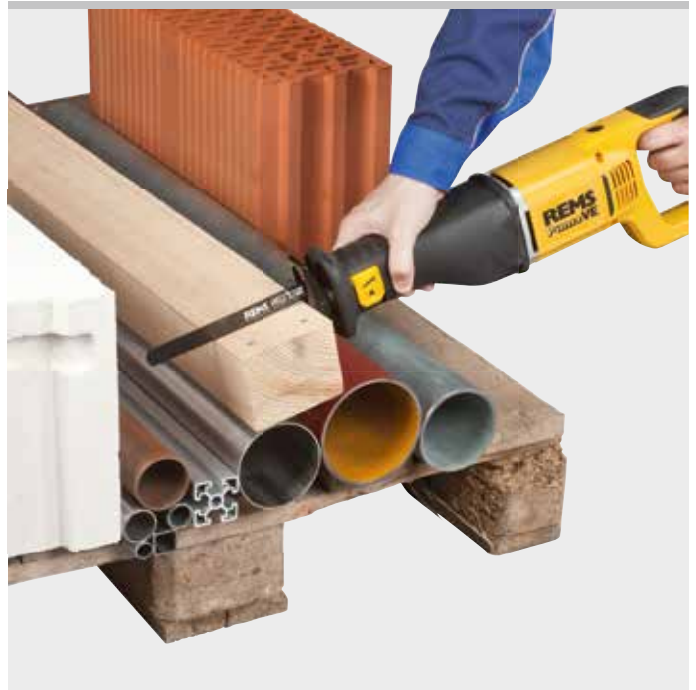

Supply format

REMS Puma VE Set. Electric universal reciprocating saw with Vario-Electronic (VE) for free-hand sawing, with anti-vibration system. Drive machine with D-shaped handle with soft grip, maintenance-free crank drive, powerful 230 V, 50–60 Hz, 1,300 W universal motor, safety switch, connecting cable 4 m. Continuous electronic stroke speed control (accelerator switch) 0 to 2,800 rpm. 30 mm stroke. Saw blade holder with quick-change system Adjustable support shoe. 1 REMS saw blade 210-1.8/2.5. In sturdy steel case.

	Art.-No.
	560023

Other voltages on request.

Accessories

Description	Art.-No.
REMS Puma VE drive unit	560003
REMS saw blades see page 63.	
Steel case	566051

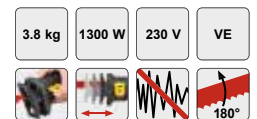

REMS Cat ANC VE

Universal electric reciprocating saw

Powerful, robust, handy power tool for universal free-hand sawing. Only 3.0 kg. Ideal for assembly, dismantling, repair.

Many materials, e.g. wood, wood with nails, pallets, metal, even stainless steel, cast iron, breeze blocks, plaster boards, pumice stone, brick

Especially also for steel pipes

REMS Cat ANC VE – saws anything, anywhere. Extremely versatile and powerful. Robust and handy.

Universal use

Ready for use anywhere, free-hand, overhead, in confined areas, flush to wall. Extremely versatile and efficient. Especially also for sawing metal pipes, sawing up boilers, tanks, bath tubs. For rescue and emergency operations. Also for plunge-cut sawing.

Design

Robust, job site-proven. Slender, handy design. Super light, only 3.0 kg. Ergonomically shaped front housing grip with slip resistant, heat insulating protection cover with soft grip, for forceful feed forward. Proven D-shaped handle. Swivel support shoe for safe guiding of the saw on the material to be sawn. High sliding silicone gasket protects gear against water and dust. Powerful universal motor with ample reserve capacity, 1050 W. Safety tip switch.

Sturdy, square lift rod

In special solid steel, mounted precisely in needle bearings towards the force direction and along the complete stroke length, for distortion-free, precise cutting also during tough use. For extremely long service life. Drive rod runs in an enclosed housing for safe work.

Oscillating drive with ANC

Super stable, water and dust resistant, maintenance-free oscillating drive for simultaneous generation of sawing stroke and orbital action of lift rod and saw blade. Allround needle bearing mounted crank drive (ANC), reduces friction, heat generation, wear. For long service life of drive also at extreme sawing.

Aggressive orbital action

Aggressive orbital action by vertical hacking motion of saw blade provides forceful, fast forward feed, excellent chip flow and long service life of saw blades. Fixed orbital action, running in needle bearings, ensures long-lasting and forceful sawing also during extreme load conditions, e.g. sawing of steel pipe.

Vario-Electronic

Electronic stepless speed control of drive unit for sensitive start sawing and for speed selection during sawing. The speed is controlled by pressing the tip switch steplessly from 0 to 2,400 rpm (acceleration switch).

Universal saw blade clamp

All saw blades – with universal or double tang – can be clamped without changing or turning the saw blade thrust piece.

REMS universal saw blade

Only 1 REMS universal saw blade (page 62) for all sawing work instead of many different saw blades. Double tang for free-hand sawing and sawing with guide holder.

REMS saw blades

Full range of REMS saw blades for free-hand sawing of different materials (page 63).



ANC

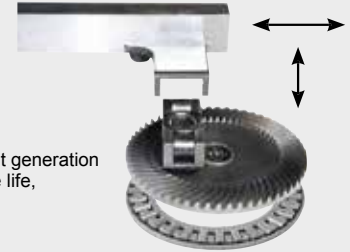

- reduced friction and wear
- substantially reduced heat generation
- for extremely long service life, also during tough use



German Quality Product

Tested by electro**suisse** >>>

Supply format

REMS Cat ANC VE Set. Electric universal reciprocating saw with Vario-Electronic (VE) for free-hand sawing. Drive unit with D-shaped handle, maintenance-free, water and dust resistant oscillating drive with allround needle bearing mounted crank drive (ANC), aggressive orbital action, powerful universal motor 230 V or 110 V, 50–60 Hz, 1050 W, safety tip switch. Electronic stepless speed control (acceleration switch) 0 to 2,400 rpm. Universal saw blade clamp. Hexagon key. 1 REMS universal saw blade 150-1.8/2.5. In sturdy steel case.

	Art.-No.
	560040

Other voltages on request.

Accessories

Description	Art.-No.
REMS Cat ANC VE drive unit	560004
REMS saw blades see page 62–63.	
Steel case	566005



Powerful, robust, handy power tool with force-transmitting guide holder for effortless, fast, right-angled sawing everywhere on site, without a vice. Also for universal free-hand sawing. Only 3.0 kg. Ideal for assembly, dismantling, repair.

Ideal for steel pipes and others.

Many materials, e.g. wood, wood with nails, pallets, metal, even stainless steel, cast iron, breeze blocks, plaster boards, pumice stone, brick

For materials that are difficult to cut, e.g. stainless steel pipes, hard cast iron, use the REMS Tiger ANC SR with electronic stroke speed control.

REMS Tiger – the saw for the pipe fitter.

Saws effortless, fast, right angle.

Robust and handy.

Power-transferring guide support

400% additional sawing force for effortless, super fast sawing, e.g. 2" steel pipe in only 8 s. For assembly and dismantling. Guide support with five-fold force transmitting leverage allows effortless, fast, right angled sawing anywhere on site, without a vice. Ideal handling, easy and rapid to operate, positioned with one hand only for chucking and sawing. No loose swinging chain and cumbersome handling as with chain vice. No danger of jamming by limitation of swing angle. For optimum in-feed with guide support a straight machine handle is advantageous.

Right angle sawing

Right angle cut thanks to REMS guide support and REMS special saw blade. Essential for subsequent operations in pipe installation.

REMS special saw blade

REMS special saw blade (page 62), extra thick, rigid and unbendable, double tang, absolutely essential for right-angled sawing and fast disassembly of steel pipes with force-transmitting guide holder.

REMS universal saw blade

Only 1 REMS universal saw blade (page 62) for all sawing work instead of many different saw blades. Double tang for free-hand sawing and sawing with guide holder.

REMS saw blades

Full range of REMS saw blades for free-hand sawing of different materials (page 63).

Universal saw blade clamp

All saw blades – with universal or double tang – can be clamped without changing or turning the saw blade thrust piece.

Design

Robust, job site-proven. Slender, handy design. Super light, only 3.0 kg. Can be used anywhere. Ergonomically shaped front housing grip with slip resistant protection cover for forceful feed forward during free-hand sawing. Choice of practical D-shaped handle, advantageous during free-hand sawing, or straight machine handle, advantageous during sawing with guide support. Swivel support shoe for safe guiding of the saw on the material to be sawn. High sliding silicone gasket protects gear against water and dust. Powerful universal motor with ample reserve capacity, 1050 W respectively 1400 W (REMS Tiger ANC SR). Safety tip switch. Choice of drive unit with fixed, ideal speed, electronic speed control (Vario-Electronic) or electronic speed regulation. Overload protection (REMS Tiger ANC) protects motor, gear and saw blade. The electronic tachometer speed controller (REMS Tiger ANC SR) used for control keeps the preselected number of strokes constant even under load and includes tachogenerator, electronic control, start-up current limiter for soft start-up, overheating protection by temperature monitoring of the field winding of the motor with PTC resistance (Positive Temperature Coefficient) and blocking protection for gearbox and motor.

Sturdy, square lift rod

In special solid steel, mounted precisely in needle bearings towards the force direction and along the complete stroke length, for distortion-free, precise cutting also during tough use. For extremely long service life. Drive rod runs in an enclosed housing for safe work.

Oscillating drive with ANC

Super stable, water and dust resistant, maintenance-free oscillating drive for simultaneous generation of sawing stroke and orbital action of lift rod and saw blade. Allround needle bearing mounted crank drive (ANC) reduces friction, heat generation, wear. For long service life of drive also at extreme sawing.

Aggressive orbital action

Aggressive orbital action by vertical hacking motion of saw blade provides forceful, fast forward feed, excellent chip flow and long service life of saw blades. Fixed orbital action, running in needle bearings, ensures long-lasting and forceful sawing also during extreme load conditions, e.g. sawing of steel pipe. Adjustable mechanisms with a great variety of parts and a reduced system stability do not withstand the high feed forward pressure and the heavy-duty requirements of forceful cutting of steel pipes, particularly when a guide support with leverage is being used.

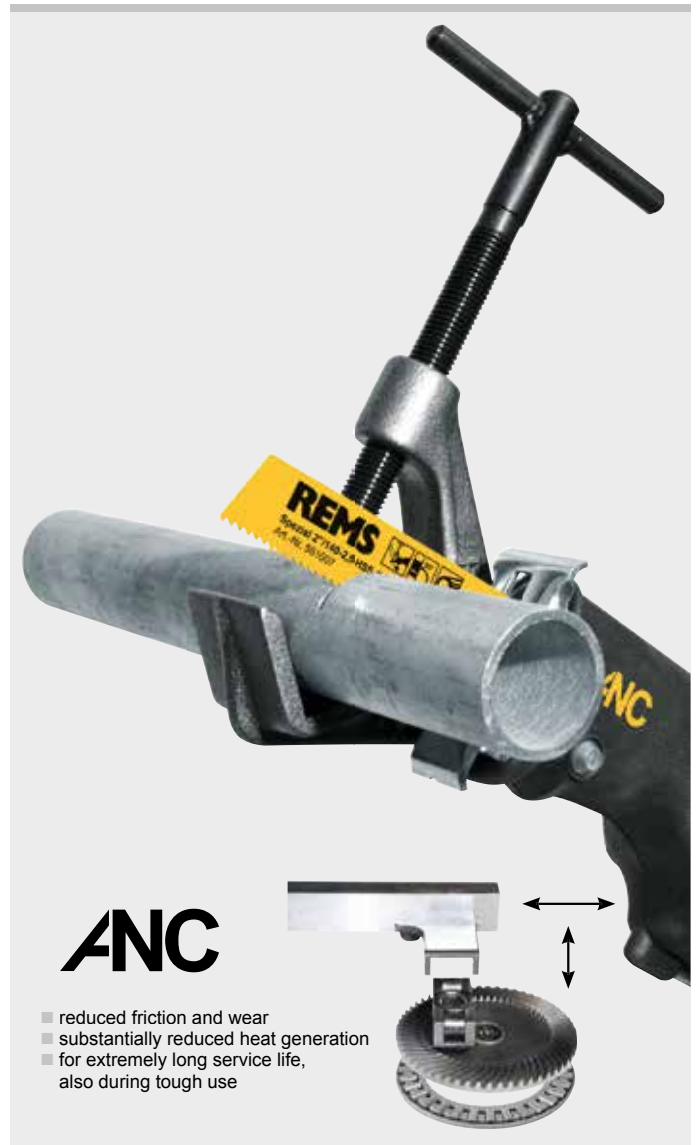

German Quality Product

Tested by electrosuisse >>>

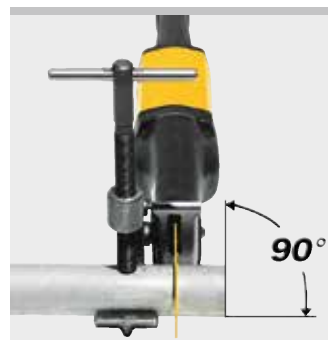

REMS Tiger ANC/VE/SR

Electric reciprocating pipe saws

Ideal speed (REMS Tiger ANC)

Deliberately fixed speed. Therefore optimum cutting speed for maximum protection of motor and gear and maximum service life of saw blades. The ideal cutting speed of 2,400 rpm has been determined by extensive sawing tests with steel pipe which lead to optimum performance in combination with the aggressive, fixed orbital action, guide support and REMS special saw blade.

Vario-Electronic (REMS Tiger ANC VE)

Electronic stepless speed control of drive unit for sensitive start-sawing and for speed selection during sawing according to the material. Also for plunge-cut sawing. The stroke speed can be continuously controlled by variable pressure on the safety switch from 0 to 2,400 rpm (accelerator switch).

Speed Regulation (REMS Tiger ANC SR)

Stepless electronic speed control of drive unit for selecting the stroke according to the material. Ideal for sawing stainless steel pipe, cast pipe and for sawing boilers, tanks, bath tubs etc. Also for plunge-cut sawing. The number of strokes is steplessly adjustable on the dial from 700 to 2,200 rpm.



Anywhere, without vice!



German Quality Product



Supply format

REMS Tiger ANC Set. Electric reciprocating pipe saw for effortless, fast, right angle sawing with guide support and for free-hand sawing. Drive unit with straight machine handle, maintenance-free, water and dust resistant oscillating drive with allround needle bearing mounted crank drive (ANC), aggressive orbital action, powerful universal motor 230 V or 110 V, 50–60 Hz, 1050 W, safety tip switch. Fixed stroke 2,400 rpm. Overload protection. Universal saw blade clamp. Hexagon key. Guide support 2". 2 pcs. REMS special saw blades 2"/140-3,2. In sturdy steel case.

	Art.-No.
	560020

Other voltages, also 48 V on request.

Supply format

REMS Tiger ANC VE Set. Electric reciprocating pipe saw with Vario-Electronic for effortless, fast, right angle sawing with guide support and for free-hand sawing. Drive unit with D-shape handle, maintenance-free, water and dust resistant oscillating drive with allround needle bearing mounted crank drive (ANC), aggressive orbital action, powerful universal motor 230 V or 110 V, 50–60 Hz, 1050 W, safety tip switch. Electronic stepless speed control (acceleration switch) 0 to 2,400 rpm. Universal saw blade clamp. Hexagon key. Guide support 2". 2 pcs. REMS special saw blades 2"/140-3,2. In sturdy steel case.

	Art.-No.
	560027

Other voltages on request.

Supply format

REMS Tiger ANC SR Set. Electric reciprocating pipe saw with speed regulation (SR) for effortless, fast, right angle sawing with guide support and for free-hand sawing. Drive unit with straight machine handle, maintenance-free, water and dust resistant oscillating drive with allround needle bearing mounted crank drive (ANC), aggressive orbital action, powerful universal motor 230 V or 110 V, 50–60 Hz, 1400 W, safety tip switch. Stepless electronic speed control 700 to 2,200 rpm with sensitive start-sawing, speed generator, temperature control and stall protection. Universal saw blade clamp. Hexagon key. Guide support 2". 2 pcs. REMS special saw blades 2"/140-3,2. In sturdy steel case.

	Art.-No.
	560026

Other voltages on request.

Accessories

Description	Art.-No.
REMS Tiger ANC drive unit	560000
REMS Tiger ANC VE drive unit	560008
REMS Tiger ANC SR drive unit	560001
REMS saw blades see page 62–63.	
Guide support 2" , for pipes Ø ½–2"	563000
Guide support 4" , for pipes Ø 2½–4"	563100
Guide support 6" , for pipes Ø 5–6"	563200
Dual purpose holder for sawing and threading, with REMS Tiger ANC and REMS Amigo E, Amigo, Amigo 2	543100
Protective cap for guide support 2" , 4" and 6", for clamping of thin-walled material	563008
Steel case	566051



REMS Tiger ANC pneumatic

Pneumatic reciprocating pipe saw

Powerful, robust, handy compressed air tool with force-transmitting guide holder for effortless, fast, right-angled sawing everywhere on site, without a vice. Also for universal free-hand sawing. Ideal for use in dangerous, e.g. in wet environment. For assembly, dismantling, repair.

Ideal for steel pipes and others.

Many materials, e.g. wood, wood with nails, pallets, metal, even stainless steel, cast iron, breeze blocks, plaster boards, pumice stone, brick

For materials that are difficult to cut, e.g. stainless steel pipes, hard cast iron, use the REMS Tiger ANC SR with electronic stroke speed control.

REMS Tiger pneumatic – for sawing in dangerous environment.

Saws effortless, fast, right-angle. Force transmitting guide support for 400 % more sawing power. Sturdy, square lift rod. Oscillating drive with ANC.

Aggressive orbital action for fast feed forward sawing and long service life of saw blades. Universal saw blade clamp.

Design

Robust, job site-proven. Slender, handy design. Super light, only 3.8 kg. Can be used anywhere. Ergonomically shaped front housing grip with slip resistant, heat insulating protection cover with soft grip, for forceful feed forward during free-hand sawing. Swivel support shoe for safe guiding of the saw on the material to be sawn. High sliding silicone gasket protects gear against water and dust. Powerful pneumatic motor with ample reserve capacity, 1000 W. Stroke speed control (accelerator switch) 0 to 1,700 rpm. Operating pressure 6 bar, air consumption $\leq 1.6 \text{ m}^3/\text{min}$. Safety switch with lock.

Additional description see REMS Tiger ANC, page 58 – 59.



German Quality Product

Supply format

REMS Tiger ANC pneumatic Set. Pneumatic reciprocating pipe saw for effortless, fast, right angle sawing with guide support and for free-hand sawing. Drive unit with straight machine handle, maintenance-free, water and dust resistant oscillating drive with allround needle bearing mounted crank drive (ANC), aggressive orbital action, powerful pneumatic 1000 W, operating pressure 6 bar, safety switch with lock. Stroke speed control (accelerator switch) 0 to 1,700 rpm. Air inlet hose, air outlet hose. Universal saw blade clamp. Hexagon key. Guide support 2". 2 pcs. REMS special saw blades 2"/140-3.2. In sturdy steel case.

	Art.-No.
	560022

Accessories

Description	Art.-No.
REMS saw blades see page 62–63.	
REMS Tiger ANC pneumatic drive unit	560002
Guide support 2" , for pipes $\varnothing \frac{1}{2}$ –2"	563000
Guide support 4" , for pipes $\varnothing 2\frac{1}{2}$ –4"	563100
Guide support 6" , for pipes $\varnothing 5$ –6"	563200
Dual purpose holder for sawing and threading, with REMS Tiger ANC and REMS Amigo E, Amigo, Amigo 2	543100
Protective cap for guide support 2" , 4" and 6", for clamping of thin-walled material	563008
Steel case	566051



3.8 kg 1000 W 6 bar



REMS Akku-Cat ANC VE

Cordless universal reciprocating saw

Powerful, robust, handy power tool for universal free-hand sawing. Only 3.1 kg. Ideal for assembly, dismantling, repair.

Many materials, e.g. wood, wood with nails, pallets, metal, even stainless steel, cast iron, breeze blocks, plaster boards, pumice stone, brick

Especially also for steel pipes

REMS Akku-Cat ANC VE Li-Ion – saws anything, anywhere. Extremely versatile and powerful. Robust and handy.

Universal use

Ready for use anywhere, free-hand, overhead, in confined areas, flush to wall. Mains independent. Extremely versatile and efficient, particularly for metal. Saws metal pipes, boilers, tanks, bath tubs, window frames, etc., for rescue and disaster service operations. Also for plunge-cut sawing.

Design

Robust, job site-proven. Slender, handy design. Super light, drive unit with battery only 3.1 kg. Ergonomically shaped front housing grip with slip resistant, heat insulating protection cover with soft grip, for forceful feed forward. Proven D-shaped handle. Swivel support shoe for safe guiding of the saw on the material to be sawn. High sliding silicone gasket protects gear against water and dust. Powerful 18 V battery motor with ample reserve capacity, 500 W output. Safety tip switch. Electronic charging status check with low discharge protection.

Sturdy, square lift rod

In special solid steel, mounted precisely in needle bearings towards the force direction and along the complete stroke length, for distortion-free, precise cutting also during tough use. For extremely long service life.

Oscillating drive with ANC

Super stable, water and dust resistant, maintenance-free oscillating drive for simultaneous generation of sawing stroke and orbital action of lift rod and saw blade. Allround needle bearing mounted crank drive (ANC) reduces friction, heat generation, wear. For long service life of drive also at extreme sawing.

Vario-Electronic

Electronic stepless speed control of drive unit for sensitive start sawing and for speed selection during sawing. The speed is controlled by pressing the tip switch steplessly from 0 to 1,800 rpm (acceleration switch).

Aggressive orbital action

Aggressive orbital action by vertical hacking motion of saw blade provides forceful, fast forward feed, excellent chip flow and long service life of saw blades. Fixed orbital action, running in needle bearings, ensures long-lasting and forceful sawing also during extreme load conditions, e.g. sawing of steel pipe.

Li-Ion PLUS technology

Highly resistant Li-Ion 18 V battery with 3.0 Ah capacity, for long service life. Powerful and light. Total discharge and overload protection with single cell monitoring. Temperature monitoring during the charging process. Operating temperature range – 10 to + 60 °C. No memory effect for maximum battery power. Rapid charger for short charging times.

Universal saw blade clamp

All saw blades – with universal or double tang – can be clamped without changing or turning the saw blade thrust piece.

REMS saw blades

See page 62–63.

Supply format

REMS Akku-Cat ANC VE Li-Ion. Battery driven universal reciprocating saw with Vario-Electronic (VE) for free-hand sawing. Drive unit with D-shaped handle, maintenance-free, water and dust resistant oscillating drive with allround needle bearing mounted crank drive (ANC), aggressive orbital action, powerful 18 V battery motor, safety tip switch. Electronic stepless speed control (acceleration switch) 0 to 1,800 rpm. Battery Li-Ion 18 V, 3.0 Ah, rapid charger Li-Ion/Ni-Cd 230 V or 110 V, 50–60 Hz, 50 W. Universal saw blade clamp. Hexagon key. 1 pcs REMS universal saw blade 150-1,8/2,5. In sturdy case.

	Art.-No.
	560051

Other voltages on request.

Accessories

Description	Art.-No.
REMS saw blades see page 62–63.	
REMS Akku-Cat ANC VE drive unit, without battery	560009
Battery Li-Ion 18 V, 3.0 Ah	565225
Rapid charger Li-Ion/Ni-Cd 230 V, 50–60 Hz, 65 W	571560
Case with inlay	566025



German Quality Product







REMS saw blades

For REMS Puma VE, REMS Cat ANC VE, REMS Tiger ANC/VE/SR, REMS Akku-Cat ANC VE and other makes

Saw blades for free-hand sawing for different materials.





















Alternating tooth pitch (combi-teeth) for fast, smooth cut, also when sawing mixed materials (wood/metal).

Flexible saw blades, also for sawing flush with wall.

-  Corrugated teeth for smooth cut with low tooth pitch.
-  Straight-set teeth for aggressive cut with coarse tooth pitch.
-  Straight teeth for saw blades with very wide carbide teeth.
-  Carbide-granulate for materials that are difficult to cut.

















German Quality Product



















REMS saw blades for metal → REMS Puma, REMS Cat, REMS Tiger, etc.	Length mm	Tooth pitch mm	Material*	Teeth	Colour			Art.-No.
REMS saw blade 150-1 sheet metal, metal, also stainless steel, ≥ 1.2 mm	150	1	HSS-Bi flexible		red	5		561105
REMS saw blade 200-1 sheet metal, metal, also stainless steel, ≥ 1.2 mm	200	1	HSS-Bi flexible		red	5		561106
REMS saw blade 90-1,4 , curved blade metal, also stainless steel, ≥ 1.5 mm	90	1,4	HSS-Bi		red	5		561107
REMS saw blade 150-1,4 metal, also stainless steel, ≥ 1.5 mm	150	1,4	HSS-Bi flexible		red	5		561104
REMS saw blade 200-1,4 metal, also stainless steel, ≥ 1.5 mm	200	1,4	HSS-Bi flexible		red	5		561108
REMS saw blade 100-1,8 metal, also stainless steel, ≥ 2 mm	100	1,8	HSS-Bi flexible		red	5		561101
REMS saw blade 150-1,8 metal, also stainless steel, ≥ 2 mm	150	1,8	HSS-Bi flexible		red	5		561103
REMS saw blade 200-1,8 metal, also stainless steel, ≥ 2 mm	200	1,8	HSS-Bi flexible		red	5		561102
REMS saw blade 200-2,5 metal, also stainless steel, ≥ 3 mm	200	2,5	HSS-Bi flexible		red	5		561109
REMS saw blade 280-2,5 metal, also stainless steel, ≥ 3 mm	280	2,5	HSS-Bi flexible		red	5		561112

German Quality Product



REMS saw blades for wood and metal → REMS Puma, REMS Cat, REMS Tiger, etc.	Length mm	Tooth pitch mm	Material*	Teeth	Colour			Art.-No.
REMS saw blade 210-1,8/2,5 round tip, no sticking pallets, wood, wood with nails, metal ≥ 2.5 mm	210	Combo 1,8/2,5	HSS-Bi flexible		black	5		561113
REMS saw blade 150-2,5 wood, wood with nails, pallets, metal ≥ 3 mm	150	2,5	HSS-Bi flexible		black	5		561110
REMS saw blade 225-2,5 , extra thick, for disassembly wood, wood with nails, metal ≥ 3 mm	225	2,5	HSS-Bi		black	3		561114
REMS saw blade 300-2,5 , extra thick, for disassembly wood, wood with nails, metal ≥ 3 mm	300	2,5	HSS-Bi		black	3		561116
REMS saw blade 300-4,2 wood	300	4,2	WS		black	5		561111
REMS saw blade 225-3,2/5,0 wood, wood with nails	225	Combo 3,2/5,0	HSS-Bi flexible		black	5		561117
REMS saw blade 290-5,0/6,35 green wood	290	Combo 5,0/6,35	WS		black	5		561118
REMS saw blade 150-6,35 wood	150	6,35	WS		black	5		561119



REMS saw blades for different purposes → REMS Puma, REMS Cat, REMS Tiger, etc.	Length mm	Tooth pitch mm	Material*	Teeth	Colour			Art.-No.
REMS saw blade 150-4,2 breeze blocks, plasterboard	150	4,2	WS		white	5		561115
REMS saw blade 225-8,5 breeze blocks, hard wood	225	8,5	HM		white	1		561120
REMS saw blade 300-8,5 breeze blocks, hard wood	300	8,5	HM		white	1		561121
REMS saw blade 400-8,5 breeze blocks, hard wood	400	8,5	HM		white	1		561122
REMS saw blade 235-12 breeze blocks, pumice, brick	235	12	HM		white	1		561123
REMS saw blade 300-12 breeze blocks, pumice, brick	300	12	HM		white	1		561124
REMS saw blade 300-12 , extra high blade breeze blocks, pumice, brick	300	12	HM		white	1		561125
REMS saw blade 200 cast iron etc.	200		HM-G		white	2		561126



* HSS-Bi: bimetal high speed steel WS: tool steel HM: carbide HM-G: carbide-granulate

REMS Turbo Cu-INOX

Circular pipe sawing machine

Compact, portable circular pipe sawing machine for burr-reduced, right angle and rapid sawing. Ideal for stainless steel and copper tubes of pressfitting systems. For job site and workshop.

Stainless steel tubes, copper tubes and other materials	Ø ≤ 76 mm
REMS saw blade	Ø 225 mm

REMS Turbo Cu-INOX – burr-reduced, right angle, rapid. Burr-reduced sawing through double clamping vice. Powerful, e.g. Ø 22 mm in only 4 s. Easy to transport.

Ideal for pressfitting systems

In accordance with requirements:

Dry sawing, so no damage to O-rings from lubricants.

Burr-reduced through double clamping vice.

Optimum cutting speed prevents degradation of pipe material through overheating.

Design

Compact, robust, job site-proven. Small in size, handy, portable, only 17 kg. Easy sawing through favourable leverage effect. Fast saw blade change. Precise sawing. Mark on the saw blade protection cover showing the saw blade cutting line. Connection for driving outer/inner pipe deburrer REMS REG 10–54 E. For workbench, stand or wheel stand as an accessory, for easy transport, optimum working height and stable positioning.

Universal double clamping vice

Robust, easy-running universal double clamping vice for burr-reduced sawing. Both pipe ends remain securely clamped during sawing. Easy, secure clamping also of thin-walled pipes through inclined jaw. Only one strong clamping spindle for both clamping sides ensures even, effortless and secure clamping of the material.

Drive

Robust gear, precisely mounted in roller and needle bearings, maintenance-free. Proven universal motor, 500 W. Powerful, e.g. stainless steel pipe Ø 22 mm in only 4 s. Ideal speed 60 rpm for optimum cutting speed and smooth sawing.

REMS saw blades

Top German quality. REMS circular saw blade HSS 225 × 2 × 32, 220 teeth, for metal, adjusted to the efficiency of REMS Turbo Cu-INOX for sawing stainless steel tubes. Specially fine-toothed, hardened and ground. For easy and exact sawing. Prolonged durability. REMS circular saw blade HSS-E (cobalt alloyed) 225 × 2 × 32, 220 teeth, for metal, for even better durability. Specially fine-toothed, hardened and ground.

Outer/inner pipe deburrer

Outer/inner pipe deburrer REMS REG 10–54 E for pipes Ø 10–54 mm, Ø ½–2¼", for electric drive with the REMS Turbo Cu-INOX pipe circular sawing machine and others, see page 87.

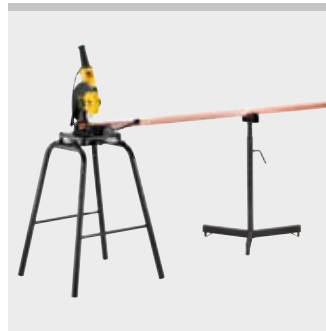

German Quality Product

Supply format

REMS Turbo Cu-INOX Basic. Circular pipe saw with universal double clamping vice for burr-reduced, right angle, rapid sawing. Ideal for stainless steel and copper tubes of pressfitting systems. For REMS saw blade Ø 225 mm. With maintenance-free gear, proven universal motor 230 V or 110 V, 50–60 Hz, 500 W. Safety tip switch, saw blade protection cover. Speed 60 rpm. Ring spanner. Hexagon key. Without saw blade. For workbench, stand or wheel stand. In a carton.

	Art.-No.	
	849006	

Other voltages on request.

Accessories

Description	Art.-No.
REMS circular saw blade HSS for metal, specially for stainless steel pipes, fine-toothing, 225 × 2 × 32, 220 teeth.	849703
REMS circular saw blade HSS-E (cobalt alloyed) circular saw blade HSS-E (cobalt alloyed) toothing, 225 × 2 × 32, 220 teeth. Very long service life.	849706
REMS REG 10–54 E outer/inner pipe deburrer, see page 87	
Stand	849315
Wheel stand	849310
REMS Jumbo , folding workbenches, see page 93.	
REMS Herkules , material supports, see page 94.	



REMS Turbo K

Universal circular metal sawing machine with automatic cooling lubricant unit

Compact, mobile, universal circular metal sawing machine for installation, metal working and industry. For job site and workshop.

↩	○	□	▭	└	●	■	▬
90° ⊕	78	55	70×50	50×50	40	40	50×30
45° ⊕	60	55	60×40	50×50	40	40	50×30

REMS saw blade Ø 225 mm

REMS Turbo K – the most powerful in its class.
Progressive drive, e.g. 2" steel pipe in only 5 s.
Easy to transport.

Design

Compact, robust, job site-proven. Small in size, handy, portable, complete only 22 kg. Automatic cooling lubricant unit. Easy sawing through favourable leverage effect. Fast saw blade change. Precise sawing. For workbench, stand or wheel stand as an accessory, for easy transport, optimum working height and stable positioning.

Universal vice

Robust, easy-running universal vice with strong clamping spindle and large clamping lever for effortless, secure clamping of the material. Standard with clamp insert for thin-walled pipes. Quick setting of bevel angle thanks to clearly laid out scale and clamping lever. Simple, sturdy length stop.

Drive

Robust, maintenance-free gear, precisely mounted in roller and needle bearings. Proven universal motor, 1200 W. Extremely strong and powerful, e.g. 2" steel pipe in only 5 s. Ideal speed 115 rpm for fast and smooth sawing.

REMS saw blades

Top German quality. REMS universal circular saw blade HSS 225×2×32 for metal, 120 teeth, adjusted to the efficiency of REMS Turbo K. Specially toothed, hardened and ground. For easy and exact sawing. REMS universal circular saw blade HSS 225×2×32, 220 teeth, adjusted for sawing stainless steel. Specially fine-toothed, hardened and ground. For an even better durability, REMS universal circular saw blade HSS-E (cobalt alloyed) 225×2×32, 220 teeth. Specially fine-toothed, hardened and ground.

Kühlschmierstoffe

REMS Sanitol and REMS Spezial (page 47). High lubricating and cooling effect. Essential for clean cuts, long service life of saw blades and machine.



German Quality Product



Supply format

REMS Turbo K Basic. Universal circular metal sawing machine with automatic cooling lubricant unit. For straight cuts and bevel cuts up to 45°. For REMS saw blade Ø 225 mm. Maintenance-free gear. Proven, powerful universal motor 230 V or 110 V, 50–60 Hz, 1200 W. Safety tip switch, saw blade protection cover, length stop. Clamp insert for thin-walled pipes. Speed 115 rpm. Ring spanner. Hexagon key. 1 filling of cooling lubricant REMS Spezial. Without saw blade. For workbench, stand or wheel stand. In a carton.

	Art.-No.
	849007

Other voltages on request.

Accessories

Description	Art.-No.
REMS universal circular saw blade HSS for metal, 225×2×32, 120 teeth	849700
REMS circular saw blade HSS for metal, fine-toothed, 225×2×32, 220 teeth	849703
REMS circular saw blade HSS-E (cobalt alloyed) for metal, fine-toothed, 225×2×32, 220 teeth. Very long service life.	849706
Electronic speed regulator for hard-to-machine materials, e.g. stainless steel pipes, hard cast iron pipes. Fixed, optimum speed.	565051
Cooling lubricants see page 47.	
Stand	849315
Wheel stand	849310

REMS Jumbo, folding workbenches, see page 93.

REMS Herkules, material supports, see page 94.











Made in Germany

REMS

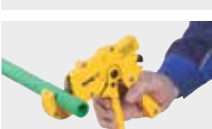
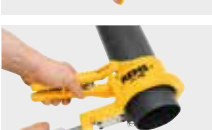
Cutting Chamfering Deburring

	Pipe and tubing cutters	68
	Cutter wheels	72
	Electric pipe cutter/ Battery-powered pipe cutter	74
	Pipe cutting machines	76
	Cordless pipe shears	80
	Pipe shears	81
	Pipe cutting and pipe chamfering tools	83
	Pipe deburrers	85

REMS RAS St

Pipe cutters

Robust quality tools for cutting pipes.
Meets high demands and long service life.

Steel pipes \varnothing 1/8–4", \varnothing 10–115 mm

REMS cutter wheels for other makes see page 72.

REMS RAS St – quality pipe cutters.

Solid body in forged steel.

Robust spindle, long spindle guidance and hardened back pressure rollers provide exact alignment to the pipe and a long service life.

Ergonomic, wide handle provides a powerful in-feed of spindle.

Broad, precise cutter wheel bearing on a hardened, non rotating wheel shaft guarantees a right angle cut.

Specially hardened cutter wheel in approved, tough-hard REMS die-steel quality ensures a long service life.

Cutter wheel protected against touching the back pressure rollers by in-feed limitation.

Only 1 cutter wheel for pipes \varnothing 1/8–4" (10–115 mm), wall thickness $s \leq 8$ mm, suitable for both pipe cutters. Cutter wheel for pipes \varnothing 1–4" to wall thickness $s \leq 12.5$ mm available as accessory.

Supply format

REMS RAS St. Pipe cutter for steel pipes. With cutter wheel. In a carton.

Description	Pipes \varnothing mm/inch	Wall thickness $s \leq$ mm	Art.-No.
St 1/8–2"	1/8–2" 10–60	8	113000
St 1 1/4–4"	1 1/4–4" 30–115	8	113100

Accessories

Description	$s \leq$ mm	Art.-No.
REMS cutter wheel St 1/8–4", s 8 for REMS RAS St 1/8–2" and St 1 1/4–4"	8	341614
REMS cutter wheel St 1–4", s 12 for REMS RAS St 1 1/4–4"	12.5	381622



German Quality Products



REMS RAS Cu-INOX

Tubing cutters

Robust quality tools for cutting tubes.
Particularly suited for cutting stainless steel tubes.

Copper tubes, thin-walled stainless steel tubes, thin-walled steel, aluminium, brass tubes \varnothing 3–120 mm \varnothing 1/8–4"

REMS cutter wheels for other makes see page 72.

REMS RAS Cu-INOX – for places with difficult access.

Small, handy, specially for use in restricted spaces.

Robust design and hardened back pressure rollers provide exact alignment to the tube and a long service life.

Large operating knob in metal for easy in-feed and cutting.

Broad, precise cutter wheel bearing on a hardened, non rotating wheel shaft guarantees a right angle cut.

Specially hardened cutter wheel in approved, tough-hard REMS die-steel quality ensures a long service life. Fast changing of cutter wheel without tools by cutter wheel axle with ball catch. Cutter wheel protected against touching the back pressure rollers by in-feed limitation.

REMS RAS Cu-INOX 3–28 S Mini with needle bearing cutter wheel and needle bearing counter-pressure rollers for very easy cutting.

Supply format

REMS RAS Cu-INOX. Tubing cutter for copper tubes, thin-walled stainless steel tubes, thin-walled steel, aluminium, brass tubes. With cutter wheel. In blister pack.

Description	Pipes \varnothing mm/inch	Wall thickness $s \leq$ mm	Art.-No.
Cu-INOX 3–16	3–16 1/8–5/8"	4	113200
Cu-INOX 3–28 Mini	3–28 1/8–1 1/8"	4	113240
Cu-INOX 3–28 S Mini, on needle bearings	3–28 1/8–1 1/8"	4	113241



REMS RAS Cu-INOX – the compact version with telescopic spindle.

Telescopic spindle. Easy, quick adjustment in both directions.

Compact design for tough use.

Sturdy telescopic spindle, long spindle guidance and 4 specially hardened back pressure rollers ensure exact alignment to the tube, easy in-feed, easy cutting and precise, right angle cut.

Ergonomic, handy operating knob in metal for easy work and long service life.

Specially hardened cutter wheel in approved, tough-hard REMS die-steel quality ensures a long service life. Fast changing of cutter wheel without tools by cutter wheel axle with ball catch. Cutter wheel protected against touching the back pressure rollers by in-feed limitation.

REMS RAS Cu-INOX 3–35 S with needle bearing cutting wheel and needle bearing counter-pressure rollers for very easy cutting.

Integrated pipe deburring device, on rotating bearing, adapts to the workpiece edge to be deburred.

Specially hardened and ground universal deburring blade guarantees easy deburring and extremely long life.

Fast, simple blade change.



Supply format

REMS RAS Cu-INOX. Pipe cutting machine for copper pipes, thin-walled stainless steel pipes, thin-walled steel-aluminium pipes, brass pipes, with integrated pipe deburring device. With cutter wheel. In blister pack.

Description	Pipes Ø mm/inch	Wall thickness s ≤ mm	Art.-No.
Cu-INOX 3–35	3–35 1/8–1 1/8"	4	113350
Cu-INOX 3–35 S, on needle bearings	3–35 1/8–1 1/8"	4	113351
Cu-INOX 3–42	3–42 1/8–1 3/4"	4	113330

REMS RAS Cu-INOX – quality pipe cutter.

Robust, solid design for heavy-duty application.

Sturdy spindle, long spindle guidance and hardened back pressure rollers provide exact alignment to the tube, easy in-feed, easy cutting and precise, right angle cut.

Ergonomic, handy operating knob in metal for easy work and long service life.

Specially hardened cutter wheel in approved, tough-hard REMS die-steel quality ensures a long service life.

Cutter wheel protected against touching the back pressure rollers by in-feed limitation.

REMS RAS Cu-INOX 8–64 S with needle bearing cutting wheel and needle bearing counter-pressure rollers for very easy cutting. Quick adjustment of the engagement spindle in both directions.

Only 1 cutter wheel for the complete working capacity Ø 3–120 mm.

Supply format

REMS RAS Cu-INOX. Tubing cutter for copper tubes, thin-walled stainless steel tubes, thin-walled steel, aluminium, brass tubes. With cutter wheel. In blister pack/in box.

Description	Pipes Ø mm/inch	Wall thickness s ≤ mm	Art.-No.
Cu-INOX 3–28	3–28 1/8–1 1/8"	4	113300
Cu-INOX 6–42	6–42 1/4–1 5/8"	4	113380
Cu-INOX 6–64	6–64 1/4–2 1/2"	4	113400
Cu-INOX 8–64 S, on needle bearings, with quick adjustment	8–64 3/8–2 1/2"	4	113401
Cu-INOX 64–120	64–120 2 1/2–4"	4	113500

Accessories

Description	Wall thickness s ≤ mm	Art.-No.
REMS cutter wheel Cu-INOX 3–120, s 4	4	113210
REMS cutter wheel Cu-INOX 3–120 S, s 4, on needle bearings	4	113213
Universal deburring blade, ground		113360



International Design Award



German Quality Products



Robust quality tools for cutting tubes.

Copper tubes \varnothing 3–64 mm
 \varnothing 1/8–2 1/2"

REMS cutter wheels for other makes see page 72.

REMS RAS Cu – the compact version with telescopic spindle.

Telescopic spindle. Easy, quick adjustment in both directions.

Compact design for tough use.

Sturdy telescopic spindle, long spindle guidance and 4 specially hardened back pressure rollers ensure exact alignment to the tube, easy in-feed, easy cutting and precise, right angle cut.

Ergonomic, handy operating knob in metal for easy work and long service life.

Specially hardened cutter wheel in approved, tough-hard REMS die-steel quality ensures a long service life. Fast changing of cutter wheel without tools by cutter wheel axle with ball catch. Cutter wheel protected against touching the back pressure rollers by in-feed limitation.

Integrated pipe deburring device, on rotating bearing, adapts to the workpiece edge to be deburred.

Specially hardened and ground universal deburring blade guarantees easy deburring and extremely long life.

Fast, simple blade change.



Supply format

REMS RAS Cu. Tubing cutter for copper tubes, with integrated pipe deburring device. With cutter wheel. In blister pack.

Description	Pipes \varnothing mm/inch	Wall thickness s ≤ mm	Art.-No.
Cu 3–35	3–35 1/8–1 1/8"	3	113340
Cu 3–42	3–42 1/8–1 1/4"	3	113320



REMS RAS Cu – quality pipe cutter. With quick adjustment.

Solid, handy, U-shaped design.

Sturdy spindle, long spindle guidance and hardened back pressure rollers provide exact alignment to the pipe, easy in-feed, easy cutting and precise, right angle cut.

Ergonomic, handy operating knob in metal for easy work and long service life.

Ratchet for quick adjustment in both directions.

Specially hardened cutter wheel in approved, tough-hard REMS die-steel quality ensures a long service life.

Cutter wheel protected against touching the back pressure rollers by in-feed limitation.

Only 1 cutter wheel for the complete working capacity \varnothing 3–120 mm.

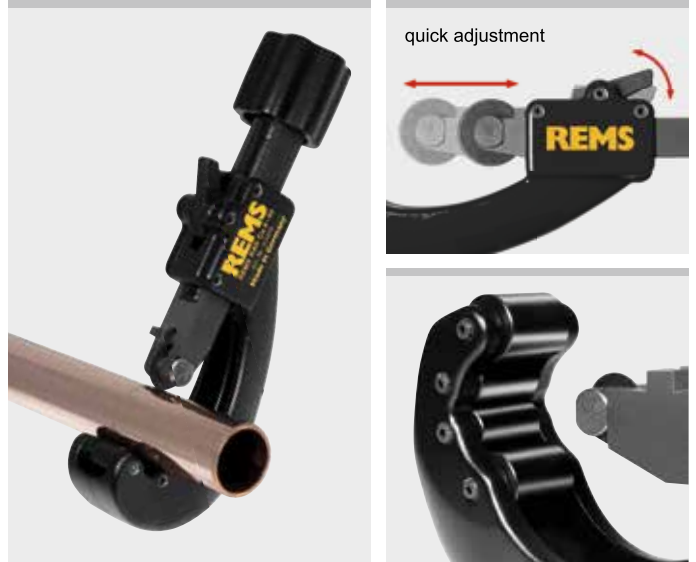

German Quality Products

Supply format

REMS RAS Cu. Tubing cutter for copper tubes. With cutter wheel. In blister pack/in box.

Description	Pipes \varnothing mm/inch	Wall thickness s ≤ mm	Art.-No.
Cu 8–42 with quick adjustment	8–42 3/8–1 5/8"	3	113370
Cu 8–64 with quick adjustment	8–64 3/8–2 1/2"	3	113410



International Design Award

Accessories

Description	Wall thickness s ≤ mm	Art.-No.
REMS cutter wheel Cu 3–120, s 3	3	113225
Universal deburring blade, ground		113360



High performance quality tools for cutting pipes.
With quick adjustment.

Plastic pipes,
multi-layer composite tubes \varnothing 10–315 mm
 \varnothing ½–12"

REMS cutter wheels for other makes see page 72.

REMS RAS P – quality pipe cutter. With quick adjustment.

Solid, handy, U-shaped design.

Sturdy spindle, long spindle guidance and hardened back pressure rollers provide exact alignment to the pipe, easy in-feed, easy cutting and precise, right angle cut.

Ergonomic, handy operating knob in metal for easy work and long service life.

Ratchet for quick adjustment in both directions.

Specially hardened cutter wheel in approved, tough-hard REMS die-steel quality ensures a long service life.

Cutter wheel protected against touching the back pressure rollers by in-feed limitation.

Cutter wheels for different wall thicknesses (s).

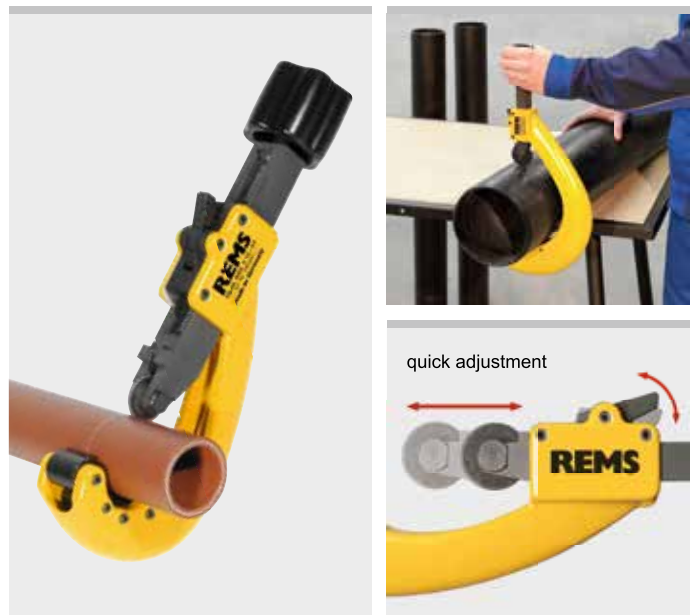

German Quality Products



Supply format

REMS RAS P. Pipe cutter for plastic pipes and multi-layer composite tubes.
With cutter wheel. In blister pack/in box.

Description	Pipes \varnothing mm/inch	Wall thickness s ≤ mm	Art.-No.
P 10–40 with quick adjustment	10–40 ½–1½"	7	290050
P 10–63 with quick adjustment	10–63 ½–2"	7	290000
P 50–110 with quick adjustment	50–110 2–4"	11	290100
P 110–160 with quick adjustment	110–160 4–6"	16	290200

REMS RAS P – cutting up to \varnothing 315 mm, s ≤ 19 mm.

Fast and inexpensive cutting of large pipes. Quick adjustment.
Separate pipe centering for right angle cutting.

Solid design, double-T-shaped body.

Cutter wheels for different wall thicknesses (s).

Supply format

REMS RAS P. Pipe cutter for plastic pipes and multi-layer composite tubes.
With cutter wheel and spare cutter wheel. In sturdy case.

Description	Pipes \varnothing mm/inch	Wall thickness s ≤ mm	Art.-No.
P 180–315 with quick adjustment	180–315 7–12"	16	290300

Accessories

Description	s ≤ mm	Art.-No.
REMS cutter wheel P 10–63, s 7 for REMS RAS P 10–40, 10–63	7	290016
REMS cutter wheel P 50–315, s 11 for REMS RAS P 50–110, 110–160, 180–315	11	290116
REMS cutter wheel P 50–315, s 16 for REMS RAS P 50–110, 110–160, 180–315	16	290216
REMS cutter wheel P 50–315, s 19 for REMS RAS P 50–110, 110–160, 180–315	19	290316



REMS cutter wheels

German Quality Products
For REMS pipe and tubing cutters and other makes*

Steel pipes		
REMS cutter wheel St 1/4-4", s 8		
Wall thickness s ≤ 8 mm	Art.-No.	
to fit following pipe cutters	Capacity	Description
REMS	1/4-2" 1/4-4"	RAS St 1/4-2" RAS St 1/4-4"
Alarm	1/4-2" 1/4-4"	10002 10004
Brinko	1/4-2"	629
Dako	1/4-2"	9.220
Format	1/4-2"	F3061900
Mast	1/4-2" 1/4-4"	52/2 52/4
Reed	1/4-2"	03320
Ridgid	1/4-2"	2-A
ROLLER	1/4-2" 1/4-4"	Corso St 1/4-2" Corso St 1/4-4"
Rothenberger	1/4-2"	7.0045
Stahlwille	1/4-2" 1/4-4"	150/2 150/4
SuperEgo	1/4-2"	701
VBW	1/4-2" 1/4-4"	140005 140010
Virax	1/2-2"	210120 (2101250)
REMS cutter wheel St 1-4", s 12		
Wall thickness s ≤ 12,5 mm	Art.-No.	
to fit following pipe cutters	Capacity	Description
REMS	1/4-4"	RAS St 1/4-4"
Alarm	1/4-4"	10004
Mast	1/4-4"	52/4
Reed	1-3"	03325
ROLLER	1/4-4"	Corso St 1/4-4"
Stahlwille	1/4-4"	150/4
VBW	1/4-4"	140010

Plastic pipes, composite tubes		
REMS cutter wheel P 10-63, s 7		
Wall thickness s ≤ 7 mm	Art.-No.	
to fit following pipe cutters	Capacity	Description
REMS	10-40 10-63	RAS P 10-40 RAS P 10-63
ROLLER	10-40 10-63	Corso P 10-40 Corso P 10-63
REMS cutter wheel P 50-315, s 11		
Wall thickness s ≤ 11 mm	290116	
REMS cutter wheel P 50-315, s 16		
Wall thickness s ≤ 16 mm	290216	
REMS cutter wheel P 50-315, s 19		
Wall thickness s ≤ 19 mm	290316	
to fit following pipe cutters	Capacity	Description
REMS	50-110 110-160 180-315	RAS P 50-110 RAS P 110-160 RAS P 180-315
Reed	48-114	TC 4 Q (only Art.-No. 290116)
Ridgid	50-110 110-160	154 156
ROLLER	50-110 110-160	Corso P 50-110 Corso P 110-160
Rothenberger	50-125 100-168	7.0032 7.0033
SuperEgo	50-125 100-168	737 738
Virax	12-63	210620 (2106063)

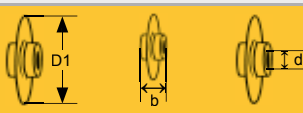
Dimensions to REMS cutter wheels				
				
REMS cutter wheel	Art.-No.	Ø D1 mm	b mm	Ø d mm
St 1/4-4", s 8	341614	31.92	18.94	9.07
St 1-4", s 12	381622	40.92	18.94	9.07
Cu-INOX 3-120, s 4	113210	19.50	4.93	5.02
Cu-INOX 3-120 S, s 4	113213	19.50	4.93	5.02
Cu-INOX b 3, s 4	113220	18.50	3.04	4.82
Cu 3-120, s 3	113225	18.50	4.93	5.02
P 10-63, s 7	290016	25.00	5.94	6.02
P 50-315, s 11	290116	35.00	10.92	8.03
P 50-315, s 16	290216	45.00	10.92	8.03
P 50-315, s 19	290316	51.00	10.92	8.03

Copper tubes, stainless steel tubes			
REMS cutter wheel Cu-INOX 3-120, s 4			
Wall thickness s ≤ 4 mm	Art.-No.		
to fit following pipe cutters	Capacity	Description	
REMS	3-16 3-28 3-35 3-42 6-42 6-64 64-120 3-35 3-42	RAS Cu-INOX RAS Cu-INOX RAS Cu-INOX RAS Cu-INOX RAS Cu-INOX RAS Cu-INOX RAS Cu-INOX RAS Cu RAS Cu	3-16 3-28 3-35 3-42 6-42 6-64 64-120 3-35 3-42
Alarm	3-16 3-35	10030 10025	
Brinko	3-35	632	
Dako	4-16	231	
Mast	3-16 3-35	C 16 C 35	
ROLLER	3-16 3-28 3-35 6-42 6-64 64-120 3-35	Corso Cu-INOX Corso Cu-INOX Corso Cu-INOX Corso Cu-INOX Corso Cu-INOX Corso Cu-INOX Corso Cu	3-16 3-28 3-35 6-42 6-64 64-120 3-35
Sturem	3-16 3-35 3-35	141600 123500 133500	
VBW	3-16 3-36	143005 141005	

REMS cutter wheel Cu-INOX 3-120 S, s 4, on needle bearings			
Wall thickness s ≤ 4 mm	Art.-No.		
to fit following pipe cutters	Capacity	Description	
REMS	3-35 8-64	RAS Cu-INOX RAS Cu-INOX	3-35 S 8-64 S
ROLLER	3-35 8-64	Corso Cu-INOX Corso Cu-INOX	3-35 S 8-64 S

REMS cutter wheel Cu-INOX b 3, s 4			
Wall thickness s ≤ 4 mm	Art.-No.		
to fit following pipe cutters	Capacity	Description	
Ridgid	3-16 3-28 6-28 6-60	103 150 101 205	
Rothenberger	3-30 6-22	7.0019 7.0002	
SuperEgo	3-16 3-30	716 725	
VBW	6-28	142005	
Virax	4-16 6-28 6-28	210310 (2103016) 210320 (2103100) 210300 (2103228)	

Copper tubes			
REMS cutter wheel Cu 3-120, s 3			
Wall thickness s ≤ 3 mm	Art.-No.		
to fit following pipe cutters	Capacity	Description	
REMS	3-16 3-28 3-35 3-42 6-42 6-64 64-120 3-35 3-42 8-42 8-64	RAS Cu-INOX RAS Cu-INOX RAS Cu-INOX RAS Cu-INOX RAS Cu-INOX RAS Cu-INOX RAS Cu-INOX RAS Cu RAS Cu RAS Cu RAS Cu	3-16 3-28 3-35 3-42 6-42 6-64 64-120 3-35 3-42 8-42 8-64
Alarm	3-16 3-35	10030 10025	
Brinko	3-35	632	
Dako	4-16	231	
Mast	3-16 3-35	C 16 C 35	
ROLLER	3-16 3-28 3-35 6-42 6-64 64-120 3-35 8-42 8-64	Corso Cu-INOX Corso Cu-INOX Corso Cu-INOX Corso Cu-INOX Corso Cu-INOX Corso Cu-INOX Corso Cu Corso Cu Corso Cu	3-16 3-28 3-35 6-42 6-64 64-120 3-35 8-42 8-64
Sturem	3-16 3-35 3-35	141600 123500 133500	
VBW	3-16 3-36	143005 141005	



REMS Nano

Electric pipe and tubing cutter

Powerful, handy electric tool for cutting pipe and tubing. For trade and industry. For the building site and the workshop.

Stainless steel pipes of pressfitting systems, carbon steel, copper	Ø 12–28 mm Ø 10–35 mm
Multilayer composite pipes	Ø 10–40 mm

REMS Nano – cutting up to Ø 40 mm. Ultra-light. Fast. Right angled. Chip-free. Without outer burr. Dry.

Ideal for pressfitting systems

Right angled cutting, according to requirements

Chip-free, no chips in piping system

No outer burr, no damage to O-ring by outer burr

Dry cutting, no damage to O-rings from lubricants

Fast, prevents degradation of pipe material through overheating.

Design

Mobile, electric pipe cutting machine for fast, right angled cutting without outer burr. Handy and light, only 1.9 kg. Also for fixing to the workbench or in the vice. Strong, torsion-free aluminium structure for right angled cutting. Easy cutting of the pipes by specially designed cutter wheel. Powered cutter wheel for fast cutting. Energy-saving in-feed due to ergonomically designed pressing lever. Cutter wheel protected against touching the back pressure rollers by in-feed limitation.

Pipe support

3 sturdy, specially arranged counter-pressure rollers made of hardened precision steel for low-friction turning and safe guidance of the pipes to be cut in the whole working range Ø 10–40 mm and for optimisation of the contact points of the cutting wheel on the pipe to be cut (Patent EP 2 077 175). No setting.

Drive

Robust gear precisely mounted in ball and needle bearings, maintenance-free. Proven DC motor 230 V, 130 W. Powerful. e.g. copper pipe Ø 22 mm in only 3 s. Ideal speed 130 rpm for optimum cutting speed of the pipes. Safety switch.

REMS cutter wheels

Top German quality. Cutter wheels specially designed to the performance capability of the REMS Nano and for numerous pipe materials with variable cutting geometries for fast cutting with no outer burr. Specially hardened, from proven, through-hardened REMS die-steel, ensuring long service life.



German Quality Product

Tested by electrosuisse >>

Supply format

REMS Nano Basic-Pack. Electric pipe cutting machine for fast, right angled cutting of pipes Ø 10–40 mm, without outer burr. For pipes of the press fitting systems made of stainless steel, carbon steel, Ø 12–28 mm, copper Ø 10–35 mm. Multilayer composite tubes Ø 10–40 mm. With maintenance-free gear, proven DC motor 130 V, 50–60 Hz, 200 W. Speed 130 rpm. Back pressure rollers made of hardened precision steel. Safety switch. Single open ended wrench size 8. Without cutter wheel. In carrying bag.

	Art.-No.	
	844010	



Accessories

Description	Art.-No.	
REMS cutter wheel Cu-INOX for stainless steel pipes of pressfitting systems, copper, carbon steel	844050	
REMS cutter wheel V for multilayer composite pipes	844051	
Carrying bag	574436	
REMS Jumbo , folding workbenches, see page 93.		
REMS Herkules , material supports, see page 94.		

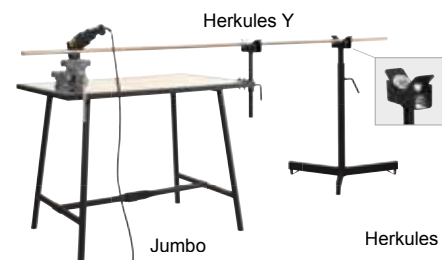

REMS Akku-Nano

Cordless pipe cutter

Powerful, handy electric tool for cutting pipe and tubing. For trade and industry. For the building site and the workshop.

Stainless steel pipes of pressfitting systems, carbon steel, copper	Ø 12–28 mm Ø 10–35 mm
Multilayer composite pipes	Ø 10–40 mm

REMS Akku-Nano – cutting up to Ø 40 mm. Ultra-light. Fast. Right angled. Chip-free. Without outer burr. Dry.

Ideal for pressfitting systems

Right angled cutting, according to requirements

Chip-free, no chips in piping system

No outer burr, no damage to O-ring by outer burr

Dry cutting, no damage to O-rings from lubricants

Fast, prevents degradation of pipe material through overheating.

Design

Mobile, battery-powered pipe cutting machine for fast, right angled cutting without outer burr. Handy and light, only 2.1 kg. Also for fixing to the workbench or in the vice. Strong, torsion-free aluminium structure for right angled cutting. Easy cutting of the pipes by specially designed cutter wheel. Powered cutter wheel for fast cutting. Energy-saving in-feed due to ergonomically designed pressing lever. Cutter wheel protected against touching the back pressure rollers by in-feed limitation. Electronic charging status check with low discharge protection.

Pipe support

3 sturdy, specially arranged counter-pressure rollers made of hardened precision steel for low-friction turning and safe guidance of the pipes to be cut in the whole working range Ø 10–40 mm and for optimisation of the contact points of the cutting wheel on the pipe to be cut (Patent EP 2 077 175). No setting.

Drive

Robust, precision ball and needle bearing gears, maintenance-free. Powerful battery motor 10.8 V, with large power reserve, 270 W output. Super fast, e.g. copper pipe Ø 22 mm in just 3 s. Ideal speed 130 rpm for optimum cutting speed of the pipes. Safety switch.

Li-Ion technology

Battery Li-Ion 10.8 with 1.3 Ah capacity. Powerful and light. High energy density for many cuts. Overheating and overloading protection by temperature monitor (NTC). Rapid charger for short charging times. No memory effect for maximum battery performance.

REMS cutter wheels

Top German quality. Cutter wheels specially designed to the performance capability of the REMS Akku-Nano and for numerous pipe materials with variable cutting geometries for fast cutting with no outer burr. Specially hardened, from proven, through-hardened REMS die-steel, ensuring long service life.

Supply format

REMS Akku-Nano Basic-Pack. Electric pipe cutting machine for fast, right angled cutting of pipes Ø 10–40 mm, without outer burr. For pipes of the press fitting systems made of stainless steel, carbon steel, Ø 12–28 mm, copper Ø 10–35 mm. Multilayer composite tubes Ø 10–40 mm. With maintenance-free gear, powerful battery motor 10.8 V, 270 W. Speed 130 rpm. Safety switch. Battery Li-Ion 10.8 V, 1.3 Ah, rapid charger Li-Ion 230 V, 50–60 Hz, 65 W. Counter pressures rollers made of hardened precision steel. Single open ended wrench size 8. Without cutting wheel. In carrying bag.

	Art.-No.	
	844011	

Accessories

Description	Art.-No.
REMS cutter wheel Cu-INOX for stainless steel pipes of pressfitting systems, copper, carbon steel	844050
REMS cutter wheel V for multilayer composite pipes	844051
Battery Li-Ion 10.8 V, 1.3 Ah	844510
Rapid charger Li-Ion/Ni-Cd 230 V, 50–60 Hz, 65 W	571560
Carrying bag	574436
REMS Jumbo , folding workbenches, see page 93.	
REMS Herkules , material supports, see page 94.	



German Quality Product

Tested by electrosuisse >>>



Light, portable compact machine. Universal for cutting and deburring pipes. For trade and industry. For the building site and the workshop.

Stainless steel pipes of pressfitting systems, carbon steel, copper	Ø 8–108 mm
Steel pipes EN 10255 (DIN 2440)	DN 10–100 Ø ¼–4", Ø 14–115 mm
Cast iron pipes (SML) EN 877 (DIN 19522)	DN 50–100
Plastic pipes SDR 11	
Wall thickness $s \leq 10$ mm	Ø 10–110 mm
Multilayer composite pipes	Ø 10–110 mm
REMS Cento RF Set	
Welded drain pipe/down pipe made of stainless steel (EN 1124)	Ø 40–110 mm

REMS Cento – Cutting and deburring up to Ø 115 mm. Super fast. Right angled. Chip-free. No outer burr. Dry cutting.

Universal for many pipe types.

Ideal for pressfitting systems

Right angled cutting, according to requirements

Chip-free, no chips in piping system

No outer burr, no damage to O-ring by outer burr

Dry, no damage to the O-ring by coolants-lubricants.

Fast, prevents degradation of pipe material through overheating.

Design

Compact, mobile pipe cutting machine for fast, right angled, cutting with no outer burr. Handy and light, only 16.8 kg. Stable, distortion-free cast construction for right angled cutting. Easy pipe-cutting through specially designed cutter wheel. Powered cutter wheel and linear advance for fast cutting (**Patent EP 1 782 904**). Power saving feed-in through easy to grip, proven advance-lever and needle bearing mounted machine screw spindle. Cutter wheel protected – as movement restricted to before any contact with the rollers. Connection for driving outer/inner pipe deburrer REMS REG 10–54 E. For workbench, stand or wheel stand as an accessory, for easy transport, optimum working height and stable positioning. An alternative feed lever is available for operating the drive unit on the floor, see accessories.

Running rollers

REMS Cento with 4 strong hardened precision tubular steel running rollers on ball bearings for low-friction turning of the pipes to be cut Ø 22–115 mm, Ø ¼–4", trapezoidally arranged, replaceable. No setting work required in the whole working range Ø 22–115 mm. Stainless tubular steel rollers as accessory. Cutting of pipes Ø 8–22 mm by placing two pipe sections Ø 28 × 220 mm on the running rollers. REMS Cento RF with 4 strong, ball bearing mounted rollers for low-friction rotation of the welded drain pipes/down pipes made of stainless steel to be cut (EN 1124) Ø 40–110 mm, made of polyamide, to avoid damage to the pipe surfaces, with Ø 75 and 110 mm pipe guides.

Drive

Robust gear, precisely mounted in roller and needle bearings, maintenance-free. Proven universal motor, 1200 W. Powerful, e.g. stainless steel pipe Ø 54 mm in just 4 s. Ideal speed 115 rpm for optimum cutting speed of the pipes. Safety foot-switch with emergency stop.

REMS cutter wheels

Top German quality. Cutter wheels specially designed to the performance capability of the REMS Cento and for numerous pipe materials with variable cutting geometries for fast cutting with no outer burr. Specially hardened, from proven, through-hardened REMS die-steel, ensuring long service life.

REMS pipe deburrer

Inner pipe deburrer REMS REG 28–108 for pipes Ø 28–108 mm, Ø ¼–4", for electric drive with the REMS Cento pipe cutting machine, as an accessory. Outer/inner pipe deburrer REMS REG 10–54 E for pipes Ø 10–54 mm, Ø ½–2½", for electric drive with the REMS Cento pipe cutting machine, see page 87.

Patent EP 1 782 904



Tested by electrosuisse >>>

German Quality Product

Supply format

REMS Cento Basic. Pipe cutting machine for fast, right angled, cutting of pipes with no outer burr Ø 8–115 mm. For pipes of the press fitting systems made from stainless steel, carbon steel, copper, Ø 8–108 mm. For steel pipes EN 10255 (DIN 2440) DN 10–100, Ø ¼–4", Ø 14–115 mm, cast pipes (SML) EN 877 (DIN 19522) DN 50–100, plastic tubes SDR 11, wall thickness $s \leq 10$ mm, Ø 10–110 mm, composite tubes Ø 10–110 mm. With maintenance-free gear, proven universal motor 230 V or 110 V, 50–60 Hz, 1200 W. Speed 115 rpm. Rollers in hardened precision steel pipe for pipes Ø 22–115 mm, Ø ¾–4". Safety foot-switch. Ring spanner. Without cutter wheel. For workbench, stand or wheel stand. In a carton.

	Art.-No.	
	845001	

Other voltages on request.



Supply format

REMS Cento RF Set. Pipe cutting machine especially for fast, right-angled cutting of welded drain pipes/down pipes made of stainless steel (EN 1124) Ø 40–110 mm. As Art. No. 845001, but with rollers made of polyamide and pipe guides Ø 75 and 110 mm. Safety foot switch. Ring spanner. With cutting wheel RF. For workbench, stand or wheel stand. In a carton.

	Art.-No.	
	845003	

Other voltages on request.



Accessories

Description	Art.-No.	
Feed lever for operating the drive unit on the floor (for drive units manufactured from 2014 onwards).	845218	
REMS cutter wheel Cu-INOX for stainless steel pipes of pressfitting systems, copper, carbon steel	845050	
REMS cutter wheel Cu specially for pipes of copper pressfitting systems	845053	
REMS cutter wheel St for steel pipes, cast iron pipes (SML)	845052	
REMS cutter wheel V for plastic and multilayer composite pipes, wall thickness $s \leq 10$ mm	845051	
REMS cutting wheel C-SF especially for pipes of the pressfitting systems and push fitting systems made from carbon steel, simultaneously produces a chamfer.	845055	
REMS cutting wheel RF for cutting welded drain pipes/down pipes made of stainless steel (EN 1124) with REMS Cento RF.	845054	
Hardened, precision tubular steel rollers (pack of 4)	845118	
Stainless tubular steel INOX rollers (pack of 4)	845110	
REMS REG 10–54 E , outer/inner pipe deburrer, see page 87		
REMS REG 28–108 , inner pipe deburrer for pipes Ø 28–108 mm, Ø ¼–4", for electric drive with the REMS Cento pipe cutting machine (with REMS cutting wheel Art. No. 845050 or 845053).	113840	
Stand	849315	
Wheel stand	849310	
REMS Jumbo , folding workbenches, see page 93.		
REMS Herkules , material supports, see page 94.		

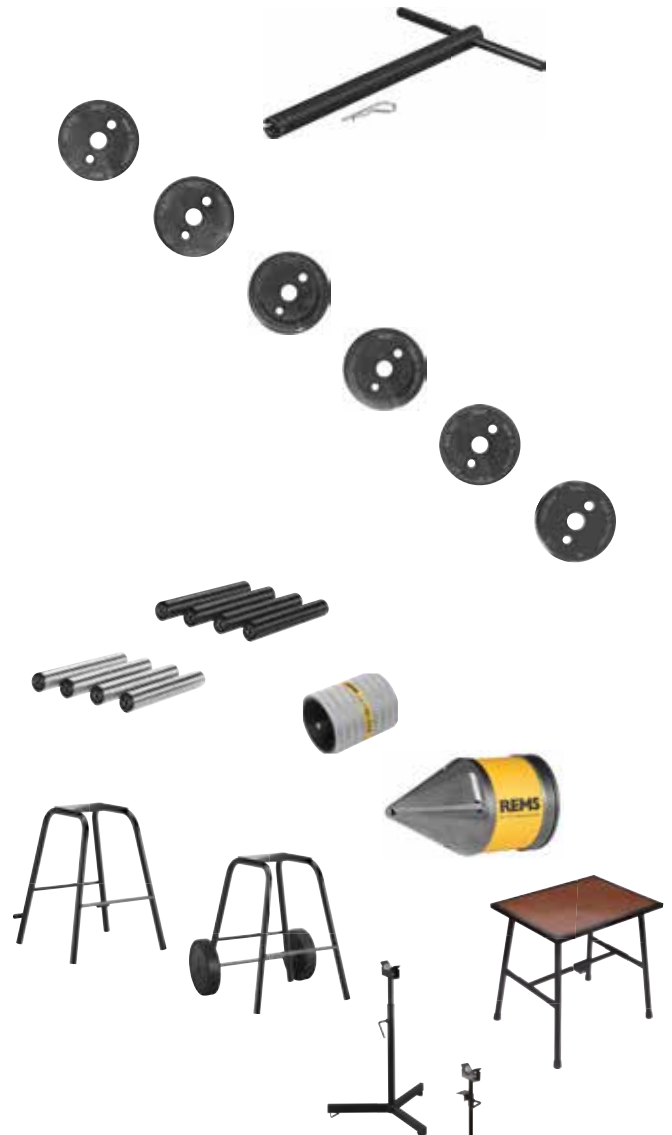

Robust, mobile compact machine. Universal for cutting pipes. For trade and industry. For the building site and the workshop.

Stainless steel pipes of pressfitting systems, carbon steel, copper	Ø 54–225 mm
Steel pipes EN 10255 (DIN 2440)	DN 10–150 Ø 2–6"
Cast iron pipes (SML) EN 877 (DIN 19522)	DN 50–200
Plastic pipes SDR 11	
Wall thickness $s \leq 21$ mm	Ø 40–225 mm
Multilayer composite pipes	Ø 40–110 mm

**REMS DueCento – Cutting up to Ø 225 mm.
Right angled. Chip-free. Ready for welding. Fast.
No outer burr. Dry cutting.**

Universal for many pipe types.

Right angled cutting, according to requirements

Chip-free, no chips in the pipe system, no dust

Weldable, for muff and butt welds

Fast, without impairment of the pipe material by overheating

Without outside burr, easy insertion into connecting muffs

Dry cutting, without impairment by coolant lubricants

Design

Compact, mobile pipe cutting machine for fast, right angled, cutting with no outer burr. Handy and easily transportable, only 37 kg. Stable, distortion-free cast construction for right angled cutting. Easy pipe-cutting through specially designed cutter wheel. Powered cutter wheel and linear advance for fast cutting (Patent DP 10 2005 053 179). Power saving feed-in through easy to grip, proven advance-lever and needle bearing mounted machine screw spindle. Cutter wheel protected – as movement restricted to before any contact with the rollers. Practical chassis with two rubber tyred wheels for easy transport.

Running rollers

4 strong hardened precision tubular steel running rollers on ball bearings for low-friction turning of the pipes Ø 100–225 mm, Ø 4–6" to be cut, trapezoidally arranged, replaceable. No setting work in the working range Ø 100–225 mm, Ø 4–6". Roller insert for cutting pipes Ø 40–100 mm, Ø 1½–3½", as an accessory.

Drive

Robust gear, precisely mounted in roller and needle bearings, maintenance-free. Proven universal motor, 1200 W. Powerful, e.g. plastic tube PE Ø 225 mm in just 15 s. Ideal speed 115 rpm for optimum cutting speed of the pipes. Safety foot-switch with emergency stop.

REMS cutter wheels

Top German quality. Cutter wheels specially designed to the performance capability of the REMS DueCento and for numerous pipe materials with variable cutting geometries for fast cutting with no outer burr. Specially hardened, from proven, through-hardened REMS die-steel, ensuring long service life.

Pipe supports

Pipe supports, height adjustable, for pipes Ø 40–100 mm, Ø 1½–3½" and Ø 100–225 mm, Ø 4–6". Easy moving of the material in all directions when turning, pulling and pushing by four stainless steel balls mounted in a rust-protected housing. Safe guiding of long pipes by use of several pipe supports.

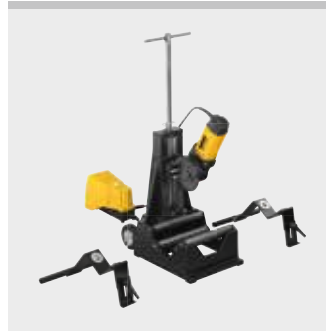

German Quality Product

Tested by electrosuisse >>

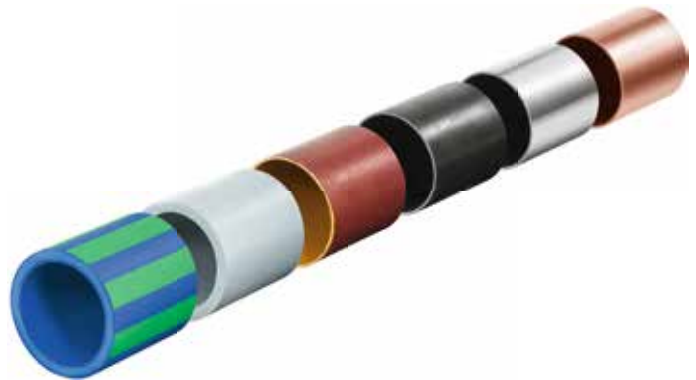

Supply format

REMS DueCento Basic. Pipe cutting machine for fast, right angled cutting of pipes \varnothing 40–225 mm, without outside burr. For pipes of the press fitting systems made from stainless steel, carbon steel, copper, \varnothing 54–225 mm. For steel pipes EN 10255 (DIN 2440) DN 50–150, \varnothing 2–6", cast pipes (SML) EN 877 (DIN 19522) DN 50–200, plastic tubes SDR 11, wall thickness $s \leq 21$ mm, \varnothing 40–225 mm, composite tubes \varnothing 40–110 mm. With maintenance-free gears, proven universal motor 110 / 230 V, 50–60 Hz, 1,200 W. Speed 115 rpm. Hardened, precision tubular steel rollers for pipes \varnothing 100–225 mm, \varnothing 4–6". Safety foot switch. Ring spanner. Without cutter wheel. Two height adjustable pipe rests \varnothing 100–225 mm, \varnothing 4–6". In a carton.

	Art.-No.	
	845004	

Other voltages on request.



Accessories

Description	Art.-No.	
REMS cutter wheel Cu-INOX for stainless steel pipes of pressfitting systems, copper, carbon steel	845050	
REMS cutter wheel Cu specially for pipes of copper pressfitting systems	845053	
REMS cutter wheel St for steel pipes, cast iron pipes (SML)	845052	
REMS cutting wheel C-SF especially for pipes of the pressfitting systems and push fitting systems made from carbon steel, simultaneously produces a chamfer.	845055	
REMS cutter wheel V, s 10 for plastic and multilayer composite pipes, wall thickness $s \leq 10$ mm	845051	
REMS cutter wheel P, s 21 for plastic and multilayer composite tubes, wall thickness $s \leq 21$ mm	845057	
Pipe support \varnothing 100–225 mm , height adjustable, for pipes \varnothing 100–225 mm, \varnothing 4–6"	845220	
Pipe support \varnothing 40–100 mm , height adjustable, for pipes \varnothing 40–100 mm, \varnothing 1½–3½"	845230	
Roller insert for cutting pipes \varnothing 40–100 mm, \varnothing 1½–3½"	845060	



REMS Akku-ROS P 40

Cordless pipe shears

Powerful, handy electric tool for fast, easy cutting of pipe and tubing. Also for thin-walled pipes. Only 1.2 kg. For one-hand operation. Ideal for assembly, disassembly, repair.

Plastic pipes, multilayer composite pipes $\varnothing \leq 40 \text{ mm}$
 $s \leq 6,7 \text{ mm}$ $\varnothing \leq 1\frac{5}{8}"$

REMS Akku-ROS P 40 – fast, easy cutting of pipes. Powerful, e.g. multilayer composite pipes $\varnothing 20 \text{ mm}$ in just 4 s.

Universal use

Specially hardened, wedge-shaped blade for universal cutting of plastic and multilayer composite pipes. Also ideal for cutting thick-walled PP and PVC pipes.

Design

Ultra light, ultra small, ultra handy. Drive machine with NiMH battery only 1.2 kg. Can therefore be used everywhere, free hand, over head, also in very confined spaces. Optimum weight distribution for one-hand operation. Sturdy housing made of glass fibre-reinforced polyamide with steel inlay, with ergonomically shaped handle. Right-angled, burr-free cut by exact pipe rest and blade guided on both sides. Automatic switch off after cutting process. Rapid return for fast resetting of the blade saves time and trouble. For effective working.

Wedge-shaped blade

Changeable, specially hardened wedge-shaped blade, also ideal for cutting thick-walled PP and PVC pipes. Chip-free cutting – no chips left in the pipe.

Drive

Powerful battery motor 9,6 V, 70 W output. Powerful, e.g. multilayer composite pipe $\varnothing 22 \text{ mm}$ in just 4 s. Robust, maintenance-free gear. Safety switch. On/Off switch.

Battery

Integrated NiMH battery 9.6 V with 1.0 Ah capacity, for many cuts. Powerful and light. High energy density. Up to 200 cuts per battery charge. Charger NiMH 100–240 V, 50–60 Hz, 6 W, for short charging times. Pulse charging technique reduces memory effect for maximum battery performance.

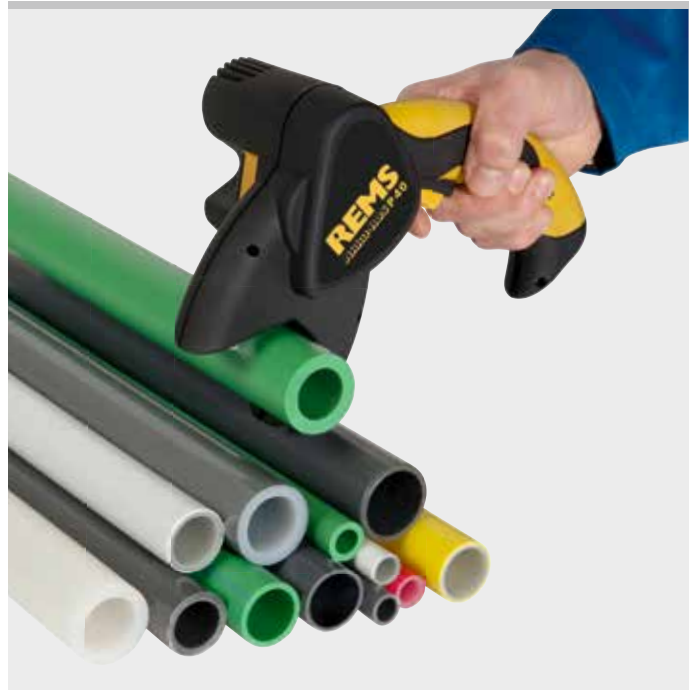

Supply format

REMS Akku-ROS P 40 Set. Cordless pipe shears for fast, easy cutting of plastic and composite pipes $\varnothing \leq 40 \text{ mm}$, $\varnothing \leq 1\frac{5}{8}"$, $s \leq 6,7 \text{ mm}$. Electric drive with powerful battery motor 9.6 V, 70 W, maintenance-free gear, safety switch, on/off switch. NiMH battery 9.6 V, 1.0 Ah, charger NiMH 100–240 V, 50–60 Hz, 6 W. With wedge-shaped blade. In box.

	Art.-No.	
	291310	

Accessories

Description	Art.-No.	
Blade for REMS Akku-ROS P 40	291301	



Handy quality tools for clean, fast pipe cuts.
For thin-walled pipes also. Sturdy aluminium design.
For single-hand operation.

Plastic pipes, multi-layer composite tubes $\varnothing \leq 63 \text{ mm}$
 $\varnothing \leq 2''$

REMS ROS P 35
REMS ROS P 35 A
REMS ROS P 42
REMS ROS P 42 PS
REMS ROS P 63 P

Sturdy aluminium design.
Replaceable, specially hardened blade.
For single-hand operation. Effortless working through power transmitting ratchet feed.
Quick reverse saves time and effort. REMS ROS P 35 A with automatic quick reverse after completion of cutting.
Right angle, burr-free cut through exact pipe support and guided blade on both sides.
Chipless cutting – no chips remaining in pipe.

Supply format

REMS ROS P. Pipe shear for plastic pipes and multi-layer composite tubes. With blade. In blister pack/in box.

Description	Pipes $\varnothing \leq \text{mm/inch}$	Art.-No.
P 35 with quick reverse	35 1 3/8"	291200
P 35 A with automatic quick reverse	35 1 3/8"	291220
P 42 with quick reverse	42 1 5/8"	291250
P 42 PS with quick reverse	42 1 5/8"	291000
P 63 P with quick reverse	63 2"	291270

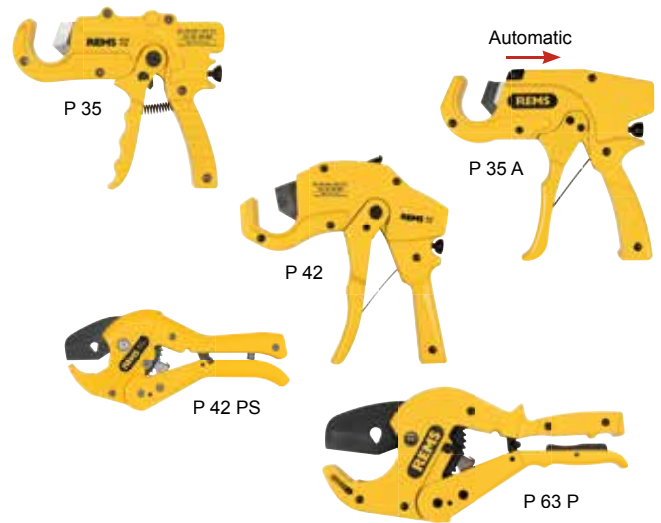

Robust quality tools for clean, fast pipe cuts.

Plastic pipes $\varnothing \leq 75 \text{ mm}$
 $\varnothing \leq 2 1/2''$

REMS ROS P 75 P

Robust steel version for rugged conditions and long life, with end stop for powerful engagement, also ideal for thick-walled plastic pipes.
Rough, non-slip handle for good grip.
Replaceable, specially hardened blade.
Fast, easy operation through guided ratchet on both sides and fine-toothed ratchet gear, specially hardened.
Right angle, burr-free cut through two-point pipe support and guided blade on both sides.
Chipless cutting – no chips remaining in pipe.



Supply format

REMS ROS P. Pipe shear for plastic pipes. With blade. In a carton.

Description	Pipes $\varnothing \leq \text{mm/inch}$	Art.-No.
P 75 P	75 2 1/2"	291101

Accessories

Description	Art.-No.
Blade for REMS ROS P 35	291201
Blade for REMS ROS P 35 A	291221
Blade for REMS ROS P 42	291251
Blade for REMS ROS P 42 PS	291023
Blade for REMS ROS P 63 P	291271
Blade for REMS ROS P 75	291111
Blade for REMS ROS P 75 P	291112



REMS Cut 110 P

Pipe cutting and pipe chamfering tool

Robust quality tool for right-angle, plain cutting and chamfering (15°) in one operation. Can be used anywhere, free-hand, on parallel vice or work bench.

Plastic pipes in
ABS, PB, PE, PE-HD, PE-X,
PP, PVC, PVDF

Ø 40–110 mm

REMS Cut 110 P – cutting and chamfering at the same time.

Robust metal design for tough use.

Cutting and chamfering in one operation. While turning the tool shaft, also cutting only possible.

Fast and easy to use, ergonomic clamping grip.

Spring loaded clamp inserts in plastic for concentric clamping of different pipe sizes. Easy to change without tools.

Steplessly adjustable clamping pressure accommodates pipe tolerances.

Cutting and chamfering tool in hard metal with optimum cutter geometry ensures precise cutting and chamfering. Long service life.

Holder for workbench for effortless operation.

Tool set Cu-INOX and clamp inserts for cutting welded rain gutter pipes in copper, titanium zinc, stainless steel, as accessory.



Supply format

REMS Cut 110 P Set. Pipe cutting and pipe chamfering tool for plastic pipes in ABS, PB, PE, PE-HD, PE-X, PP, PVC, PVDF, Ø 40–110 mm. Quick clamping device Ø 110 mm with 2 each of clamping inserts Ø 50 and 75 mm. Tool set P with cutting and chamfering blade P, s 11. In sturdy case.

Description	Art.-No.
Set 50-75-110	290400



Accessories

Description	Pipes Ø mm	Art.-No.
Clamping inserts (pack of 2)	40	290420
	50	290421
	52	290422
	56	290444
	58	290423
	60	290445
	63	290427
	75	290424
	76	290446
	78	290425
	80	290447
	87	290448
	90	290426
	100	290449
Tool set P with cutting and chamfering blade P, s 11		290432
Cutting and chamfering blade P, s 11		290430
Cutting and chamfering blade P, s 15.5		290431
Tool set Cu-INOX with cutter wheel Cu-INOX 3–120, s 4		290433
REMS cutter wheel Cu-INOX 3–120, s 4		113210
Holder for work bench		290440
Case		290437

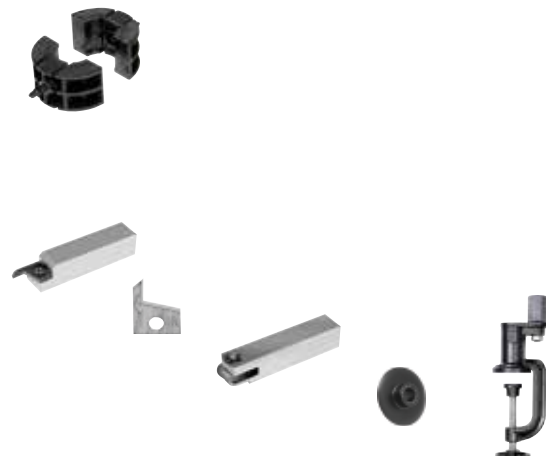

REMS Cut 110 Cu-INOX

Pipe cutting tool

Robust quality tool for right-angle cutting of welded pipe. Can be used anywhere, free-hand, on parallel vice or work bench.

Welded copper drainpipe/downpipe,
Titanium zinc, stainless steel (EN 1124) Ø 50–110 mm

REMS Cut 110 Cu-INOX – Easy cutting of downpipes.

Robust metal design for tough use.

Fast and easy to use, ergonomic clamping grip.

Spring loaded clamp inserts in plastic for concentric clamping of different pipe sizes. Easy to change without tools.

Steplessly adjustable clamping pressure accommodates pipe tolerances.

Cutting and chamfering tool in hard metal with optimum cutter geometry ensures precise cutting and chamfering. Long service life.

Holder for workbench for effortless operation.

Tool set P and clamp inserts for right-angle, plain cutting and chamfering (15°) of plastic pipe, as accessory, see page 83.



Supply format

REMS Cut 110 Cu-INOX Set. Pipe cutter for welded drainpipes/downpipes made of copper, titanium zinc, stainless steel (EN 1124), Ø 50–110 mm. Quick action clamp Ø 110 mm with clamp inserts. Tool set Cu-INOX with cutter wheel Cu-INOX 3–120, s 4. In sturdy case.

Description	Art.-No.
Set 50-75-110	290412
Set 60-80-100-110	290410
Set 76-87-100-110	290411

Accessories

Description	Art.-No.
Clamp inserts , see page 83.	
Tool set Cu-INOX with cutter wheel Cu-INOX 3–120, s 4	290433
REMS cutter wheel Cu-INOX 3–120, s 4	113210
Holder for work bench	290440



REMS RAG

Pipe chamfering tools

Handy quality tools for simple and fast external chamfering (15°) of pipes.

Plastic pipes Ø 16–250 mm, Ø ¾–10"

Wall thickness ≤ PN 16

REMS RAG – chamfering at 15°.

Chamfering at 15° on commonly used plastic pipes.

Also suited for deburring plastic pipes. Ensures easy joining of sleeves to be welded.

Easily adjusted for pipe diameter and wall thickness.

Very easy and fast chamfering thanks to efficient blade geometry.

Patent DE 44 09 983, patent US 5,641,253. Easy-to-slide V-block with two different bevel angles for good guidance of small pipe sizes.

In high-grade, glass-fibre reinforced polyamide.

Replaceable blades.



German Quality Product

Patent DE 44 09 983
Patent US 5,641,253

Supply format

REMS RAG. Pipe chamfering tool for plastic pipes. With blades. In a carton.

Description	Pipes Ø ≤ mm/inch	Art.-No.
P 16–110	16–110 / ¾–4"	292110
P 32–250	32–250 / 1¼–10"	292210

Accessories

Description	Art.-No.
Chamfering blades (pack of 2) for REMS RAG P 16–250	292011



REMS REG Universal

Universal deburrer

Universal quality tool for deburring tubes and edges of different materials.

Copper, steel, brass, aluminium, plastic.

REMS REG Universal – the all-purpose deburrer.

Robust metal design for tough use.

Easy handling and good grip thanks to ergonomically designed hexagon handle.

Rotating universal deburrer blade in handle accommodates to the work piece edge to be deburred.

Specially hardened and specially ground universal deburrer blade guarantees easy deburring and long service life.

Fast, simple blade replacement by pulling back the front sliding sleeve.

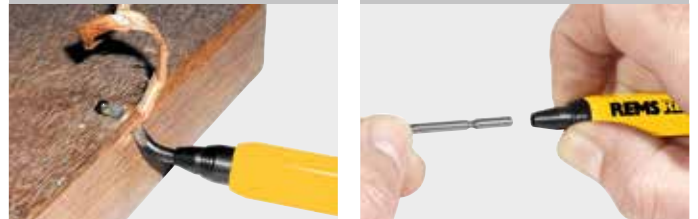

Supply format

REMS REG Universal. Universal deburrer. For copper, steel, brass, aluminium, plastic. On cardboard.

	Art.-No.	
	113910	

Accessories

Description	Art.-No.	
Universal deburring blade, ground	113360	

REMS REG St 1/4–2"

Inner pipe deburrer

Robust quality tool for inner pipe deburring.

For electric operation.

Steel pipes and other pipes Ø 1/4–2"

REMS REG St 1/4–2": effortless electric deburring.

Inner pipe deburrer with octagonal attachment head for operating by means of electric die stocks with octagonal seat, e.g. REMS Amigo E, REMS Amigo, REMS Amigo 2, REMS Amigo 2 Compact.

Specially hardened and designed deburring blade ensures easy deburring and extremely long life. Double edges for optimum chip flow, specially for small sizes.



German Quality Product



Supply format

REMS REG St 1/4–2". Inner pipe deburrer for electric operation. For steel pipes and other pipes, Ø 1/4–2". In a carton.

	Art.-No.	
	731700	

REMS REG 3–35

Outer-inner tube deburrer

Sturdy manual tool for outer-inner tube deburring.

Copper, brass, aluminium, steel, plastic tubes

Ø 3–35 mm
Ø 1/8–1 3/8"

REMS REG 3–35 – the sharp edge.

Fast, effortless deburring through 3 specially hardened and ground deburring blades.

Robust housing in shock-proof, resistant plastic.



German Quality Product

Supply format

REMS REG 3–35. Outer-inner tube deburrer. For copper, brass, aluminium, steel, plastic tubes, Ø 3–35 mm, Ø 1/8–1 3/8". In blister pack.

	Art.-No.	
	113900	

REMS REG 8-35

Outer-inner pipe deburrer

Robust quality tool for removing outer and inner burr from pipes.

Stainless steel pipes, other steel pipes, copper, brass, aluminium, plastic pipes

Ø 8-35 mm
Ø 3/8-1 3/8"

REMS REG 8-35 – the multiple edge up to Ø 35 mm.

Easy, effortless deburring through multiple blades which are specially hardened and ground.

Robust metal design for tough use.



Supply format

REMS REG 8-35. Outer-inner pipe and tube deburrer. For stainless steel pipes, other steel pipes, copper, brass, aluminium, plastic pipes, Ø 8-35 mm, Ø 3/8-1 3/8". In blister pack.

	Art.-No.	
	113825	

REMS REG 10-42

Outer-inner pipe deburrer

Robust, solid all-metal tool for outer-inner pipe and tube deburring. For manual or electric operation.

Stainless steel pipes, other steel pipes, copper, brass, aluminium, plastic pipes

Ø 10-42 mm
Ø 1/2-1 5/8"

REMS REG 10-42 – by hand or electric. Specially for stainless steel pipes.

Ideal for pipes of all types. Specially for stainless steel tubes of pressfitting systems.

Easy and fast deburring through an appropriate, solid all-metal tool, equipped with 4 specially hardened and ground deburring blades

Driver for electrical drive by REMS Helix cordless drill/screwdriver (see page 91) and other power drills/screwdrivers (speed ≤ 300 rpm), as an accessory.



German Quality Product



Supply format

REMS REG 10-42. Outer-inner pipe and tube deburrer for manual or electric operation. For stainless steel pipes, other steel pipes, copper, brass, aluminium, plastic pipes, Ø 10-42 mm, Ø 1/2-1 5/8". Without adapter for electric drive. In blister pack.

	Art.-No.	
	113810	

Accessories

Description	Art.-No.	
Adapter for REMS REG 10-42	113815	
REMS Helix, cordless drill/screwdriver, see page 91		



REMS REG 10-54

Outer-inner pipe deburrer

Robust quality tool for removing outer and inner burr from pipes.

Stainless steel pipes, other steel pipes, copper, brass, aluminium, plastic pipes

Ø 10-54 mm
Ø ½-2 1/8"

REMS REG 10-54 – the multiple edge up to Ø 54 mm.

Easy, effortless deburring through multiple blades which are specially hardened and ground.

Robust metal design for tough use.



Supply format

REMS REG 10-54. Outer-inner pipe and tube deburrer. For stainless steel pipes, other steel pipes, copper, brass, aluminium, plastic pipes, Ø 10-54 mm, Ø ½-2 1/8". In blister pack.

	Art.-No.
	113830

REMS REG 10-54 E

Outer-inner pipe deburrer

Robust quality tool for removing outer and inner burr from pipes. For manual operation or electric drive.

Stainless steel pipes, other steel pipes, copper, brass, aluminium, plastic pipes

Ø 10-54 mm
Ø ½-2 1/8"

REMS REG 10-54 E – by hand or electrically. Especially for stainless steel pipes.

Easy, effortless deburring through multiple blades which are specially hardened and ground.

Integrated hexagonal driver for electrical drive by REMS Helix cordless drill/screwdriver (see page 91) and other power drills/screwdrivers with 1/4" bit holders (speed ≤ 300 rpm), by the REMS Cento pipe cutting machine (see page 76) and by the REMS Turbo Cu-INOX pipe circular sawing machine (see page 64) (**Patent EP 2 058 067**).

Robust metal design for tough use.



Supply format

REMS REG 10-54 E. Outer-inner pipe and tube deburrer for manual or electric operation. For stainless steel pipes, other steel pipes, copper, brass, aluminium, plastic pipes, Ø 10-54 mm, Ø ½-2 1/8". In blister pack.







	Art.-No.
	113835

Accessories

Description
REMS Helix, cordless drill/screwdriver, see page 91
REMS Cento, pipe cutting machine, see page 76
REMS Turbo Cu-INOX, pipe circular sawing machine, see page 64



Assembling

	Water pump pliers	90
	Cordless power drill/screwdriver	91
	Pipe workstation Chain pipe vices	92
	Folding workbenches	93
	Material supports	94
	Battery LED Lamp	95

REMS Catch S

Swedish pattern wrench 'S'

Rugged quality tools for tough use and long service life.

All-steel, drop forged.

Swedish model according to DIN 5234 - Form C.

Pipes $\varnothing \leq 3''$

Nuts, bolts, flat material

REMS Catch S – for professional use.

Swedish model with S-shaped jaws for secure 3-point grip.

Self-locking thus secure gripping and holding even on smooth pipes.

Rugged design in chrome-vanadium steel, all steel, drop forged, tempered, powder-coated. Hardened, highly wear resistant toothing.

Ergonomically shaped handle, slip-proof. Stop prevents jamming.

Adjusting nut cannot be lost. Reinforced sleeve.



Supply format

REMS Catch S. Swedish pattern wrench 'S'. DIN 5234 – Form C. In plastic bag.

Description Pipes $\varnothing \leq$ inch	Width mm	Art.-No.
S 1/2"	36	116000
S 1"	47	116005
S 1 1/2"	60	116010
S 2"	78	116015
S 3"	112	116020



REMS Catch W

Water pump pliers

Rugged quality tools for tough use and long service life.

All-steel, drop forged.

According to ISO 8976 with box joint.

Pipes $\varnothing \leq 1\frac{1}{2}''$

Square, hexagonal joints, flat material

REMS Catch W – for professional use.

Gripping pliers with reinforced, ground, box joint. 7 grip positions.

Self-locking thus secure gripping and holding, even on smooth pipes.

Rugged design in chrome-vanadium steel, all-steel, drop forged, tempered, powder-coated. Hardened, highly wear resistant toothing.

Ergonomically shaped handle, slip-proof. Stop prevents jamming.



Supply format

REMS Catch W. Water pump pliers, 7 grip positions. ISO 8976. In plastic bag.

Description	Pipes $\varnothing \leq$ inch	Art.-No.
W 175	1"	116050
W 240	1 1/4"	116055
W 300	1 1/2"	116060



REMS Helix VE

Cordless power drill/screwdriver

Powerful, handy power tool for drilling, driving in/loosening screws and deburring pipes. For cordless and mains operation. For assembly, disassembly, repair.

Drilling in steel, stone	$\varnothing \leq 10 \text{ mm}$
Drilling in wood	$\varnothing \leq 28 \text{ mm}$
Drilling with tile drills, e.g. in ceramic, fine clay, granite, marble	$\varnothing \leq 14 \text{ mm}$
Driving in/loosening of screws	$\varnothing \leq 7 \text{ mm}$

REMS Helix VE – drilling, screw driving and deburring.

Design

Ultra light, ultra small, ultra handy. Drive machine with battery pack weighs only 1.3 kg. Can therefore be used everywhere, free hand, over head, also in very confined spaces. Optimum weight distribution for one-hand operation. Ergonomically designed housing. Drive machine with keyless quick chuck, clamping range 0.8–10 mm, right and left hand rotation. 2 continuously adjustable speed ranges from 0 to 300 rpm and 0 to 1,250 rpm, 25 torque stages plus drilling stage, high torque of 31 Nm in the low speed range for powerful screw driving. Integrated LED work light for illuminating the work place. Belt clip. For cordless and mains operation. 1 bit with double blade slot/cross-head, 50 mm long. Bit set as accessory.

Drive

Powerful electro-mechanical drive with powerful battery motor 14.4 V, 300 W output, robust, 2-step, precision, ball bearing-mounted planetary gear, maintenance-free. Safety switch.

Vario-Electronic

Continuous electronic speed control for gentle start drilling, driving in/loosening of screws and selection of the speed suitable for the material when drilling and driving in/loosening screws. The speed can be continuously controlled by variable pressure on the safety switch from 0 to 300 or 0 to 1,250 rpm (accelerator switch).

Battery or mains operation

Li-Ion PLUS technology. Highly resistant Li-Ion 14.4 V battery with 1.5 or 3.0 Ah capacity for long service life. Powerful and light. Li-Ion 14.4 V, 3.0 Ah battery for driving in more than 1,000 screws 4 x 40 mm in wood. Total discharge and overload protection with single cell monitoring. Temperature monitoring during the charging process. Operating temperature range – 10 to + 60 °C. No memory effect for maximum battery power. Rapid charger for short charging times.

Li-Ion 230 V voltage supply for mains operation instead of Li-Ion 14.4 V battery, as accessory.



Supply format

REMS Helix VE Li-Ion Set. Cordless power drill/screwdriver with Vario-Electronics (VE) for drilling in steel, stone, $\varnothing \leq 10 \text{ mm}$, wood $\varnothing \leq 28 \text{ mm}$ and other materials and for driving in/loosening screws $\varnothing \leq 7 \text{ mm}$. Drive machine with keyless quick chuck, clamping range 0.8–10 mm, right and left hand rotation. Electromechanical drive with powerful battery motor 14.4 V, 300 W, 2-step robust planetary gear. 2 continuously adjustable speed ranges from 0 to 300 rpm and 0 to 1,250 rpm, 25 torque stages plus drilling stage, high torque of 31 Nm in the low speed range. Safety switch. Integrated LED work light. Belt clip. Li-Ion 14.4 V, 1.6 Ah battery, Li-Ion/Ni-Cd 230 V, 50–60 Hz, 65 W rapid charger. 1 bit with double blade slot/cross-head, 50 mm long. In carrying bag.

	Art.-No.
	190010

Other voltages on request.

Accessories

Description	Art.-No.
REMS REG 10–42. Outer/inner pipe deburrer for pipes $\varnothing 10–42 \text{ mm}$, $\varnothing \frac{1}{2}–1\frac{1}{8}$ ", see page 86	
REMS REG 10–54 E. Outer/inner pipe deburrer for pipes $\varnothing 10–54 \text{ mm}$, $\varnothing \frac{1}{2}–2\frac{1}{8}$ ", see page 87	
REMS tile drilling , $\varnothing 5–14 \text{ mm}$, see page 236	
REMS Helix VE Li-Ion drive unit , without battery	190000
Battery Li-Ion 14.4 V, 1.5 Ah	571545
Battery Li-Ion 14.4 V, 3.0 Ah	571555
Rapid charger Li-Ion/Ni-Cd 230 V , 50–60 Hz, 65 W	571560
Voltage supply Li-Ion 230 V for mains operation instead of battery Li-Ion 14.4 V	571565
Carrying bag	190053
Bit set , comprising quick-change bit holder, magnetic, with automatic bit lock, 12 bits (4 Torx, 3 cross-head PH, 3 cross-head PZ, 2 slotted), in practical magazine with elastic band for fixing to wrist or to the power tool.	190051
REMS cordless LED lamp see page 95	175200



REMS Aquila 3B

Portable pipe workstation with chain pipe vice

Sturdy, easy to carry pipe workstation with integrated chain pipe vice on folding tripod stand. With practical shelf plate. For trade and industry. For the building site and the workshop.

Clamping range \varnothing 10–165 mm
 \varnothing 1/8–6"

REMS Aquila 3B – portable pipe workstation. Safe clamping of pipes up to 6". Everywhere on site.

Sturdy, torsion-free die-cast structure of the work plate with integrated chain pipe vice, pipe rest, tool holders, 3 benders for bending pipes \varnothing 10–26 mm, \varnothing 3/8–3/4", clamping head.

Specially toothed double clamping jaws, easily changeable, prism-shaped, for safe clamping of the pipes in the whole working range. Specially hardened, for long life.

Clamping chain with strong chain links, easy clamping by quick closure and trapezoidal threaded spindle.

Well accessible working range in front of the chain pipe vice for free swing of even long tools.

Especially suitable for pipe installation, e.g. for cutting, thread cutting, bending, assembly.

Adjustable clamping head for clamping the pipe workstation between the ceiling and the floor, for especially secure standing.

Proven tripod stand for secure standing, folding, for easy erection and transport.

Practical shelf plate for tools and work material.

REMS Herkules height adjustable material supports (see page 94).



Supply format

REMS Aquila 3B. Pipe workstation with chain pipe vice for clamping pipes \varnothing 10–165 mm, \varnothing 1/8–6". Work plate with integrated chain pipe vice with double clamping jaws, pipe rest, tool holders, 3 benders for bending pipes \varnothing 10–26 mm, \varnothing 3/8–3/4", clamping head. Folding tripod stand with shelf plate. In a carton.

	Art.-No.
	120270

REMS Aquila WB

Chain pipe vice for workbench

High quality, robust chain pipe vice for fixing to a workbench. Excellent quality for long life. For trade and industry. For the building site and the workshop.

Pipes \varnothing 10–165 mm
 \varnothing 1/8–6"

REMS Aquila WB – safe clamping of pipes up to 6".

Sturdy, torsion-free die-cast structure of the base plate with integrated chain pipe vice, pipe rest, bender.

Specially toothed double clamping jaws, easily changeable, prism-shaped, for safe clamping of the pipes in the whole working range. Specially hardened, for long life.

Clamping chain with strong chain links, easy clamping by quick closure and trapezoidal threaded spindle.

Well accessible working range in front of the chain pipe vice for free swing of even long tools.

Especially suitable for pipe installation, e.g. for cutting, thread cutting, bending, assembly.

For fixing to the workbench.

REMS Herkules height adjustable material supports (see page 94).



German Quality Product

Supply format

REMS Aquila WB. High quality chain pipe vice for clamping pipes \varnothing 10–165 mm, \varnothing 1/8–6". Base plate with integrated chain pipe vice with double clamping jaws, pipe rest, bending device. For work bench. In a carton.

	Art.-No.
	120250

Sturdy, easy to carry folding workbenches for universal use. Worktop in accordance with DIN 68 705. For trade and industry. For the building site and the workshop.

REMS Jumbo E – handy and light.

Work top	Birch-Multiplex, 800 × 600 mm
Height	800 mm
Weight	23 kg
Load capacity	≤ 300 kg

REMS Jumbo – the indestructible folding workbench. Handy and light. German quality product.

Work top	Beech-Multiplex, 1100 × 700 mm
Height	800 mm
Weight	28 kg
Load capacity	≤ 300 kg

REMS Jumbo – assembled and disassembled at lightning speed. With toggle catch. Worktops in accordance with DIN 68 705. Highly resistant up to 300 kg.

Handy and light. REMS Jumbo E only 23 kg, REMS Jumbo only 28 kg.
 Worktop made of special Birch-Multiplex plywood (REMS Jumbo E) or Beech-Multiplex plywood (REMS Jumbo), in accordance with DIN 68 705 weather-proof glued, impregnated, vice-proof and tear-proof, flat and torsion-free.
 Impact and splinter resistant thanks to steel edge protection. Screws and nuts galvanised,
 Especially safe standing by strong tubular steel frame with toggle catch, assembled and disassembled at lightning speed. Easy to carry.
 Highly resistant, max. load capacity 300 kg.



German Quality Product



Supply format

REMS Jumbo. Folding workbench with toggle catch. Worktop in accordance with DIN 68 705. In a carton.

Description	Work top	Size mm	Art.-No.
REMS Jumbo E	Birch-Multiplex	800 × 600	120240
REMS Jumbo	Beech-Multiplex	1100 × 700	120200

REMS Herkules

Material supports

Vertically adjustable material support with roller guidance for rotating and stationary pipe and solid material. For trade and industry. For the building site and the workshop.

Pipes	\varnothing (1/8) 3/4–6", \varnothing (6) 26–168 mm
Solid material	\varnothing (6) 26–150 mm

REMS Herkules – the sturdy support.

Easy moving of the material in all directions when turning, pulling and pushing by two stainless steel balls mounted in a rust-protected housing in the range \varnothing 3/4–6", \varnothing 26–168 mm.

Especially suitable for pipe installation, e.g. for cutting, thread cutting, roll grooving, welding, soldering.

Robust, job site-proven design. Dismantles for transport and stocking.

Optionally on safe standing tripod or with clamping device for workbench.



German Quality Product



Supply format

REMS Herkules. Vertically adjustable material support for pipes \varnothing (1/8) 3/4–6", \varnothing (6) 26–168 mm, solid material \varnothing (6) 26–150 mm. Optionally on tripod or with clamping device for workbench. In a carton.

Description	Version	Art.-No.
REMS Herkules 3B	Tripod with protection caps	120120
REMS Herkules Y	Clamping fixture for work bench	120130



REMS battery LED Lamp

Hand and standing lamp

Practical, ultra light hand and standing lamp for lighting up the work place. For battery and mains operation.

**REMS cordless LED lamp – lights everywhere.
For cordless and mains operation.
145° continuously tiltable.**

Ultra light hand and standing lamp.

LED technology with high brilliance

Ergonomically designed handle with soft grip

Battery compartment integrated into the handle Li-Ion 14.4 V batteries or Li-Ion 230 V power supply for mains operation in place of Li-Ion 14.4 V battery as an accessory.

Electronic charging status check with low discharge protection.

Practical, foldout hanging device

Lamp head continuously tiltable by 145° for better illumination.

Rapid charger for short charging times, as an accessory.

No memory effect for maximum battery performance.



Supply format

REMS cordless LED. Lamp Hand and standing lamp for Li-Ion 14.4 V batteries or Li-Ion 230 V voltage supply. Without battery, without rapid charger, without voltage supply. In blister pack.

	Art.-No.
	175200







Accessories

Description	Art.-No.
Battery Li-Ion 14.4 V, 1.5 Ah	571545
Battery Li-Ion 14.4 V, 3.0 Ah	571555
Rapid charger Li-Ion/Ni-Cd 230 V, 50–60 Hz, 65 W	571560
Voltage supply Li-Ion 230 V for mains operation instead of battery Li-Ion 14.4 V	571565





Testing
Cleaning
Disinfecting
Preserving
Flushing
Filling

	Hand pressure testing pump	98
	Electric pressure testing pump	99
	Electronic flushing and pressure testing unit with compressor	100
	Disinfection unit TW, cleaning and preservation unit H	103
	Machine cleaner	103
	Electric filling and flushing unit	104

REMS Push

Hand pressure testing pump

Proven, reliable testing pump for pressure and tightness tests of piping systems and receptacles.

Testing and pressure range $p \leq 6 \text{ MPa}/60 \text{ bar}/870 \text{ psi}$

Water, oil, glycol

pH-value of liquids 7 – 12

Temperature of liquids $\leq 60^\circ\text{C}$

Viscosity of liquids $\leq 1.5 \text{ mPa s}$

REMS Push – reliable pressure hold.

Universal use

For plumbing, heating, solar system and sprinkler installations, for compressed air, steam and cooling systems, oil installations, for boiler and pressure vessel building.

Design

Robust, job-site proven metal design for tough use. REMS Push with corrosion-resistant, powder-coated 12 ltr steel tank. Distortion resistant lever with ergonomic handle, doubles as carrying handle when locked. Wear resistant pressure piston in brass, $\varnothing 30 \text{ mm}$. High-pressure hose with $\frac{1}{2}$ "-connection. Fine scale pressure gauge (accessory), $p \leq 1.6 \text{ MPa}/16 \text{ bar}/232 \text{ psi}$, for reading a pressure change of $0.01 \text{ MPa}/0.1 \text{ bar}/1.45 \text{ psi}$ for tightness testing according to DIN 1988, as accessory.

Stainless steel tank

REMS Push INOX with 12 ltr stainless steel tank. For extremely long life.

Functioning

Pressure and tightness test with water or oil. Double valve system for reliable pressure built-up, with rust-proof steel balls. High pumping capacity with long stroke, fine pressure adjustment at short pushes. High pressure hose with fabric ply prevents measurement errors.



Supply format

REMS Push. Hand pressure testing pump with pressure gauge, $p \leq 6 \text{ MPa}/60 \text{ bar}/870 \text{ psi}$, for pressure and tightness testing of piping systems and receptacles up to $6 \text{ MPa}/60 \text{ bar}/870 \text{ psi}$. Corrosion-resistant, powder-coated 12 ltr steel tank. 1.5 m high-pressure hose with $\frac{1}{2}$ "-connection. In a carton.

	Art.-No.
	115000



Supply format

REMS Push INOX. Hand pressure testing pump with pressure gauge, $p \leq 6 \text{ MPa}/60 \text{ bar}/870 \text{ psi}$, for pressure and tightness testing of piping systems and receptacles up to $6 \text{ MPa}/60 \text{ bar}/870 \text{ psi}$. 12 ltr stainless steel tank. 1.5 m high-pressure hose with $\frac{1}{2}$ "-connection. In a carton.

	Art.-No.
	115001



Accessories

Description	Pressure $p \leq \text{MPa}/\text{bar}/\text{psi}$	Art.-No.
Connecting piece with pressure gauge and shut off valve	6/60/870	115110
Fine scale pressure gauge	1,6/16/232	115045



REMS E-Push 2

Electric pressure testing pump

Powerful, electric pressure testing pump for pressure and tightness tests of piping systems and receptacles.

Testing and pressure range $p \leq 6 \text{ MPa}/60 \text{ bar}/870 \text{ psi}$

Pumping capacity 6.5 l/min

Water, hydrous solutions, emulsions

pH-value of liquids 7–10

Temperature of liquids $\leq 60^\circ\text{C}$

Viscosity of liquids $\leq 1.5 \text{ mPa s}$

REMS E-Push 2 – electric charging and testing. Up to 60 bar. With adjustable pressure limiting. 1300 W. Self sucking.

Universal use

In sanitary, heating, solar and sprinkler installation, for compressed air, steam and cooling systems, oil installations, in boiler and pressurised vessel construction.

Design

Robust, compact, light. Weighs only 12 kg. Easy to carry. Wear reduced high power piston pump. Pressure gauge, damped by filling with glycerine, $p \leq 6 \text{ MPa}/60 \text{ bar}/870 \text{ psi}$. High-pressure hose with fabric ply prevents measurement errors. Suction hose with suction filter. Non-return valve in the suction hose prevents the suction hose from running empty in standstill times; therefore shorter suction times. Suction hose and high pressure hose with $\frac{1}{2}$ "-connection. Connecting piece with pressure gauge, $p \leq 6 \text{ MPa}/60 \text{ bar}/870 \text{ psi}$, and shut off valve for pressure and tightness testing also after removal of the high pressure pump, e.g. theft protection or for use at several testing points, as accessory. Fine scale pressure gauge, $p \leq 1.6 \text{ MPa}/16 \text{ bar}/232 \text{ psi}$, for reading a pressure change of $0.01 \text{ MPa}/0,1 \text{ bar}/1.45 \text{ psi}$ for tightness testing according to DIN 1988, as accessory.

High power piston pump

Self-sucking high power piston pump running in a sealed oil bath with wear reduced pressure piston in stainless steel. Proven, powerful capacitor motor, 1300 W, very powerful and fast. High pumping capacity of 6.5 l/min. Pressure and tightness testing up to 6 MPa/60 bar/870 psi.

Adjustable pressure limiting

Pressure limiting in 6 stages, 1–6 MPa/10–60 bar/145–870 psi, adjustable to the necessary pressure in the pipe system/tank.



Supply format

REMS E-Push 2. Electric pressure testing pump with pressure gauge, $p \leq 6 \text{ MPa}/60 \text{ bar}/870 \text{ psi}$, for pressure and leak testing of pipe systems and tanks up to 6 MPa/60 bar/870 psi, with adjustable pressure limiting. Pump unit with capacitor motor 230 V, 50 Hz, 1300 W. Non-return valve. 1.5 m high-pressure hose with $\frac{1}{2}$ "-connection. In a carton.

	Art.-No.
	115500

Accessories

Description	Pressure $p \leq \text{MPa}/\text{bar}/\text{psi}$	Art.-No.
Connecting piece with pressure gauge and shut off valve	6/60/870	115110
Fine scale pressure gauge	1,6/16/232	115045



REMS Multi-Push

Electronic flushing and pressure testing unit with compressor

Powerful, compact, electronic flushing and pressure testing unit with oil-free compressor. For flushing with water or a water/air mixture, disinfection, cleaning, preservation of pipe systems, for pressure testing of pipe systems and vessels with compressed air or water, as a pneumatic pump for controlled filling of all types of vessels with compressed air and for operation of pneumatic tools.

Flushing

Water pressure pipe network $p \leq 1 \text{ MPa}/10 \text{ bar}/145 \text{ psi}$
 Pipe diameter installation $\leq \text{DN } 50, 2''$

Disinfection of drinking water installations

Cleaning and preservation of heating systems

Water temperature $5 - 35^\circ\text{C}$

Water flow $\leq 5 \text{ m}^3/\text{h}$

Pressure test

with compressed air $p \leq 0,4 \text{ MPa}/4 \text{ bar}/58 \text{ psi}$

Pressure test with water $p \leq 1,8 \text{ MPa}/18 \text{ bar}/261 \text{ psi}$

Pneumatic pump for controlled filling of all types of vessels with compressed air $p \leq 0,8 \text{ MPa}/8 \text{ bar}/116 \text{ psi}$

Operation of pneumatic tools

Operating pressure $p \leq 0,8 \text{ MPa}/8 \text{ bar}/116 \text{ psi}$

Suction rate $\leq 230 \text{ NI}/\text{min}$

REMS Multi-Push – just one device with more than 10 automatically running flushing and pressure testing programs. Permanent process monitoring. Logging. USB interface.

Universal use

Only **one** device for flushing with water or a water/air mixture, disinfection, cleaning, preservation of pipe systems, for pressure testing of pipe systems and vessels with compressed air or water, e.g. drinking water installations, radiators or area heating systems, for pressure testing of gas installations with compressed air, as a pneumatic pump for controlled filling of all types of vessels with compressed air, e.g. for pumping up expansion vessels or tyres and for operating pneumatic tools. **(Patent EP pending).**

Design

Powerful, compact, electronic flushing and pressure testing unit with oil-free compressor. Handy, easily portable, REMS Multi-Push SL only 37 kg, REMS Multi-Push SLW only 39 kg. Measuring and control devices for automatically running the flushing and test programs and for documenting the results. Safety devices for avoiding contamination of the pipe network by flow-back. Overpressure valves for pressure limiting. 5 µm condensation and particle filters. Large tubular steel frame as a compressed air tank. Two practical handles for easy carrying. Space-saving, folding handle grip for easy movement. Mobile tubular steel frame with two rubber-tyred wheels for easy transport and 2 rubber feet for firm standing. Connecting cable with integrated personal protection switch (PRCD). Captive seals for inputs and outputs of the REMS Multi-Push to avoid contamination during transport and storage.

REMS Multi-Push SLW additionally with hydro-pneumatic water pump for generating the necessary water pressure for hydrostatic pressure testing of pipe systems and vessels with water.

Compressor

Proven, powerful, oil-free piston compressor with crank drive, maintenance-free, with capacitor motor 230 V, 1,500 W. Pressure gauge for displaying the air pressure in the compressed air tank. Emergency stop button.

Hoses

Transparent 1" suction/pressure hose with fabric inlay, 1.5 m long, with 1" screw fittings for flushing, disinfection, cleaning, preservation and pressure testing with water. High-pressure hose ½", with fabric inlay, 1.5 m long, with ½" screw fittings, for pressure testing with water. Captive caps for the inputs and outputs of the hoses to avoid contamination during transport and storage. Compressed air hose 8 mm, 1.5 m long, with quick coupling DN 5 and ½" screw fitting, for pressure testing with compressed air. Connecting hose compressor/water connections, 0.6 m long, with quick coupling DN 7.2 and 1" screw fitting, 1" double nipple, for blowing out water remains from REMS Multi-Push and suction/pressure hoses at the end of work.

Patent EP pending.



Input and control unit

Easy to operate. Menu-guided input and menu-guided control of more than 10 flushing and test programs in 26 languages with edit option for the user to adapt the factory-set test criteria (test sequences, pressures and times) or defaults to the respective national safety provisions, rules and regulations valid for the application site. Format selection for date and time and selection of the different units. Input and control unit with 3" display with modern LCD technology, 76 mm screen diagonal, 128 × 64 pixels. Permanent process monitoring during the program sequences. USB port for USB stick or printer. The respective latest version software for the input and control unit is available via USB stick as a download under www.rems.de → Downloads → Software.

Flushing

Flushing of drinking water installations with water or with a water/air mixture with intermittent compressed air in accordance with EN 806-4:2010 and information leaflet "Flushing, Disinfection and Commissioning of Drinking Water Installations" (August 2014) of the German Central Association for Sanitary, Heating and Air Conditioning (ZVSHK) and for flushing of radiators and area heating systems.

Disinfection

REMS V-Jet TW disinfection unit for disinfection of drinking water installations in accordance with EN 806-4:2010 and information leaflet "Flushing, Disinfection and Commissioning of Drinking Water Installations" (August 2014) of the German Central Association for Sanitary, Heating and Air Conditioning (ZVSHK) and other pipe systems, as an accessory. REMS Peroxi Color, consisting of a 1l bottle of REMS Peroxi dosing solution for disinfection of approx. 100l line volume and 20ml bottle of red REMS Color dye for dyeing the dosing solution for filling and wash-out check (see page 103).

Cleaning and preservation

REMS V-Jet H cleaning and preservation unit for cleaning and preserving heating systems, as an accessory. Cleaner, dyed green for filling and wash-out check and corrosion protection, dyed blue for filling check, for approx. 100 l line volume respectively (see page 103).

Pressure testing with compressed air

Leak testing of drinking water installations with compressed air according to information leaflet "Leak Testing of Drinking Water Installations with Compressed Air, Inert Gas or Water" (January 2011) of the German Central Association for Sanitary, Heating and Air Conditioning (ZVSHK), leak testing of gas installations with compressed air according to the technical rule "DVGW-TRGI 2008, Technical Rules for Gas Installations - DVGW Worksheet G 600" of the German Gas and Water Association (DVGW) and leak testing of other pipe systems and vessels with compressed air.

Load testing of drinking water installations with compressed air according to information leaflet "Leak Testing of Drinking Water Installations with Compressed Air, Inert Gas or Water" (January 2011) of the German Central Association for Sanitary, Heating and Air Conditioning (ZVSHK), load testing of gas installations with compressed air according to the technical rule "DVGW-TRGI 2008, Technical Rules for Gas Installations - DVGW Worksheet G 600" of the German Gas and Water Association (DVGW) and load testing of other pipe systems and vessels with compressed air.

Pressure testing with water

REMS Multi-Push SLW with hydro-pneumatic water pump for hydrostatic pressure testing of drinking water installations with water in accordance with EN 806-4:2010, test method A, B or C or test method B, modified in accordance with information leaflet "Leak Testing of Drinking Water Installations with Compressed Air, Inert Gas or Water" (January 2011) of the German Central Association for Sanitary, Heating and Air Conditioning (ZVSHK) and for pressure testing of other pipe systems and vessels.

Pneumatic pump

Pneumatic pump for controlled filling of all types of vessels with compressed air ≤ 0.8 MPa/8 bar/116 psi, with automatic switch-off on reaching the preset air pressure, e.g. for pumping up expansion vessels or tyres.

Operation of pneumatic tools

Connection for pneumatic tools up to an air requirement ≤ 230 l/min, adjustable, for adaptation to the pneumatic tool being used. Pressure gauge for controlling the air pressure supplied by the compressed air tank. Pneumatic hose with quick coupling DN 7.2, as an accessory.

Logging

Results of the flushing and test programs are saved with date, time and log number in the selected language and can be transferred to USB stick or printer for documentation. Additions to saved data, e.g. customer name, project number, tester, are possible on external devices (e.g. PC, laptop, tablet-PC, Smartphone).



REMS Multi-Push

Electronic flushing and pressure testing unit with compressor

Supply format

REMS Multi-Push SL Set. For flushing with water or a water/air mixture, disinfection, cleaning, preservation of pipe systems, for pressure testing of pipe systems and vessels with compressed air, as a pneumatic pump for controlled filling of all types of vessels with compressed air $p \leq 0.8 \text{ MPa}/8 \text{ bar}/116 \text{ psi}$, and for operation of pneumatic tools $\leq 230 \text{ Nl/min}$. Input and control unit Piston compressor with crank drive, capacitor motor 230 V, 50 Hz, 1500 W. Person circuit breaker (PRCD). Mobile tubular steel frame. Fastenings for water inputs and outputs of the REMS Multi-Push. Two 1" suction/pressure hoses, with fabric inlay, 1.5 m long, with 1" screw fittings, fastenings for inputs and outputs. 1 compressed air hose 8 mm, 1.5 m long, with quick coupling DN 5 and 1/2" screw fitting, for pressure testing with compressed air. Connecting hose compressor/water connections, 0.6 m long, with quick coupling DN 7.2 and 1" screw fitting, 1" double nipple, for blowing out water remains from REMS Multi-Push and suction/pressure hoses at the end of work. Without disinfection unit, without cleaning and preservation unit. In a carton

	Art.-No.	
	115610	

Other voltages on request.



Supply format

REMS Multi-Push SLW Set. Same as REMS Multi-Push SL Set, Art. No. 115610, additionally with hydro-pneumatic water pump and 1 1/2" high pressure hose, 1.5 m long, with 1/2" hose screw fittings, fastenings for input and output, for pressure testing of pipe systems and vessels with water. In a carton.

	Art.-No.	
	115611	

Other voltages on request.



Accessories

Description	Art.-No.	
Fine filter with fine filter cartridge 90 µm , washable, with large dirt collection vessel	115609	
Fine filter cartridge 90 µm , for fine filter with fine filter cartridge 90 µm	043054	
Pressure gauge, $p \leq 6 \text{ MPa}/60 \text{ bar}/870 \text{ psi}$, for pressure and leak testing of pipe systems and vessels up to 6 MPa/60 bar/870 psi.	115140	
Fine scaled pressure gauge, $p \leq 1.6 \text{ MPa}/16 \text{ bar}/232 \text{ psi}$, for pressure and leak testing of pipe systems and vessels up to 1.6 MPa/16 bar/232 psi.	115045	
Fine scaled pressure gauge, $p \leq 250 \text{ hPa}/250 \text{ mbar}/3.6 \text{ psi}$, for pressure and leak testing of pipe systems and vessels up to 250 hPa/250 mbar/3.6 psi.	047069	
Pneumatic hose DN 7.2 for connecting pneumatic tools, with DN 7.2 quick coupling	115621	
Pneumatic hose 8 mm , 7 m long, with quick coupling DN 5 and 1/2" screw fitting, for pressure testing with compressed air.	115667	
High pressure hose 1/2" , 7 m long, with 1/2" screw fittings, fastenings for input and output, for pressure testing of pipe systems and vessels with water.	115661	
1" suction/pressure hose , with fabric inlay, 1.5 m long, with 1" screw fittings for flushing, disinfection, cleaning, preservation and pressure testing with water.	115633	
Double nipple 1" , for connecting 2 suction/pressure hoses and blowing out the suction/pressure hoses	045159	



REMS Multi-Push

Electronic flushing and pressure testing unit with compressor

Description	Art.-No.
Printer for printing the stored results of the flushing and test programs, 1 roll of paper, USB connecting cable, power supply/charger Ni-Mh 100–240 V, 50–60 Hz, 3 W	115604
Paper roll , pack of 5 for printer	090015
REMS V-Jet TW , disinfection unit for drinking water installations, for feeding dosing solution for disinfection	115602
REMS Peroxi Color , 1 l bottle of REMS Peroxi dosing solution for disinfection of approx. 100 l line volume and 20 ml bottle of red REMS Color dye for dyeing the dosing solution for filling and wash-out check.	115605
Test strips H₂O₂: 0–1,000 mg/l, pack of 100 , for checking the concentration of the disinfection solution	091072
Test strips H₂O₂: 0–50 mg/l, pack of 100 , for checking the complete flushing out of the disinfection solution after disinfection	091073
REMS V-Jet H , cleaning and preservation unit for heating systems, for feeding cleaner and corrosion protection.	115612
REMS CleanH 1 l bottle of cleaner for heating systems, dyed green for filling and wash-out check, for approx. 100 l line volume.	115607
REMS NoCor 1 l bottle of corrosion protection for preservation of heating systems, dyed blue for filling check, for approx. 100 l line volume.	115608



REMS CleanM

Machine cleaner

Highly effective machine cleaner for fast, reliable removal of oily and greasy soiling of all kinds. For cleaning and degreasing machines, tools etc. For trade and industry.

REMS CleanM – you can't get cleaner than that. Very high cleaning effect.

Especially for fast, reliable removal of oily and greasy soiling of all kinds. Easily biodegradable according to OECD 302 B. Free from substances classified as harmful to the environment.

Universal cleaner for trade and industry. For cleaning and degreasing machines and tools.

Can also be used for removing lime scale.

REMS CleanM spray bottle without propellant.



German Quality Product

Supply format

REMS CleanM. Highly effective machine cleaner for fast and reliable removal of oily and greasy soiling. For cleaning and degreasing machines, tools etc.

Packing	Art.-No.
500 ml spray bottle	140119



REMS Solar-Push

Electric filling and flushing unit

Powerful electric filling and flushing unit for fast, easy filling, flushing and venting of closed systems. Ideal for solar power systems, ground heat systems and underfloor/wall heating.

Tank volume 30 litres

REMS Solar-Push K 60 with centrifugal pump

Transport capacity at 40 m pumping head 16 l/min

Transport volume ≤ 36 l/min

Transport pressure ≤ 0.55 MPa/5.5 bar/80 psi

Temperature of the transported media (constant load) ≤ 60°C

pH value of the transported media 7–8

REMS Solar-Push I 80 with impeller pump

Transport capacity at 40 m pumping head 18 l/min

Transport volume ≤ 27 l/min

Transport pressure ≤ 0.65 MPa/6.5 bar/94 psi

Temperature of the transported media (constant load) ≤ 80°C

pH value of the transported media 7–8

Media transported: heat transfer liquids, antifreeze, water, aqueous solutions, emulsions

REMS Solar-Push – filling, flushing and venting in one action. Self priming. High transport capacity.

System advantage

Filling, flushing and venting in one action. Ideal for solar power systems, ground heat systems and underfloor/wall heating. Also for filling tanks.

Design

Powerful, electric filling and flushing unit on stable, mobile tubular steel frame for secure standing. 2 large, air-filled tyres for easy transport in rugged building site conditions. Practical hose holder. Low weight, only 19 kg. Sturdy plastic tank to hold 30 litres, made of UV-stabilised PE, with filling level indicator, removable, for easy cleaning, with large opening for easy filling. Practical screw cap for fast opening and closing. Return connection ¾" with immersion pipe avoids foaming of the transport medium when it enters the plastic tank. Stop tap for easy cleaning and easy changing of the plastic tank when using different transport media. Two practical handles for easy carrying of the plastic tank. High temperature-resistant connecting hose between plastic tank and pump. Fine filter in the suction line with large viewing window for easy recognition of residue air in the circuit as well as emitted contamination, e.g. chips, solder and welding residue.

REMS Solar-Push K 60

Self-suction centrifugal pump, suitable for different transport media, e.g. heat transfer liquids, antifreeze, water, aqueous solutions, emulsions. With proven, powerful condenser motor with quiet running, 860 W, on/off switch. High transport volume 36 l/min for fast filling, efficient flushing and venting of closed systems and for filling tanks. Pressure relief valve for simple pressure relief in the pressure hose at the end of operation, as an accessory. For continuous load ≤ 60°C. 2 pieces flexible, transparent PVC fabric hoses ½" T60, for pressure and return lines, each 3 m long, with ¾" screw connections, temperature-resistant ≤ 60°C.

REMS Solar-Push I 80

Dry self-suction impeller pump with special impeller, suitable for different transport media, e.g. heat transfer liquids, antifreeze, water, aqueous solutions, emulsions. With proven, powerful condenser motor with quiet running, 1000 W, on/off switch. High transport volume 27 l/min for fast filling, efficient flushing and venting of closed systems and for filling tanks. Pressure relief valve for simple pressure relief in the pressure hose at the end of operation. For continuous load ≤ 80°C. 2 pieces flexible, EPDM fabric hoses ½" T100 (synthetic rubber), for pressure and return lines, each 3 m long, with ¾" screw connections, high temperature-resistant ≤ 100°C.

Extensive accessories

Shut-off valve for closing the pressure or return line, e.g. during transport. Fine filter with fine filter bag 70 µm, consisting of a screw cap with return line connection for return line with ¾" union, adapter and fine filter bag 70 µm, or fine filter with fine filter cartridge 90 µm, washable, with large dirt collection vessel, for return line with ¾" connection for flushing underfloor heating/wall radiators and clearing sludge. Flow direction changeover valve complete with EPDM fabric hose ½" T100, for flushing underfloor heating/wall radiators and effective clearance of sludge by pressure surges when flow direction changes. Changeover valve for alternative suction of the transport medium from another tank, e.g. for larger volumes.



K 60



I 80



Supply format

REMS Solar-Push K 60. Electric filling and flushing unit for fast, easy filling, flushing and venting of closed systems. Transport volume ≤ 36 l/min, tank volume 30 l. With centrifugal pump, temperature-resistant for continuous load $\leq 60^\circ\text{C}$. Transport pressure $\leq 0,55$ MPa/5,5 bar/80 psi. Condenser motor 230 V, 50 Hz, 860 W. 2 pieces flexible, transparent PVC fabric hoses $\frac{1}{2}$ " T60, each 3 m long, temperature-resistant $\leq 60^\circ\text{C}$. In box.

	Art.-No.	
	115312	

Other voltages on request.



Supply format

REMS Solar-Push I 80. Electric filling and flushing unit for fast, easy filling, flushing and venting of closed systems. Transport volume ≤ 27 l/min, tank volume 30 l. With impeller pump, temperature-resistant for continuous load $\leq 80^\circ\text{C}$. Transport pressure $\leq 0,65$ MPa/6,5 bar/94 psi. Transport capacity at 40 m transport height 10 l/min. Condenser motor 230 V, 50 Hz, 1000 W. Pressure relief valve. 2 pieces flexible, EPDM fabric hoses $\frac{1}{2}$ " T100, each 3 m long, high temperature-resistant $\leq 100^\circ\text{C}$. In box.

	Art.-No.	
	115311	

Other voltages on request.







Accessories

Description	Art.-No.
PVC fabric hose $\frac{1}{2}$" T60 for pressure or return line, 3 m long, with $\frac{3}{4}$ " screw connections, temperature-resistant $\leq 60^\circ\text{C}$.	115314
EPDM fabric hose $\frac{1}{2}$" T100 for pressure or return line, 3 m long, with $\frac{3}{4}$ " screw connections, high temperature-resistant $\leq 100^\circ\text{C}$.	115315
EPDM fabric hose $\frac{1}{2}$" T165 for pressure or return line, 3 m long, with $\frac{3}{4}$ " screw connections, high temperature-resistant $\leq 165^\circ\text{C}$.	115319
$\frac{3}{4}$" shut-off valve for closing the pressure or return line, e.g. during transport.	115324
30 l plastic tank made of UV-stabilised PE.	115375
Pressure relief valve for Solar-Push K 60.	115217
Fine filter with fine filter bag $70\ \mu\text{m}$, consisting of a screw cap with return line connection for return line with $\frac{3}{4}$ " union, adapter, 1 fine filter bag $70\ \mu\text{m}$, for flushing underfloor heating/wall radiators and clearing sludge	115220
Fine filter bag $70\ \mu\text{m}$ (pack of 10) , fine filter with fine filter bag $70\ \mu\text{m}$	115221
Fine filter with fine filter cartridge $90\ \mu\text{m}$, washable, with large dirt collection vessel, for return line with $\frac{3}{4}$ " union, for flushing underfloor heating/wall radiators and clearing sludge	115323
Fine filter cartridge $90\ \mu\text{m}$, for fine filter with fine filter cartridge $90\ \mu\text{m}$	043054
Flow direction changeover valve complete with EPDM fabric hose $\frac{1}{2}$ " T100, for flushing underfloor heating/wall radiators and effective clearance of sludge by pressure surges when flow direction changes	115326
Changeover valve for alternative suction of the transport medium from another tank, e.g. for larger volumes.	115325



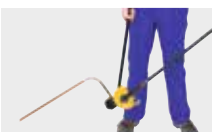

Bending

	Hydraulic pipe bender	108
	Single-hand tube bender	110
	Electric pipe and tube bender	111
	Cordless tube bender	114
	Hand tube bender	116

Robust, hydraulic pipe bender for dimensionally accurate bending of pipes up to 90°. For trade and industry. For the building site and the workshop.

Steel pipes EN 10255 (DIN 2440)	Ø ¾–2"
Multilayer composite tubes	Ø 32–75 mm

REMS Python – extremely easy bending up to Ø 2", 75 mm. Ideal for steel pipes EN 10255 and for multilayer composite tubes of the pressfitting systems. Also for producing level bends in different planes.

Universal use

For locksmith work, sanitary and heating installation and machine and plant engineering. Excellently suitable for steel pipes EN 10255 (DIN 2440) and for multilayer composite tubes of the pressfitting systems.

System advantage

Only **one** bender drive for the whole working range up to Ø 2", Ø 75 mm. Thus simple, inexpensive stocking. No confusion possible.

Cost advantage

Pipe bender is amortised after just a few bends by saving on fittings. No costs for fittings, storage, procurement. Saving of welds, press connections and working time. Increased safety due to fewer pipe connections.

Design

Robust, compact pipe bender with closed, maintenance-free hydraulic system. 2 slide roller supports and 2 slide rollers form a closed bending frame for high rigidity and precision when bending. Upper back former support tiltable for easy insertion and removal of the pipe, with marked plug positions for the back formers according to the pipe size to be bent, with angle scale 0 to 90°. Upper slide roller support with laterally adjustable slide roller bearing plate for producing over-bends and level bends according to requirements also in different planes. Can be used anywhere, any time. No setting. Easy, effortless, quick working, e.g. 90° bend Ø 63 mm only 60 s. Tripod as accessory.

Bending formers and back formers

Bending formers St for steel pipes, form and pressure stable, made of highly resistant spheroidal iron. Bending formers V for multilayer composite tubes, form and pressure stable, made of torsion-free shell-cast aluminium. See page 109. Marking on every bending former for dimensionally accurate bending. Angle gauge with angle scale 0 to 180° for dimensionally accurate bending, as an accessory. Optimum matching of bending formers and back formers guarantees material-compatible bending without cracks and creases. High strength back formers for low friction support of the thrust pressure. Fast changing of the bending formers and back formers by simple plug system.

Drive

Hydraulic drive unit with hydraulic cylinder made of high quality, rolled hydraulic tube. Overload protection of the hydraulic thrust in the foremost piston position for safe working. Ergonomically designed thrust lever for strength saving pressure build-up with manual hydraulic pump. No danger of crushing due to end limiting of the thrust lever, for high work safety.



German Quality Product





Supply format

REMS Python Set. Hydraulic pipe bender for dimensionally accurate bending of pipes up to 90°. Steel pipes EN 10255 Ø ¾–2", multilayer composite tubes Ø 32–75 mm. Bender drive with slide roller supports, upper slide roller support with laterally adjustable slide roller bearing plate, 2 slide rollers, bending segments St or V. In sturdy carrying case.

Description	Art.-No.
Set St ¾-½-¾-1-1¼"	590020
Set St ½-¾-1-1¼-1½-2"	590021
Set V 40-50-63 mm	590022

Accessories

Description	Art.-No.
Bender drive with back former supports and back formers	590000
Slide piece Ø 75 mm (pack of 2)	590111
Tripod	590150
Carrying case with practical handles	590160
Angle gauge for dimensionally accurate bending	590153

Bending former for pipes Ø mm/inch	Bending radius ¹⁾ mm	Bending radius ²⁾ mm	suitable for				Art.-No.
			St 10255	>			
St ¾"	50		•				590051
St ½"	65		•				590052
St ¾"	85		•				590053
St 1"	100		•				590054
St 1¼"	150		•				590055
St 1½"	170		•				590056
St 2"	220		•				590057
V 32 mm	112	128		•			590061
V 40 mm	140	160		•			590058
V 50 mm	175	200		•			590059
V 63 mm	220	252		•			590060
V 75 mm	260	298		• ³⁾			590062

St 10255: Steel pipes (threaded pipes) EN 10255 (DIN 2440)
 V: multilayer composite pipes of the pressfitting systems
¹⁾ Bending radius mm on the inside of the bend (EN 10255)
²⁾ Bending radius mm at the neutral axis of the bend (DVGW VP 632)
³⁾ 2 slide pieces Ø 75 mm (Art. No. 590111) required



REMS Swing

Single-hand tube bender

Practical single-hand tool for exact tube bending up to 90°. Ideal for on-site work. For trade and industry. For the building site and the workshop.

Soft copper pipes, also thin-walled	Ø 10–22 mm Ø 3/8–7/8" s ≤ 1 mm
Coated soft copper tubes	Ø 10–18 mm Ø 3/8–5/8" s ≤ 1 mm
Coated carbon steel pipes of pressfitting systems	Ø 12–18 mm
Soft precision steel tubes	Ø 10–18 mm s ≤ 1 mm
Multi-layer composite tubes	Ø 14–32 mm

REMS Swing – bending tubes where they are installed. Universally usable for many pipe types. Fast operation through quick-acting in-feed forward and release. Proven, reliable ratchet feed. Ideal also for coated tubes.

Universal use

For sanitary, heating, air conditioning, refrigerating and hydraulic applications. Also for copper thin-walled heating tubes according to EN 1057 and for tubes of pressfitting systems.

Cost advantage

Bender recovered after a few bends through savings on fittings. No costs for fittings, storage, procurement. Savings in soldering joints, pressing joints and working hours. Higher safety thanks to fewer pipe joints.

Design

Compact, job site-proven. Handy and light, only 1.3 kg. Can be used anywhere, free-hand, in confined areas. Simple, fast operation, e.g. bends Ø 22 mm in only 9 s. Quick-acting in-feed and release saves time and effort. Marked bending formers for exact bending. Crossover, swan-neck, reverse bends possible. Easy and rapid changing of bending formers.

Bending formers and sliding pieces

In high-strength, high-slide, glass-fibre reinforced polyamide. Application of bending formers, see table right.

Drive

Only 1 sturdy bender drive with proven, reliable ratchet feed for the complete work range up to Ø 32 mm. 1 universal crossbar, reversible according to the required tube size, with bending formers up to Ø 26 mm, 3/8". 1 crossbar with sliding pieces for Ø 32 mm. Device for reverse bends up to Ø 22 mm, 1/4".



German Quality Product

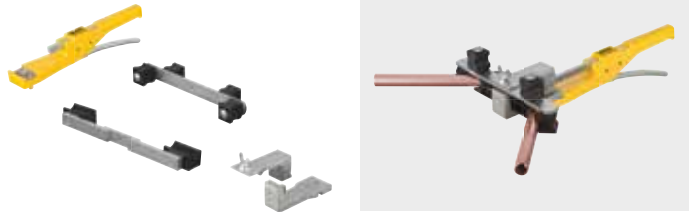

Accessories

Description	Art.-No.
Bender drive	153100
Universal back former carrier with back formers for Ø 10 – 26 mm, 3/8 – 7/8" pipes	153125
Back former carrier 32 with back formers for Ø 32 mm pipes	153115
Device for reverse bends on installed pipes	153140
Steel case with inlay	153265
Case with inlay	153270

Bending former for tubes Ø mm/inch	Bending radius ¹⁾ mm	suitable for					Art.-No.
		Cu	Cu-U	St-U	St	>	
10, 3/8	30	•					153155
12, 10 U, 1/2	36	•	•				153160
14, 12 U	50	•		•	•	•	153170
15, 12 U, 3/8	55	•	•		•		153175
16, 14 U	55	•	•		•	•	153180
17, 15 U	60			•		•	153185
18, 14 U, 15 U, 16 U, 3/4	72	•	•		•		153190
20, 18 U	79	•	•	•		•	153195
22, 18 U, 1/4	86	•	•				153200
25, 26	88					•	153205
32	128					•	153210

¹⁾ Bending radius mm at the neutral axis of the bend (DVGW GW 392).

- Cu: soft copper tubes, also thin-wall
- St-U: coated carbon steel pipes of the pressfitting systems EN 10305-3 (DIN 2394)
- St: soft precision steel pipes EN 10305-1, EN 10305-2, EN 10305-3 (DIN 2391–2394)
- U: coated
- V: multi-layer composite tubes of pressfitting systems

Supply format

REMS Swing Set. Single-hand tube bender Ø 10–32 mm, Ø 3/8–7/8", up to 90°. Soft copper tubes Ø 10–22 mm, Ø 3/8–7/8", s ≤ 1 mm, coated soft copper tubes Ø 10–18 mm, Ø 3/8–5/8", s ≤ 1 mm, coated carbon steel pipes of pressfitting systems Ø 12–18 mm, soft precision steel tubes Ø 10–18 mm, s ≤ 1 mm, composite tubes Ø 14–32 mm. Up to Ø 26 mm with bender drive, bending formers, universal crossbar with sliding pieces, in sturdy steel case/plastic case. Up to Ø 32 mm with bender drive, bending formers, 2 universal crossbars with sliding pieces, in sturdy plastic case.

Description mm	inch	Art.-No.
Set 12-15-18-22	1/2-5/8-3/4-7/8"	153025
Set 10-12-15-18-22	3/8-1/2-5/8-3/4-7/8"	153021
Set 12-14-16-18-22	1/2-3/4-7/8"	153020
Set 14-16-20-25/26		153026
Set 14-16-18-20-25/26		153022
Set 16-20-25/26-32		153029
Set Allround 22		
10-12-14-15-16-17-18-20-22	3/8-1/2-5/8-3/4-7/8"	153027
Set 16-18-20-25/26-32		153023
Set Allround 32		
10-12-14-15-16-17-18-20-22-25/26-32	3/8-1/2-5/8-3/4-7/8"	153028



REMS Curvo 50

Electric pipe and tube bender

Universal, compact electric tool for cold bending of pipes and tubes up to 90°. Can be used anywhere, without vice. For trade and industry. For the building site and the workshop.

Steel pipes EN 10255 (DIN 2440)	Ø ¼–1¼"
Hard, half-hard, soft copper tubes	Ø 10–42 mm
Thin-wall copper tubes	Ø 10–35 mm
Pipes of press fitting systems made of stainless steel	Ø 12–42 mm
Carbon steel, also coated	Ø 12–35 (28) mm
Multi-layer composite tubes	Ø 14–50 mm
Further materials, see REMS Curvo	

REMS Curvo 50 – wrinkle free bending of large pipes.

Universal use

For metalwork and in sanitary, heating, air conditioning, refrigeration and hydraulic applications. Specially suited for steel pipe EN 10255 (DIN 2440), pipe for press-fitting systems, for hard and half hard copper pipe and for thin-walled copper heating pipe according to EN 1057.

System advantage

Bending formers and back formers of REMS Curvo, REMS Akku-Curvo and REMS Sinus (page 117) also fit in the REMS Curvo 50 drive machine with adaptor block 10–40, support 10–40. Therefore simple, inexpensive stocking. No confusion possible.

Cost advantage

Bender cost recovered after a small number of bends. No costs for fittings, storage, procurement. Savings in soldering joints, pressing joints and working hours. Higher safety thanks to fewer pipe joints.

Design

Compact, handy electric tool with integral absorption of torque during bending. Can be used anywhere, anytime. No setting. Simple, effortless, fast working, e.g. 90° bends of steel pipe Ø 1¼" in only 37 s. Fast and creep speed operation for precise bending. Swan-neck, U-bends possible.

Bending formers and back formers

Optimum matching of bending former and back former guarantees material-compatible gliding without cracks and creases. Angle scale provided on each bending former and mark on the back former ensure precise bending. Rapid change of bending formers and back formers. Bending formers and back formers for different sizes, materials and bending radii. Bending formers and back formers REMS Curvo 50 (Ø 35 R 100, Ø 42 R 140, Ø 50 R 135, Ø 1" R 100, Ø 1¼" R 140): Form and pressure resistant bending formers in ductile iron and back formers in high-strength, high-slide glass-fibre reinforced polyamide.

Drive

Robust, maintenance-free gear. Final point safety in both directions through safety slipping clutch. Proven, powerful universal motor, 1000 W. Right and left-hand rotation. Stepless electronic safety switch for rapid and creep speed operation.

Bending lubricant

REMS bending spray ensures a permanent lubricating film for reducing energy expenditure and uniform bending. High-pressure-proof, acid-free. CFC-free, so ozone-harmless.

Supply format

REMS Curvo 50 Basic-Pack. Electric pipe and tube bender Ø 10–50 mm, up to 90°. Steel pipes EN 10255 Ø ¼–1¼", hard, half-hard and soft copper tubes, Ø 10–42 mm, thin-wall copper tubes Ø 10–35 mm, pipes of the press fitting systems made of stainless steel Ø 12–42 mm, carbon steel Ø 12–35 mm, carbon steel coated Ø 12–28 mm, multi-layer composite tubes Ø 14–50 mm and others. Drive unit with maintenance-free gear and safety slipping clutch, universal motor 230 V or 110 V, 50–60 Hz, 1000 W, stepless electronic safety switch, right and left-hand rotation. Adaptor block 35–50, Support 35–50, insert bolt. In sturdy carrying case.

Art.-No.
580110

Other voltages on request.

Accessories

Description	Art.-No.
Bending formers and back formers see page 117.	
REMS Curvo 50 drive unit	580100
Adaptor block 35–50, Support 35–50 , for bending formers and back formers Ø 35 R 100, Ø 42 R 140, Ø 50 R 135, Ø 1" R 100, Ø 1¼" R 140 (see page 117).	582110
Adaptor block 10–40, Support 10–40 , for bending formers and back formers REMS Curvo, REMS Akku-Curvo, REMS Sinus (see page 117).	582120
Insert bolt	582036
REMS bending spray , 400 ml	140120
Carrying case with practical handles	590160
Steel case with insert for each bending former and back former R 100 and R 135/R 140, 90°	586012



German Quality Product



Universal, compact electric tool for cold bending of pipes and tubes up to 180°. Can be used anywhere, without vice. For trade and industry. For the building site and the workshop.

Hard, half-hard, soft copper tubes also thin-wall	Ø 10–35 mm Ø 3/8–1 3/8"
Coated soft copper tubes, also thin-wall	Ø 10–18 mm
Pipes of press fitting systems made of stainless steel	Ø 12–28 mm
Carbon steel (coated)	Ø 12–28 mm
Soft precision steel tubes	Ø 10–28 mm
Steel pipes EN 10255 (DIN 2440)	Ø 1/4–3/4"
Electric conduit EN 50086	Ø 16–32 mm
Multi-layer composite tubes	Ø 14–40 mm

REMS Curvo – wrinkle-free bending. Universal for many pipe types. Instant use without setting. Fast and creep speed operation for precise bending. Rapid change of bending and back formers.

Universal use

For sanitary, heating, air conditioning, refrigerating and hydraulic applications. Specially suited for tubes of pressfitting systems, for hard and half-hard copper tubes and for thin-walled copper heating tubes according to EN 1057.

System advantage

Only one type of bending and back formers for REMS Curvo and REMS Sinus. Therefore simple, inexpensive stocking. No confusion possible.

Cost advantage

Bender cost recovered after a small number of bends. No costs for fittings, storage, procurement. Savings in soldering joints, pressing joints and working hours. Higher safety thanks to fewer pipe joints.

Design

Compact, handy electric tool with integral absorption of torque during bending. Super light, drive unit only 8 kg. Can be used anywhere, anytime. No setting. Simple, effortless, fast working, e.g. 90° bends, Ø 22 mm in only 6 s. Fast and creep speed operation for precise bending. Crossover, swan-neck, U-bends possible. Height adjustable machine support as accessory.

Bending formers and back formers

Form and pressure resistant, in high-strength, high-slide, glass-fibre reinforced polyamide. Optimum matching of bending former and back former guarantees material-compatible gliding without cracks and creases. Angle scale 0 to 180° provided on each bending former and mark on the back former ensure precise bending. Rapid change of bending formers and back formers. Bending formers and back formers for different sizes, materials and bending radii, see page 117.

Drive

Robust, maintenance-free gear. Final point safety in both directions through safety slipping clutch. Proven, powerful universal motor, 1000 W. Right and left-hand rotation. Stepless electronic safety switch for rapid and creep speed operation.

Bending lubricant

REMS bending spray ensures a permanent lubricating film for reducing energy expenditure and uniform bending. High-pressure-proof, acid-free, CFC-free, so ozone-harmless.



German Quality Product

Tested by electrosuisse >>





Basic-Pack

Supply format

REMS Curvo Set. Electric pipe and tube bender Ø 10–40 mm, Ø ¼–1½", up to 180°. Hard, half-hard and soft copper tubes, also thin-wall Ø 10–35 mm, Ø ¾–1½", coated soft copper tubes, also thin-wall Ø 10–18 mm, pipes of the press fitting systems made of stainless steel Ø 12–28 mm, carbon steel, also coated Ø 12–28 mm, soft precision steel tubes Ø 10–28 mm, steel pipes EN 10255 Ø ¼–¾", electric conduit EN 50086 Ø 16–32 mm, multi-layer composite tubes Ø 14–40 mm and others. Drive unit with maintenance-free gear and safety slipping clutch, universal motor 230 V or 110 V, 50–60 Hz, 1000 W, stepless electronic safety switch, right and left-hand rotation, insert bolt. Bending formers and back formers. In sturdy steel case.

Description	Art.-No.
Set 15-18-22	580026
Set 15-18-22-28 ¹⁾	580027
Set 15-18-22-28 ²⁾	580035
Set 12-15-18-22	580020
Set 12-15-18-22-28 ¹⁾	580033
Set 15-22-28 ¹⁾	580022
Set 17-20-24	580023
Set 12-14-16-18-22	580021
Set 12-14-16-18-22-28 ¹⁾	580031
Set 14-16-18-22-28 ¹⁾	580028
Set ¾-½-¾-¾-¾-¾"	580024
Set 16-20-26-32	580025
Set 16-20-25-32	580034
Set 20-25-32	580029
Set 32-40	580030
Basic-Pack (without bending and back formers)	580010

REMS Curvo Set delivered with the smaller radius bending and back former (except Art.-No. 580029 and 580030), see page 117.

¹⁾ Bending former and back former 28, ¾, R102, Art.-No. 581070, see page 117.

²⁾ Bending former and back former 28, ¾, R114, Art.-No. 581310, see page 117.



Accessories

Description	Art.-No.
Bending formers and back formers see page 117.	
REMS Curvo drive unit	580000
Insert bolt	582036
REMS bending spray , 400 ml	140120
Steel case with insert	586000
Machine support 3B , height adjustable, on tripod	586100
Machine support WB , height adjustable, for mounting on work bench	586150



3B



WB

REMS Akku-Curvo

Cordless tube bender

Universal, compact electric tool for cold bending of pipes up to 180°. Can be used anywhere, without vice. For trade and industry. For the building site and the workshop.

Hard, half-hard, soft copper tubes also thin-wall	Ø 10–28 mm Ø 3/8–1 1/8"
Coated soft copper tubes, also thin-wall	Ø 10–18 mm
Pipes of press fitting systems made of stainless steel	Ø 12–28 mm
Carbon steel, also coated	Ø 12–28 mm
Soft precision steel tubes	Ø 10–28 mm
Steel pipes EN 10255 (DIN 2440)	Ø 1/4–1/2"
Electric conduit EN 50086	Ø 16–25 mm
Multi-layer composite tubes	Ø 14–32 mm

REMS Akku-Curvo Li-Ion – wrinkle-free bending of pipes. Universal for many pipe types. Ready to use immediately without setting. Fast and creep speed with immediate stop for precise bending. Quick change of bending and back formers.

Universal use

For sanitary, heating, air conditioning, refrigerating and hydraulic applications. Mains independent. Specially suited for tubes of pressfitting systems, for hard and half-hard copper tubes and for thin-walled copper heating tubes according to EN 1057.

System advantage

Only one type of bending and back formers for REMS Akku-Curvo, REMS Curvo and REMS Sinus. Therefore simple, inexpensive stocking. No confusion possible.

Cost advantage

Bender cost recovered after a small number of bends. No costs for fittings, storage, procurement. Savings in soldering joints, pressing joints and working hours. Higher safety thanks to fewer pipe joints.

Design

Compact, handy electric tool with integral absorption of torque during bending. Super light, drive machine with battery pack weights only 8.6 kg. Electronic charging status check with low discharge protection. Proven D-shaped handle. Can be used anywhere, anytime. No setting. Simple, effortless, fast working, e.g. 90° bend Ø 22 mm only 7 s. Fast and creep speed with immediate stop for precise bending. Crossover, swan-neck, U-bends possible. Height adjustable machine support as accessory.

Bending formers and back formers

Form and pressure resistant, in high-strength, high-slide, glass-fibre reinforced polyamide. Optimum matching of bending former and back former guarantees material-compatible gliding without cracks and creases. Angle scale 0 to 180° provided on each bending former and mark on the back former ensure precise bending. Rapid change of bending formers and back formers. Bending formers and back formers for different sizes, materials and bending radii, see page 117.

Drive

Robust, maintenance-free gear. Final point safety in both directions through safety slipping clutch. Powerful battery motor 18 V, with large power reserve, 500 W output. Right and left-hand rotation. Stepless electronic safety switch for fast and creep speed, with immediate stop.

Li-Ion PLUS technology

Highly resistant Li-Ion 18 V battery with 3.0 Ah capacity, for long service life. Powerful and light. Total discharge and overload protection with single cell monitoring. Temperature monitoring during the charging process. Operating temperature range – 10 to + 60 °C. No memory effect for maximum battery power. Rapid charger for short charging times.

Bending lubricant

REMS bending spray ensures a permanent lubricating film for reducing energy expenditure and uniform bending. High-pressure-proof, acid-free. CFC-free, so ozone-harmless.



German Quality Product

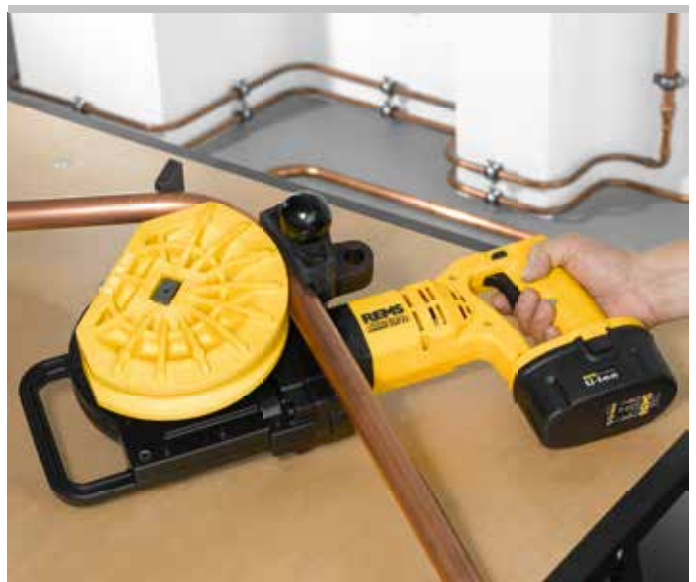



Basic-Pack

Supply format

REMS Akku-Curvo Li-Ion Set. Cordless tube bender Ø 10–32 mm, Ø ¼–1¼", to 180°. Hard, semi-hard, soft copper pipes, also thin-walled, Ø 10–28 mm, Ø ⅝–1⅝", soft jacketed copper pipes, also thin-walled, Ø 10–18 mm, pipes of the pressfitting systems made of stainless steel Ø 12–28 mm, carbon steel, also coated Ø 12–28 mm, soft precision steel pipes Ø 10–28 mm, steel pipes EN 10255 Ø ¼–½", electrical installation pipes EN 50086 Ø 16–25 mm, multi-layer composite tubes Ø 14–32 mm, among other things drive machine with D-shaped handle, maintenance-free gear with safely slipping clutch, powerful battery motor 18 V, stepless, electronic safety switch with immediate stop, right and left-hand rotation Battery Li-Ion 18 V, 3.0 Ah, rapid charger Li-Ion/Ni-Cd 230 V, 50–60 Hz, 50 W. Insert bolt. Bending and back formers. In sturdy steel case.

Description	Art.-No.
Set 15-18-22	580076
Set 15-18-22-28 ¹⁾	580077
Set 15-18-22-28 ²⁾	580073
Set 12-15-18-22	580070
Set 12-15-18-22-28 ¹⁾	580083
Set 15-22-28 ¹⁾	580072
Set 12-14-16-18-22	580071
Set 12-14-16-18-22-28 ¹⁾	580081
Set 14-16-18-22-28 ¹⁾	580078
Set ⅝-½-⅝-¾-⅞"	580074
Set 16-20-26-32	580075
Set 16-20-25-32	580084
Set 20-25-32	580079
Basic-Pack (without bending and back formers)	580012

REMS Akku-Curvo Set delivered with the smaller radius bending and back former (except Art.-No. 580079), see page 117.

¹⁾ Bending former and back former 28, ¾, R102, Art.-No. 581070, see page 117.

²⁾ Bending former and back former 28, ¾, R114, Art.-No. 581310, see page 117.



Accessories

Description	Art.-No.
Bending formers and back formers see page 117.	
REMS Akku-Curvo Li-Ion drive unit, without battery	580002
Battery Li-Ion 18 V, 3.0 Ah	565225
Rapid charger Li-Ion/Ni-Cd 230 V, 50–60 Hz, 65 W	571560
Insert bolt	582036
REMS bending spray, 400 ml	140120
Steel case with inlay	586015
Machine support 3B, height adjustable, on tripod	586100
Machine support WB, height adjustable, for mounting on work bench	586150

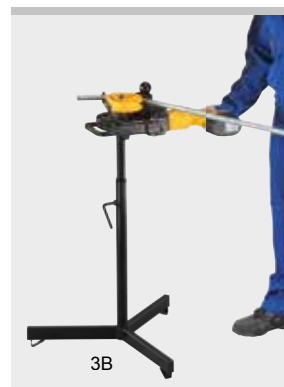

3B

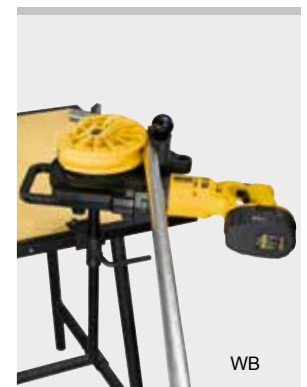

WB

Universal, robust hand tool for cold bending up to 180°. Can be used anywhere. For trade and industry. For the building site and the workshop.

Hard, half-hard, soft copper tubes, also thin-wall	Ø 10–22 mm Ø 3/8–7/8"
Coated soft copper tubes, also thin-wall	Ø 10–18 mm
Pipes of press fitting systems made of stainless steel, carbon steel (coated)	Ø 12–18 mm
Carbon steel	Ø 12–22 mm
Soft precision steel tubes	Ø 10–20 mm
Electric conduit EN 50086	Ø 16–20 mm
Multi-layer composite tubes	Ø 14–32 mm

REMS Sinus – wrinkle-free bending.
Universal for many tubes. Easy bending through long lever arms. Selectable lever positioning ensures optimum bending position and power transmission. Only one type of bending and back formers for REMS Sinus and REMS Curvo.

Universal use

For sanitary, heating, air conditioning, refrigerating and hydraulic applications. Specially suited for tubes of pressfitting systems, for hard and half-hard copper tubes and for thin-walled copper heating tubes according to EN 1057.

System advantage

Only one type of bending and back formers for REMS Sinus and REMS Curvo. Therefore simple, inexpensive stocking. No confusion possible.

Cost advantage

Bender cost recovered after a small number of bends. No costs for fittings, storage, procurement. Savings in soldering joints, pressing joints and working hours. Higher safety thanks to fewer pipe joints.

Design

Compact, handy unit of bender drive and bending tools. Can be used anywhere, in parallel vice or free hand as double-hand-bender. Easy bending through long lever arms. Selectable lever positioning ensures optimum bending position and power transmission. Robust design, bender drive in hardened steel for high stress conditions. Simple and rapid changing of bending and back formers. Crossover, swan-neck and U-bends possible.

Bending formers and back formers

For different pipe sizes, materials and bending radii, see page 117.

Bending lubricant

REMS bending spray ensures a permanent lubricating film for reducing energy expenditure and for uniform bending. High-pressure-proof, acid-free. CFC-free, so ozone-harmless.

Supply format

REMS Sinus Set. Hand tube bender Ø 10–32 mm, Ø 3/8–7/8", up to 180°. Hard, half-hard, soft copper tubes, also thin-wall Ø 10–22 mm, Ø 3/8–7/8", coated soft copper tubes, also thin-wall Ø 10–18 mm, pipes of the press fitting systems made of stainless steel, carbon steel (coated) Ø 12–18 mm, soft precision steel tubes Ø 10–22 mm, soft precision steel tubes, Ø 10–20 mm, electric conduit EN 50086, Ø 16–20 mm, multi-layer composite tubes Ø 14–32 mm and others. Bender drive, insert bolt. Bending formers and back formers. REMS bending spray. In sturdy steel case.

Description	Art.-No.
Set 15-18-22	154001
Set 14-16-18	154002
Set 12-15-18-22	154003
Set 10-12-14-16-18-22	154004
Basic-Pack (without bending and back formers and bending spray)	154010

REMS Sinus Set is delivered with bending formers and back formers of the smaller radius, see page 117.

Accessories

Description	Art.-No.
Bending and back formers see page 117.	
Insert bolt	582036
REMS Curvo drive unit	580000
REMS Sinus bender drive	154000
REMS bending spray , 400 ml	140120
Steel case with inlay	154160

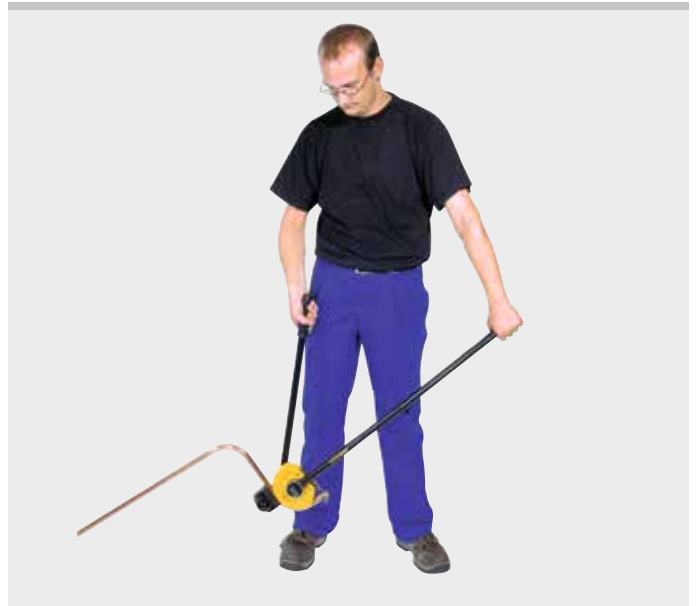

German Quality Product



Bending formers and back formers

Accessories for REMS Curvo 50,
REMS Curvo and REMS Sinus

Bending formers and back formers, 180°, form and pressure resistant, in high-strength, high-slide, glass-fibre reinforced polyamide 90° (Ø 35 R 100, Ø 42 R 140, Ø 50 R 135, Ø 1" R 100, Ø 1¼" R 140). Optimum matching of bending former and back former guarantees material-compatible gliding without cracks and creases. Angle scale provided on each bending former and mark on the back former ensure precise bending. Rapid change of bending formers and back formers.



Bending former and back former for pipes Ø mm/inch O.D.	R mm	X mm	Cu		Cu-U		St 10217		St 10305-U		St 10305		St 10255		St 50086		V		Art.-No.				
			REMS Sinus	REMS Curvo	REMS Akku-Curvo	REMS Curvo 50	REMS Sinus	REMS Curvo	REMS Akku-Curvo	REMS Curvo 50	REMS Sinus	REMS Curvo	REMS Akku-Curvo	REMS Curvo 50	REMS Sinus	REMS Curvo	REMS Akku-Curvo	REMS Curvo 50		REMS Sinus	REMS Curvo	REMS Akku-Curvo	REMS Curvo 50
			REMS Sinus	REMS Curvo	REMS Akku-Curvo	REMS Curvo 50	REMS Sinus	REMS Curvo	REMS Akku-Curvo	REMS Curvo 50	REMS Sinus	REMS Curvo	REMS Akku-Curvo	REMS Curvo 50	REMS Sinus	REMS Curvo	REMS Akku-Curvo	REMS Curvo 50		REMS Sinus	REMS Curvo	REMS Akku-Curvo	REMS Curvo 50
10	40	45	•	•	•	•	•	•	•	•	•	•	•	•	•	•	•	•	•	•	581400		
12	45	49	•	•	•	•	•	•	•	•	•	•	•	•	•	•	•	•	•	•	581410		
14, 10 U, ¼ (DN 6)	50	53	•	•	•	•	•	•	•	•	•	•	•	•	•	•	•	•	•	•	581420		
15, 12 U	55	56	•	•	•	•	•	•	•	•	•	•	•	•	•	•	•	•	•	•	581430		
16, 12 U	60	62	•	•	•	•	•	•	•	•	•	•	•	•	•	•	•	•	•	•	581440		
17, 15 U	56	60	•	•	•	•	•	•	•	•	•	•	•	•	•	•	•	•	•	•	581110		
18, 14 U, 15 U, ⅜ (DN 10)	70	75	•	•	•	•	•	•	•	•	•	•	•	•	•	•	•	•	•	•	581450		
20, 16 U, 18 U	75	80	•	•	•	•	•	•	•	•	•	•	•	•	•	•	•	•	•	•	581080		
22, 18 U, ½ (DN 15)	77	81	•	•	•	•	•	•	•	•	•	•	•	•	•	•	•	•	•	•	581460		
22, 18 U, ½ (DN 15)	88	91	•	•	•	•	•	•	•	•	•	•	•	•	•	•	•	•	•	•	581470		
24, 22 U	75	85	•	•	•	•	•	•	•	•	•	•	•	•	•	•	•	•	•	•	581130		
25	98	103	•	•	•	•	•	•	•	•	•	•	•	•	•	•	•	•	•	•	581180		
26	98	108	•	•	•	•	•	•	•	•	•	•	•	•	•	•	•	•	•	•	581270		
28, ¼ (DN 20)	102 ¹⁾	108	•	•	•	•	•	•	•	•	•	•	•	•	•	•	•	•	•	•	581070		
28, ¼ (DN 20)	102	110	•	•	•	•	•	•	•	•	•	•	•	•	•	•	•	•	•	•	581260		
28, ¼ (DN 20)	114	120	•	•	•	•	•	•	•	•	•	•	•	•	•	•	•	•	•	•	581310		
30, 28 U	98 ¹⁾	105	•	•	•	•	•	•	•	•	•	•	•	•	•	•	•	•	•	•	581150		
32	98	110	•	•	•	•	•	•	•	•	•	•	•	•	•	•	•	•	•	•	581280		
32	114	121	•	•	•	•	•	•	•	•	•	•	•	•	•	•	•	•	•	•	581320		
35	100	105	•	•	•	•	•	•	•	•	•	•	•	•	•	•	•	•	•	•	581500		
35	140	150	•	•	•	•	•	•	•	•	•	•	•	•	•	•	•	•	•	•	581350		
40	140	148	•	•	•	•	•	•	•	•	•	•	•	•	•	•	•	•	•	•	581330		
42	140	155	•	•	•	•	•	•	•	•	•	•	•	•	•	•	•	•	•	•	581510		
50	135	143	•	•	•	•	•	•	•	•	•	•	•	•	•	•	•	•	•	•	581540		
¾" (9,5 mm)	43	48	•	•	•	•	•	•	•	•	•	•	•	•	•	•	•	•	•	•	581200		
½" (12,7 mm)	52	60	•	•	•	•	•	•	•	•	•	•	•	•	•	•	•	•	•	•	581210		
⅝" (15,9 mm)	63	70	•	•	•	•	•	•	•	•	•	•	•	•	•	•	•	•	•	•	581220		
¾" (19,1 mm)	75	82	•	•	•	•	•	•	•	•	•	•	•	•	•	•	•	•	•	•	581230		
⅞" (22,2 mm)	98	107	•	•	•	•	•	•	•	•	•	•	•	•	•	•	•	•	•	•	581240		
1" (33,7 mm)	100	105	•	•	•	•	•	•	•	•	•	•	•	•	•	•	•	•	•	•	581520		
1" (25,4 mm)	101	112	•	•	•	•	•	•	•	•	•	•	•	•	•	•	•	•	•	•	581370		
1⅛" (28,6 mm)	102	110	•	•	•	•	•	•	•	•	•	•	•	•	•	•	•	•	•	•	581260		
1⅛" (28,6 mm)	115	117	•	•	•	•	•	•	•	•	•	•	•	•	•	•	•	•	•	•	581380		
1¼" (31,8 mm)	114	123	•	•	•	•	•	•	•	•	•	•	•	•	•	•	•	•	•	•	581320		
1¼" (31,8 mm)	133	145	•	•	•	•	•	•	•	•	•	•	•	•	•	•	•	•	•	•	581390		
1¼" (42,4 mm)	140	150	•	•	•	•	•	•	•	•	•	•	•	•	•	•	•	•	•	•	581530		
1⅝" (34,9 mm)	140	150	•	•	•	•	•	•	•	•	•	•	•	•	•	•	•	•	•	•	581350		

- R mm Bending radius mm at the neutral axis of the bend (DVGW GW 392)
- X mm Correction dimension mm
- ¹⁾ According to DVGW work sheet GW 392 minimum bending radius of 114 mm required for copper tubes Ø 28 mm. Wall thickness ≥ 0,9 mm
- ²⁾ Adaptor block 10–40, support 10–40 (Art.-No. 582120) necessary.
- ³⁾ Adaptor block 35–50, support 35–50 (Art.-No. 582110) necessary.
- Cu: hard, half-hard, soft copper tubes, also thin-wall, EN 1057
- St 10217: stainless steel pipes of the pressfitting systems EN 10217-7 (DIN 2463)
- St 10305-U: coated carbon steel pipes of the pressfitting systems EN 10305-3 (DIN 2394)
- St 10305: soft precision steel pipes EN 10305-1, EN 10305-2, EN 10305-3 (DIN 2391–2394), carbon steel pipes EN 10305-3 (DIN 2394)
- St 10255: Steel pipes (threaded pipes) EN 10255 (DIN 2440)
- St 50086: Electrical installation pipes DIN EN 50086
- U: coated
- V: multi-layer composite tubes of pressfitting systems

Bending to size

If a bend is required at a certain point on the pipe, a length correction must be made to suit the pipe size. For a 90° bend, the correction dimension X given in Fig. 1 must be taken into account. The set dimension L must be reduced by the amount X here. If, e.g., the dimension L for pipe size 22 is 400 mm and a bend with a bending radius of 77 mm is to be made, the dimension line should be marked on the pipe at 319 mm. This line is then – as shown in Fig. 1 – to be aligned with the 0-mark on the bending former.

No cracks or wrinkles shall occur during professional cold bending. Pipe qualities and sizes which do not guarantee this are not suited to be bent with REMS Sinus, REMS Curvo, REMS Curvo 50 and REMS Akku-Curvo.

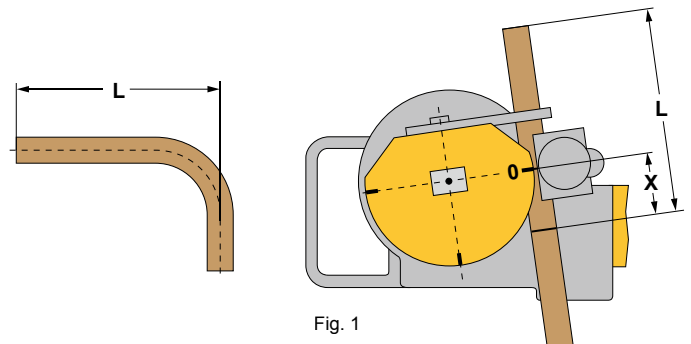

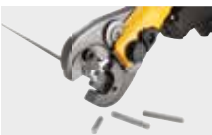













Fig. 1



REMS

Radial Press Jointing

	Cordless radial press Mini	122
	Pressing tongs Mini	124
	Cropping tongs Mini	137
	Manual radial press	138
	Electric radial press	139
	Electro-hydraulic radial presses	140
	Cordless radial presses	142
	Pressing tongs / pressing rings	144
   	Hold-Harmless and Indemnification Agreement	162
	Cropping tongs	163
	Cable shears	163



3.1 million!

REMS will have produced more than 3.1 million pressing tongs by the end of 2015. This success confirms the leading role of REMS in press-jointing technology.



REMS Mini-Press ACC

Cordless radial press with automatic circuit control

Universal, super handy electric tool with automatic circuit control for producing pipe pressing joints for all common pressfitting systems. For battery and corded operation.

Pipe pressing joints Ø 10–40 mm
Ø 3/8–1 1/4

Complete range of REMS pressing tongs Mini for all common pressfitting systems, see page 124–136.

REMS Mini-Press ACC Li-Ion – universal up to Ø 40 mm. Super light, super small, super handy. With automatic circuit control. Secure crimping in seconds. Automatic locking of the pressing tongs.

Pressing tongs for all common systems

Complete assortment of REMS pressing tongs Mini for all common pressfitting systems (page 124–136). High-compression pressing tongs in forged and specially hardened steel. Pressing contours of REMS pressing tongs are system-specific and correspond to the respective pressfitting system. Thus perfect system-conformity, safe press jointing.

Very compact design and low weight of the REMS Mini pressing tongs due to special arrangement of the pressing tongs connection (**Patent EP 1 952 948**). Recesses in the pressing jaws for safe guidance of the connecting plate for offset-free pressing (**Patent EP 2 347 862**).

Design

Super light, super small, super handy. Drive unit with battery only 2.4 kg. Drive unit with pressing tongs V 22 only 33 cm long. Works anywhere, free-hand, overhead, also in particularly tight areas. Optimum weight distribution for single-hand operation. Ergonomically designed housing. Integrated LED work light for illuminating the work place. Swivelling pressing tongs seat. Secure seating of pressing tongs by automatic locking. For battery and corded operation. Electronic charging status check with flat battery protection and charging status indicator with 2-coloured LED.

Pressing operation by touch-control with ACC

For reliable service, operating and functional safety. Automatic retraction after completion of pressing operation (automatic circuit control).

Drive

Enormous thrust and pressing force for fast and perfect press jointing. Powerful electro-hydraulic drive with powerful battery motor 14.4 V, 380 W output, robust planetary gear, eccentric reciprocating pump and compact high power hydraulic system. Safety tip switch.

Battery or mains operation

Li-Ion PLUS technology. Highly resistant Li-Ion 14.4 V battery with 1.5 or 3.0 Ah capacity for long service life. Powerful and light. Li-Ion 14.4 V, 3.0 Ah battery for approx. 330 pressings Viega Profipress DN 15 per battery charge. Total discharge and overload protection with single cell monitoring. Temperature monitoring during the charging process. Operating temperature range –10 to +60 °C. No memory effect for maximum battery power. Rapid charger for short charging times. Li-Ion 230 V voltage supply for mains operation instead of Li-Ion battery 14.4 V, as accessory.

Supply format

REMS Mini-Press ACC Li-Ion Basic-Pack. Cordless radial press with automatic circuit control for producing pipe pressing joints Ø 10–40 mm, Ø 3/8–1 1/4". For operating with REMS pressing tongs Mini. Swivelling pressing tongs seat with automatic locking. Electro-hydraulic drive with powerful battery motor 14.4 V, 380 W, robust planetary gear, eccentric reciprocating pump and compact high power hydraulic system. Safety tip switch. Integrated LED work light. Battery Li-Ion 14.4 V, 1.5 Ah, rapid charger Li-Ion/Ni-Cd 230 V or 110 V, 50–60 Hz, 65 W. In sturdy steel case.

	Art.-No.
	578012

Other voltages on request.

Accessories

Description	Art.-No.
REMS pressing tongs Mini see page 124–136.	
REMS cropping tongs Mini for threaded rods see page 137.	
REMS Mini-Press ACC Li-Ion drive unit, without battery	578001
Battery Li-Ion 14.4 V, 1.5 Ah	571545
Battery Li-Ion 14.4 V, 3.0 Ah	571555
Rapid charger Li-Ion/Ni-Cd 230 V, 50–60 Hz, 65 W	571560
Voltage supply Li-Ion 230 V for mains operation instead of battery Li-Ion 14.4 V.	571565
Steel case with inlay	578290
REMS cordless LED lamp see page 95	175200



German Quality Product

Tested by electrosuisse >>>



REMS Mini-Press 22V ACC

Cordless radial press with automatic circuit control

Universal, super handy electric tool with automatic circuit control for producing pipe pressing joints for all common pressfitting systems. Li-Ion 22V Technology.

Pipe pressing joints \varnothing 10–40 mm
 \varnothing $\frac{3}{8}$ – $1\frac{1}{4}$ "

Complete range of REMS pressing tongs Mini for all common pressfitting systems, see page 124–136.

REMS Mini-Press ACC Li-Ion – universal up to \varnothing 40 mm. Super light, super small, super handy, ultra fast. Pressing under 4 s. Automatic pressing process. With automatic circuit control. Li-Ion 22V Technology for 50% more pressings²⁾.

Pressing tongs for all common systems

Complete assortment of REMS pressing tongs Mini for all common pressfitting systems (page 124–136). High-compression pressing tongs in forged and specially hardened steel. Pressing contours of REMS pressing tongs are system-specific and correspond to the respective pressfitting system. Thus perfect system-conformity, safe press jointing.

Very compact design and low weight of the REMS Mini pressing tongs due to special arrangement of the pressing tongs connection (**Patent EP 1 952 948**). Recesses in the pressing jaws for safe guidance of the connecting plate for offset-free pressing (**Patent EP 2 347 862**).

Design

Super light, super small, super handy. Drive unit with battery only 2.5 kg. Drive unit with pressing tongs V 15 only 31 cm long. Works anywhere, free-hand, overhead, also in particularly tight areas. Optimum weight distribution for single-hand operation. Drive unit with inserted pressing tongs can be put down on the battery ready to pick up. Ergonomically designed housing with soft grip. Integrated LED work light for illuminating the work place. Swivelling pressing tongs seat, rotation angle > 360°. Secure seating of pressing tongs by automatic locking. Electronic charging status check with flat battery protection and charging status indicator with 2-coloured LED.

Pressing operation with ACC

For reliable service, operating and functional safety. Automatic retraction after completion of pressing operation (automatic circuit control). Ultra fast Pressing under 4 s.

Drive

Enormous thrust and pressing force for fast and perfect press jointing. Powerful electro-hydraulic drive with powerful battery motor 21.6 V, 380 W output, robust planetary gear, eccentric reciprocating pump and compact high power hydraulic system. Inching switch, emergency stop.

Li-Ion 22V Technology

Highly resistant Li-Ion 21.6V batteries with 1.5 or 2.5Ah capacity for long service life. Powerful and light. Li-Ion 21.6V batteries for 50% more pressings²⁾ than Li-Ion 14.4V batteries. Li-Ion 21.6V, 1.5Ah batteries for approx. 250 pressings Viega Profipress DN 15 per battery charge. Li-Ion 21.6V, 2.5Ah battery for approx. 390 pressings Viega Profipress DN 15 per battery charge. Graduated charging state display with coloured LED. Total discharge and overload protection with single cell monitoring. Temperature monitoring during the charging process. Operating temperature range –10 to +60 °C. No memory effect for maximum battery power. Rapid charger for short charging times.

Scope of Supply

REMS Mini-Press 22V ACC Li-Ion Basic-Pack. Cordless radial press with automatic circuit control for producing pipe pressing joints \varnothing 10–40 mm, \varnothing $\frac{3}{8}$ – $1\frac{1}{4}$ ". For operating with REMS pressing tongs Mini. Swivelling pressing tongs seat with automatic locking. Electro-hydraulic drive with powerful battery motor 21.6 V, 380 W, robust planetary gear, eccentric reciprocating pump and compact high power hydraulic system. Inching switch, emergency stop. Integrated LED work light. Battery Li-Ion 21.6 V, 1.5 Ah, rapid charger Li-Ion 230 V or 110 V, 50–60 Hz, 70 W. In sturdy steel case.

	Art.-No.
	578010

Other voltages on request.

Accessories

Description	Art.-No.
REMS pressing tongs Mini see page 124–136.	
REMS cropping tongs Mini for threaded rods see page 137.	
REMS Mini-Press 22V ACC Li-Ion drive unit, without battery	578002
Battery Li-Ion 21.6V, 1.5Ah	571570
Battery Li-Ion 21.6V, 2.5Ah	571571
Rapid charger Li-Ion 230V, 50–60Hz, 70W	571575
Steel case with inlay	578290



German Quality Product



Tested by electrosuisse >>>



REMS pressing tongs Mini REMS pressing rings

Accessories for REMS Mini-Press ACC and
REMS Mini-Press 22 V ACC

for all common pressfitting systems

German Quality Product



Patent EP 1 952 948
Patent EP 2 347 862

REMS pressing tongs Mini/ REMS pressing rings

Very compact design and low weight of the REMS Mini pressing tongs due to special arrangement of the pressing tongs connection (Patent EP 1 952 948). Recesses in the pressing jaws for safe guidance of the connecting plate for offset-free pressing (Patent EP 2 347 862).

High-compression pressing tongs/pressing rings in forged and specially hardened steel. Pressing contours of REMS pressing tongs/pressing rings are system-specific and correspond with the respective pressfitting system. Thus perfect system-conformity, safe press jointing. Pressing jaws of pressing tongs/pressing rings manufactured on CNC production centres ensure high-precision machining of pressing contour. Hence far closer tolerances compared to as cast pressing contour.

Driven by REMS Mini-Press ACC and REMS Mini-Press 22 V ACC. Read and follow the installation and assembly instructions of the system provider/manufacturer.

Select pressing tongs Mini/ pressing rings yourself!

Search for the required pressfitting system in the opposite table and select the correct pressing tongs size/pressing rings size. Please note that pressfitting systems for gas installation may only be pressed with the REMS pressing tongs Mini/pressing rings which are highlighted in yellow in the table.

Traceability according to EN 1775:2007

REMS pressing tongs Mini with pressing contour F, M, V, SA, B, RN and UP have worked a specific marking into the pressing contour which leaves a lasting impression on the pressed fitting after the pressing process. This enables the user to check again whether the most suitable pressing tongs have been used to make the pressfit connection even after the pressing process.

With this traceability REMS fulfils the recommendations of the European standard EN 1775:2007 for the installation of pressfitting systems for gas.

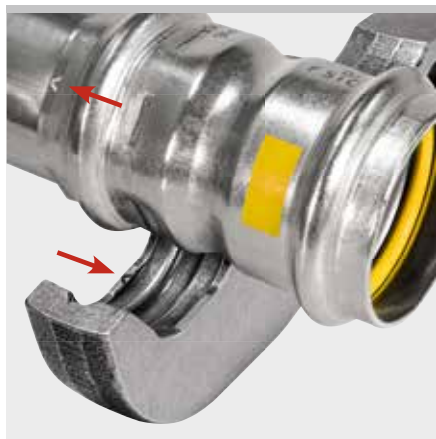

Example REMS pressing tongs Mini V: "V" imprint on pressed fitting for traceability according to EN 1775:2007

Hold-Harmless and Indemnification Agreement

See page 162.

Confirmation of suitability

See page 161.



Pressing contours

ACz		
B		
F		
G		
H		
HA		
HE		
K		
KI		
M		
MT		
RFz		
RN		
SA		
TH		
U		
UP		
US		
V		
VAU		
VIC		
VP		
VRX		
VX		
VUS		

REMS pressing tongs Mini REMS pressing rings

Accessories for REMS Mini-Press ACC and REMS Mini-Press 22 V ACC

System	Pressing contour	Art.-No.	System	Pressing contour	Art.-No.	System	Pressing contour	Art.-No.
AC-FIX PRESS (Global Piping Systems)	H 12	578396	ALB	TH 16	578352	BARBI	H 14	578398
	H 16	578400	Sistema Multicapa	TH 18	578356	MULTIPEX	H 16	578400
	H 20	578406		TH 20	578358	(Industrial Blansol)	H 18	578404
	H 25	578408		TH 26	578362	H 20	578406	
	H 32	578412		TH 32	578364	H 25	578408	
	RFz 12	578490		TH 40	578624	H 26	578410	
	RFz 16	578492		H 16	578400	H 32	578412	
	RFz 20	578494		H 18	578404	RFz 16	578492	
	RFz 25	578496		H 20	578406	RFz 18	578638	
	RFz 32	578498		H 26	578410	RFz 20	578494	
	U 16	578374		H 32	578412	RFz 25	578496	
	U 20	578378	U 16	578374	RFz 32	578498		
	U 25	578380	U 18	578376	TH 16	578352		
	U 32	578382	U 20	578378	TH 18	578356		
	VX 16	578552	C 26	578392	TH 20	578358		
	VX 20	578554	U 32	578382	TH 25	578360		
	AC-FIX PRESS-MULTI (Global Piping Systems)	H 16	578400	U 40	578386	TH 26	578362	
		H 18	578404	APE Serie AP	B 16	578468	TH 32	578364
		H 20	578406	B 20	578472	TH 40	578624	
		H 25	578408	B 26	578474	U 16	578374	
		H 32	578412	B 32	578476	U 18	578376	
RFz 16		578492	H 16	578400	U 20	578378		
RFz 20		578494	H 20	578406	U 25	578380		
RFz 25		578496	H 26	578410	U 32	578382		
RFz 32		578498	H 32	578412	U 40	578386		
U 16		578374	TH 16	578352	BEGETUBE/ IVAR	B 14	578466	
U 18		578376	TH 18	578356	B 16	578468		
U 20	578378	TH 20	578358	B 18	578470			
U 25	578380	TH 26	578362	B 20	578472			
U 32	578382	TH 32	578364	B 26	578474			
ACOME MT	ACz 12	578608	TH 40	578624	B 32	578476		
	ACz 16	578610	U 16	578374	H 16	578400		
	ACz 20	578612	U 18	578376	H 20	578406		
	ACz 25	578614	U 20	578378	H 26	578410		
	AHLSELL A-press elförzinkad	M 12	578310	U 25	578380	H 32	578412	
		M 15	578312	U 32	578382	U 16	578374	
		M 18	578314	TH 20	578358	U 18	578376	
		M 22	578316	TH 26	578362	U 20	578378	
		M 28	578318	TH 32	578364	U 25	578380	
		M 35	578390	U 16	578374	U 32	578382	
		M 12 45° (PR-2B) ³⁾	574520	U 40	578386	Brass Form Press Form Pex	H 16	578400
M 15 45° (PR-2B) ³⁾		574522	APE Serie AP Gas	TH 16	578352	H 18	578404	
M 18 45° (PR-2B) ³⁾		574524	TH 20	578358	H 20	578406		
M 22 45° (PR-2B) ³⁾		574526	TH 26	578362	H 25	578408		
M 28 45° (PR-2B) ³⁾		574528	TH 32	578364	U 25	578410		
M 35 45° (PR-2B) ³⁾		574530	U 16	578374	U 32	578412		
AHLSELL A-press koppar		V 12	578324	U 18	578376	U 40	578414	
	V 15	578328	U 20	578378	Brass Form Press Form Pex-Al-Pex	H 16	578400	
	V 18	578332	U 25	578380	H 18	578404		
	V 22	578334	C 26	578392	H 20	578406		
	V 28	578336	U 32	578382	TH 16	578352		
	V 35	578604	ASCHL NIR	M 15	578312	TH 18	578356	
	V 12 45° (PR-2B) ³⁾	574502	M 18	578314	M 22	578316		
	V 15 45° (PR-2B) ³⁾	574504	M 22	578316	M 28	578318		
	V 18 45° (PR-2B) ³⁾	574506	M 28	578318	M 35	578390		
	V 22 45° (PR-2B) ³⁾	574508	M 35	578390	M 15 45° (PR-2B) ³⁾	574522		
	V 28 45° (PR-2B) ³⁾	574510	M 15 45° (PR-2B) ³⁾	574522	M 18 45° (PR-2B) ³⁾	574524		
	V 35 45° (PR-2B) ³⁾	574512	M 18 45° (PR-2B) ³⁾	574524	M 22 45° (PR-2B) ³⁾	574526		
	AHLSELL A-press rostfritt	M 15	578312	M 22 45° (PR-2B) ³⁾	574526	M 28 45° (PR-2B) ³⁾	574528	
M 18		578314	M 28 45° (PR-2B) ³⁾	574528	M 35 45° (PR-2B) ³⁾	574530		
M 22		578316	M 35 45° (PR-2B) ³⁾	574530	ASTM F 1807 (Fittings with Copper Crimp Ring for PEX tubing)	US 3/4"	578534	
M 28		578318	Bampi BALPEX (serie MP)	TH 14	578348	US 1/2"	578536	
M 35		578390	TH 16	578352	US 3/4"	578538		
M 15 45° (PR-2B) ³⁾		574522	TH 18	578356	US 1"	578540		
M 18 45° (PR-2B) ³⁾		574524	TH 20	578358	TH 14	578348		
M 22 45° (PR-2B) ³⁾		574526	TH 26	578362	TH 16	578352		
M 28 45° (PR-2B) ³⁾		574528	TH 32	578364	TH 18	578356		
M 35 45° (PR-2B) ³⁾		574530	TH 40	578624	TH 20	578358		
AIRBEL PRESSCLIM		M 15	578312	Bampi BALPEX Gas	TH 16	578352	TH 26	578362
		M 18	578314	TH 20	578358	TH 32	578364	
		M 22	578316	TH 26	578362	TH 40	578624	
	M 28	578318	TH 32	578364	U 16	578374		
	M 35	578390	TH 40	578624	U 18	578376		
	M 15 45° (PR-2B) ³⁾	574522	BARBI	H 12	578396	U 20	578378	
	M 18 45° (PR-2B) ³⁾	574524	EASYPRESS	H 16	578400	U 25	578380	
	M 22 45° (PR-2B) ³⁾	574526	(Industrial Blansol)	H 20	578406	U 32	578382	
	M 28 45° (PR-2B) ³⁾	574528	H 25	578408	Business Key MT-PRESS (inox)	M 15	578312	
	M 35 45° (PR-2B) ³⁾	574530	H 32	578412	M 18	578314		
	AIRBEL SERTINOX	M 15	578312	RFz 12	578490	M 22	578316	
		M 18	578314	RFz 16	578492	M 28	578318	
		M 22	578316	RFz 20	578494	M 35	578390	
M 28		578318	RFz 25	578496	M 15 45° (PR-2B) ³⁾	574522		
M 35		578390	RFz 32	578498	M 18 45° (PR-2B) ³⁾	574524		
M 15 45° (PR-2B) ³⁾		574522	CHIALI	TH 16	578352	M 22 45° (PR-2B) ³⁾	574526	
M 18 45° (PR-2B) ³⁾		574524	CHIALIPEX	TH 20	578358	M 28 45° (PR-2B) ³⁾	574528	
M 22 45° (PR-2B) ³⁾		574526	TH 26	578362	M 35 45° (PR-2B) ³⁾	574530		
M 28 45° (PR-2B) ³⁾		574528	TH 32	578364	Cello Products Press	VUS 1/2" (OD 15,9 mm)	578566	
M 35 45° (PR-2B) ³⁾		574530	TH 40	578624	VUS 3/4" (OD 22,2 mm)	578568		
					VUS 1" (OD 28,6 mm)	578570		
					VUS 1 1/4" (OD 34,9 mm)	578606		

Pressfitting systems for gas installations must only be pressed with REMS pressing tongs Mini/pressing rings which are highlighted in yellow. Observe the national regulations.

¹⁾ Only pressing tongs from designation "108" (1st quarter of 2008), "208" (2nd quarter of 2008) etc. can be used. The designation is stamped on every pressing jaw.

²⁾ For taking suitable pressing inserts.

³⁾ Adapter tongs are required for driving pressing rings (PR), see page 136.

The suitability of REMS pressing tools for pressfitting systems: Date 09.10.2015. For the updated situation regarding suitability status check our website:

www.rems.de → Downloads → Product catalogues, brochures → REMS Catalogue.

Pressing tongs for additional pressfitting systems on request.

System	Pressing contour	Art.-No.
Climatex	TH 14	578348
Clima Therm	TH 16	578352
	TH 18	578356
	TH 20	578358
	TH 26	578362
	TH 32	578364
Climatrix	H 16	578400
Climatrix Rhinopex	H 20	578406
	U 16	578374
	U 20	578378
	TH 14	578348
	TH 16	578352
	TH 18	578356
	TH 20	578358
	TH 26	578362
	TH 32	578364
ClouSet	TH 16	578352
	TH 18	578356
	TH 20	578358
COMAP	V 12	578324
SudoPress Carbon	V 15	578328
	V 18	578332
	V 22	578334
	V 28	578336
	V 35	578604
Comap	V 12	578324
SudoPress Copper	V 14	578326
	V 15	578328
	V 16	578330
	V 18	578332
	V 22	578334
	V 28	578336
	V 35	578604
Comap SudoPress	V 14	578326
Copper Gas	V 15	578328
	V 16	578330
	V 18	578332
	V 22	578334
	V 28	578336
	V 35	578604
COMAP	V 14	578326
SudoPress	V 15	578328
Copper Solar	V 16	578330
	V 18	578332
	V 22	578334
COMAP	V 15	578328
SudoPress	V 18	578332
Stainless	V 22	578334
	V 28	578336
	V 35	578604
Comap	RFz 12	578490
PexPress	RFz 16	578492
	RFz 20	578494
	RFz 25	578496
Comap	TH 14	578348
SkinPress	TH 16	578352
	TH 18	578356
	TH 20	578358
	TH 26	578362
	THL 32	578368
	TH 40	578624
Comap	TH 16	578352
SkinPress Gas	TH 20	578358
	TH 26	578362
	THL 32	578368
Comap	TH 16	578352
SkinPress PPSU	TH 20	578358
	TH 26	578362
	THL 32	578368
COMAP	M 12	578310
Xpress Carbon	M 15	578312
	M 18 ¹⁾	578314
	M 22	578316
	M 28 ¹⁾	578318
	M 35	578390
	M 12 45° (PR-2B) ³⁾	574520
	M 15 45° (PR-2B) ³⁾	574522
	M 18 45° (PR-2B) ³⁾	574524
	M 22 45° (PR-2B) ³⁾	574526
	M 28 45° (PR-2B) ³⁾	574528
	M 35 45° (PR-2B) ³⁾	574530
COMAP	M 12	578310
Xpress Copper	M 15	578312
	M 18 ¹⁾	578314
	M 22	578316
	M 28 ¹⁾	578318
	M 35	578390
	M 12 45° (PR-2B) ³⁾	574520
	M 15 45° (PR-2B) ³⁾	574522
	M 18 45° (PR-2B) ³⁾	574524
	M 22 45° (PR-2B) ³⁾	574526
	M 28 45° (PR-2B) ³⁾	574528
	M 35 45° (PR-2B) ³⁾	574530
COMAP	M 15	578312
Xpress Copper	M 18 ¹⁾	578314
Gas	M 22	578316
	M 28 ¹⁾	578318
	M 35	578390

System	Pressing contour	Art.-No.
COMAP	M 15	578312
Xpress Stainless	M 18 ¹⁾	578314
	M 22	578316
	M 28 ¹⁾	578318
	M 35	578390
	M 15 45° (PR-2B) ³⁾	574522
	M 18 45° (PR-2B) ³⁾	574524
	M 22 45° (PR-2B) ³⁾	574526
	M 28 45° (PR-2B) ³⁾	574528
	M 35 45° (PR-2B) ³⁾	574530
COMISA	TH 14	578348
Press System	TH 16	578352
	TH 18	578356
	TH 20	578358
	TH 25	578360
	TH 26	578362
	TH 32	578364
	TH 40	578624
	H 14	578398
	H 16	578400
	H 18	578404
	H 20	578406
	H 26	578410
	H 32	578412
	B 14	578466
	B 16	578468
	B 18	578470
	B 20	578472
	B 26	578474
	B 32	578476
COMISA	TH 16	578352
Press System Gas	TH 20	578358
	TH 26	578362
	TH 32	578364
CONEL	F 16	578456
CONNECT	F 20	578460
MULTI	F 26	578462
	F 32	578464
	H 16	578400
	H 20	578406
	H 26	578410
	H 32	578412
	TH 16	578352
	TH 20	578358
	TH 26	578362
	TH 32	578364
	U 16	578374
	U 20	578378
(DN 26)	U 25	578380
	U 32	578382
	VP 16	578482
	VP 20	578484
	VP 32	578488
DIWAsystems	TH 14	578348
	TH 16	578352
	TH 20	578358
	TH 26	578362
	TH 32	578364
	TH 40	578624
DUOFIL	U 16	578374
MKSYSTEM	U 18	578376
	U 20	578378
	U 25	578380
	U 32	578382
DW Verbundrohr	U 16	578374
multitubo systems	U 18	578376
	U 20	578378
	U 25	578380
	U 32	578382
EBRILLE	U 16	578374
Isomonflex	U 18	578376
	U 20	578378
	U 25	578380
	H 26	578410
	TH 26	578362
	U 32	578382
EBRILLE	U 14	578372
Monflex	U 16	578374
	U 18	578376
	U 20	578378
	U 25	578380
	H 26	578410
	TH 26	578362
	U 32	578382
	U 40	578386
EFFEBI	M 15	578312
PRESSTIGE	M 18	578314
	M 22	578316
	M 28	578318
	M 35	578390
	M 15 45° (PR-2B) ³⁾	574522
	M 18 45° (PR-2B) ³⁾	574524
	M 22 45° (PR-2B) ³⁾	574526
	M 28 45° (PR-2B) ³⁾	574528
	M 35 45° (PR-2B) ³⁾	574530
	V 15	578328
	V 18	578332
	V 22	578334
	V 28	578336
	V 35	578604
	V 15 45° (PR-2B) ³⁾	574504
	V 18 45° (PR-2B) ³⁾	574506
	V 22 45° (PR-2B) ³⁾	574508
	V 28 45° (PR-2B) ³⁾	574510
	V 35 45° (PR-2B) ³⁾	574512

System	Pressing contour	Art.-No.
EFFEBI TOF	TH 16	578352
MULTIPINZA	TH 18	578356
	TH 20	578358
	TH 26	578362
	TH 32	578364
	TH 40	578624
	F 16	578456
	F 18	578458
	F 20	578460
	F 26	578462
	F 32	578464
	H 16	578400
	H 18	578404
	H 20	578406
	H 26	578410
	H 32	578412
	U 16	578374
	U 18	578376
	U 20	578378
	U 25	578380
	C 26	578392
	U 32	578382
	U 40	578386
	B 16	578468
	B 18	578470
	B 20	578472
	B 26	578474
	B 32	578476
Elkhart	VUS 1/2" (OD 15,9 mm)	578566
APOLLOXPRESS	VUS 3/4" (OD 22,2 mm)	578568
Fittings Copper	VUS 1" (OD 26,6 mm)	578570
and Low-Lead Brass	VUS 1 1/4" (OD 34,9 mm)	578606
EMMETI	B 16	578468
GERPEX-	B 20	578472
FIVPRESS	B 26	578474
	B 32	578476
	F 16	578456
	F 20	578460
	H 16	578400
	H 20	578406
	TH 16	578352
	TH 20	578358
	TH 26	578362
	TH 32	578364
	TH 40	578624
	U 16	578374
	U 20	578378
EMPUR	TH 15	578350
	TH 17	578354
	TH 20	578358
EURACCORDI	M 15	578312
SYCPRESS	M 18	578314
STAINLESS	M 22	578316
STEEL PRESS	M 28	578318
FITTINGS	M 35	578390
	M 15 45° (PR-2B) ³⁾	574522
	M 18 45° (PR-2B) ³⁾	574524
	M 22 45° (PR-2B) ³⁾	574526
	M 28 45° (PR-2B) ³⁾	574528
	M 35 45° (PR-2B) ³⁾	574530
EURACCORDI	M 15	578312
SYCPRESS	M 18	578314
CARBON STEEL	M 22	578316
PRESS FITTINGS	M 28	578318
	M 35	578390
	M 15 45° (PR-2B) ³⁾	574522
	M 18 45° (PR-2B) ³⁾	574524
	M 22 45° (PR-2B) ³⁾	574526
	M 28 45° (PR-2B) ³⁾	574528
	M 35 45° (PR-2B) ³⁾	574530
EUROTUBI	M 12	578310
Europa C-STAH	M 15	578312
PRESSFITTING	M 18	578314
SISTEM ¹⁾	M 22	578316
	M 28	578318
	M 35	578390
	M 12 45° (PR-2B) ³⁾	574520
	M 15 45° (PR-2B) ³⁾	574522
	M 18 45° (PR-2B) ³⁾	574524
	M 22 45° (PR-2B) ³⁾	574526
	M 28 45° (PR-2B) ³⁾	574528
	M 35 45° (PR-2B) ³⁾	574530
EUROTUBI	M 15	578312
Europa INOX	M 18	578314
PRESSFITTING	M 22	578316
SISTEM ¹⁾	M 28	578318
	M 35	578390
	M 15 45° (PR-2B) ³⁾	574522
	M 18 45° (PR-2B) ³⁾	574524
	M 22 45° (PR-2B) ³⁾	574526
	M 28 45° (PR-2B) ³⁾	574528
	M 35 45° (PR-2B) ³⁾	574530
Evans	VAU 15 (1/2")	578630
Components	VAU 20 (3/4")	578632
Presslok	VAU 25 (1")	578634

System	Pressing contour	Art.-No.
FAR Rubinetterie	TH 14	578348
PRESSFAR	TH 16	578352
	TH 17	578354
	TH 18	578356
	TH 20	578358
	TH 25	578360
	TH 26	578362
	TH 32	578364
	TH 40	578624
	H 14	578398
	H 16	578400
	H 18	578404
	H 20	578406
	H 26	578410
	H 32	578412
	U 14	578372
	U 16	578374
	U 18	578376
	U 20	578378
	U 25	578380
	U 32	578382
	U 40	578386
F.B.Q. BARONIO	V 12	578324
BQ press	V 14	578326
	V 15	578328
	V 16	578330
	V 18	578332
	V 22	578334
	V 28	578336
	V 35	578604
	V 12 45° (PR-2B) ³⁾	574502
	V 14 45° (PR-2B) ³⁾	574532
	V 15 45° (PR-2B) ³⁾	574504
	V 16 45° (PR-2B) ³⁾	574534
	V 18 45° (PR-2B) ³⁾	574506
	V 22 45° (PR-2B) ³⁾	574508
	V 28 45° (PR-2B) ³⁾	574510
	V 35 45° (PR-2B) ³⁾	574512
F.B.Q. BARONIO	V 15	578328
BQ press	V 18	578332
carbon steel	V 22	578334
	V 28	578336
	V 35	578604
	V 15 45° (PR-2B) ³⁾	574504
	V 18 45° (PR-2B) ³⁾	574506
	V 22 45° (PR-2B) ³⁾	574508
	V 28 45° (PR-2B) ³⁾	574510
	V 35 45° (PR-2B) ³⁾	574512
F.B.Q. BARONIO	V 15	578328
BQ press gas	V 18	578332
	V 22	578334
	V 28	578336
	V 35	578604
	V 15 45° (PR-2B) ³⁾	574504
	V 18 45° (PR-2B) ³⁾	574506
	V 22 45° (PR-2B) ³⁾	574508
	V 28 45° (PR-2B) ³⁾	574510
	V 35 45° (PR-2B) ³⁾	574512
Fercofloor	RFz 16	578492
DUO Press	RFz 20	578494
FERCO PEX	RFz 25	578496
	RFz 32	578498
Fercofloor	RFz 16	578492
DUO Press	RFz 20	578494
MULTIFER	RFz 25	578496
	RFz 32	578498
	U 16	578374
	U 18	578376
	U 20	578378
	U 25	578380
	U 32	578382
FILTUBE	M 15	578312
Instalpress	M 18	578314
Carbon Steel	M 22	578316
	M 28	578318
	M 35	578390
	M 15 45° (PR-2B) ³⁾	574522
	M 18 45° (PR-2B) ³⁾	574524
	M 22 45° (PR-2B) ³⁾	574526
	M 28 45° (PR-2B) ³⁾	574528
	M 35 45° (PR-2B) ³⁾	574530
FILTUBE	M 15	578312
Instalpress	M 18	578314
Copper	M 22	578316
	M 28	578318
	M 35	578390
	M 15 45° (PR-2B) ³⁾	574522
	M 18 45° (PR-2B) ³⁾	574524
	M 22 45° (PR-2B) ³⁾	574526
	M 28 45° (PR-2B) ³⁾	574528
	M 35 45° (PR-2B) ³⁾	574530

System	Pressing contour	Art.-No.
FILTUBE	M 15	578312
Instalpress	M 18	578314
Inox	M 22	578316
	M 28	578318
	M 35	578390
	M 15 45° (PR-2B) ³⁾	574522
	M 18 45° (PR-2B) ³⁾	574524
	M 22 45° (PR-2B) ³⁾	574526
	M 28 45° (PR-2B) ³⁾	574528
	M 35 45° (PR-2B) ³⁾	574530
Fittings Estándar	RFz 16	578492
ECO-PRESS	RFz 20	578494
	RFz 25	578496
	RFz 32	578498
Fittings Estándar	RFz 16	578492
MULTICAPA	RFz 18	578638
	RFz 20	578494
	RFz 25	578496
	RFz 32	578498
Fittings Estándar	RFz 16	578492
PE-X	RFz 20	578494
	RFz 25	578496
	RFz 32	578498
FOHS	TH 16	578352
HEIZTECHNIK	TH 20	578358
FOHSPRESS	TH 26	578362
	TH 32	578364
FORNARA	B 16	578468
ForPress	B 20	578472
	B 26	578474
	B 32	578476
	F 16	578456
	F 20	578460
	F 26	578464
	F 32	578466
	H 16	578400
	H 20	578406
	H 26	578410
	H 32	578412
	TH 16	578352
	TH 20	578358
	TH 26	578362
	TH 32	578364
	U 16	578374
	U 20	578378
	U 32	578382
FRABO	V 12	578324
FRABOPRESS	V 15	578328
RAME (Cu)	V 18	578332
	V 22	578334
	V 28	578336
	V 35	578604
	V 12 45° (PR-2B) ³⁾	574502
	V 15 45° (PR-2B) ³⁾	574504
	V 18 45° (PR-2B) ³⁾	574506
	V 22 45° (PR-2B) ³⁾	574508
	V 28 45° (PR-2B) ³⁾	574510
	V 35 45° (PR-2B) ³⁾	574512
FRABO	V 12	578324
FRABOPRESS	V 15	578328
RAME (Cu)	V 18	578332
	V 22	578334
	V 28	578336
	V 35	578604
	V 12 45° (PR-2B) ³⁾	574502
	V 15 45° (PR-2B) ³⁾	574504
	V 18 45° (PR-2B) ³⁾	574506
	V 22 45° (PR-2B) ³⁾	574508
	V 28 45° (PR-2B) ³⁾	574510
	V 35 45° (PR-2B) ³⁾	574512
FRABO	V 12	578324
FRABOPRESS	V 15	578328
INOX 316	V 18	578332
	V 22	578334
	V 28	578336
	V 35	578604
	V 12 45° (PR-2B) ³⁾	574502
	V 15 45° (PR-2B) ³⁾	574504
	V 18 45° (PR-2B) ³⁾	574506
	V 22 45° (PR-2B) ³⁾	574508
	V 28 45° (PR-2B) ³⁾	574510
	V 35 45° (PR-2B) ³⁾	574512
FRABO	V 15	578328
FRABOPRESS	V 18	578332
C-STEEL	V 22	578334
	V 28	578336
	V 35	578604
	V 12 45° (PR-2B) ³⁾	574502
	V 15 45° (PR-2B) ³⁾	574504
	V 18 45° (PR-2B) ³⁾	574506
	V 22 45° (PR-2B) ³⁾	574508
	V 28 45° (PR-2B) ³⁾	574510
	V 35 45° (PR-2B) ³⁾	574512

System	Pressing contour	Art.-No.
FRABO	V 15	578328
FRABOPRESS	V 18	578332
C-STEEL GAS	V 22	578334
	V 28	578336
	V 35	578604
	V 15 45° (PR-2B) ³⁾	574504
	V 18 45° (PR-2B) ³⁾	574506
	V 22 45° (PR-2B) ³⁾	574508
	V 28 45° (PR-2B) ³⁾	574510
	V 35 45° (PR-2B) ³⁾	574512
FRABO	TH 16	578352
FRABOPRESS	TH 20	578358
MULTI-BRASS	TH 26	578362
(MB)	TH 32	578364
	U 16	578374
	U 20	578378
FRABO	H 16	578400
FRABOPRESS	H 20	578406
MULTI-PLUS	U 16	578374
(MP)	U 20	578378
FRABO	V 15	578328
SOLARPRESS	V 18	578332
	V 22	578334
	V 28	578336
	V 15 45° (PR-2B) ³⁾	574504
	V 18 45° (PR-2B) ³⁾	574506
	V 22 45° (PR-2B) ³⁾	574508
	V 28 45° (PR-2B) ³⁾	574510
Fränkische	B 16	578468
alpeX-duo	B 18	578470
	B 20	578472
	B 26	578474
	B 32	578476
	F 16	578456
	F 18	578458
	F 20	578460
	F 26	578464
	F 32	578466
	TH 16	578352
	TH 18	578356
	TH 20	578358
	TH 26	578362
	TH 32	578364
Fränkische	F 16	578456
alpeX F50 PROFIL	F 20	578460
	F 26	578462
	F 32	578464
	H 16	578400
	H 20	578406
	H 26	578412
	H 32	578352
	TH 16	578352
	TH 20	578358
	TH 26	578362
	TH 32	578364
	U 16	578374
	U 20	578378
(DN 26)	U 25	578380
	U 32	578382
	VP 16	578482
	VP 20	578484
	VP 32	578488
Fränkische	F 20	578460
alpeX-gas	F 26	578462
	F 32	578464
Fränkische	F 40	578478
alpeX L		
gaboTherm H+S	TH 10	578342
	TH 12	578346
	TH 14	578348
	TH 15	578350
	TH 16	578352
	TH 17	578354
	TH 18	578356
	TH 20	578358
	TH 25	578360
	TH 26	578362
	TH 32	578364
	TH 40	578624
Geberit Mapress	M 12	578310
C-STAHl	M 15	578312
	M 18	578314
	M 22	578316
	M 28	578318
	M 35	578390
	M 12 45° (PR-2B) ³⁾	574520
	M 15 45° (PR-2B) ³⁾	574522
	M 18 45° (PR-2B) ³⁾	574524
	M 22 45° (PR-2B) ³⁾	574526
	M 28 45° (PR-2B) ³⁾	574528
	M 35 45° (PR-2B) ³⁾	574530

Pressfitting systems for gas installations must only be pressed with REMS pressing tongs Mini/pressing rings which are highlighted in yellow. Observe the national regulations.

- 1) Only pressing tongs from designation "108" (1st quarter of 2008), "208" (2nd quarter of 2008) etc. can be used. The designation is stamped on every pressing jaw.
- 2) For taking suitable pressing inserts.
- 3) Adapter tongs are required for driving pressing rings (PR), see page 136.

The suitability of REMS pressing tools for pressfitting systems: Date 09.10.2015. For the updated situation regarding suitability status check our website: www.rems.de → Downloads → Product catalogues, brochures → REMS Catalogue. Pressing tongs for additional pressfitting systems on request.

REMS pressing tongs Mini
REMS pressing rings

Accessories for REMS Mini-Press ACC and
REMS Mini-Press 22 V ACC

System	Pressing contour	Art.-No.	
Geberit Mapress EDELSTAHL	M 12	578310	
	M 15	578312	
	M 18	578314	
	M 22	578316	
	M 28	578318	
	M 35	578390	
	M 12 45° (PR-2B) ⁽³⁾	574520	
	M 15 45° (PR-2B) ⁽³⁾	574522	
	M 18 45° (PR-2B) ⁽³⁾	574524	
	M 22 45° (PR-2B) ⁽³⁾	574526	
	M 28 45° (PR-2B) ⁽³⁾	574528	
	M 35 45° (PR-2B) ⁽³⁾	574530	
	Geberit Mapress EDELSTAHL Gas	M 15	578312
		M 18	578314
M 22		578316	
M 28		578318	
M 35		578390	
M 15 45° (PR-2B) ⁽³⁾		574522	
M 18 45° (PR-2B) ⁽³⁾		574524	
M 22 45° (PR-2B) ⁽³⁾		574526	
M 28 45° (PR-2B) ⁽³⁾		574528	
M 35 45° (PR-2B) ⁽³⁾		574530	
Geberit Mapress KUPFER		M 12	578310
		M 15	578312
		M 18	578314
		M 22	578316
	M 28	578318	
	M 35	578390	
	M 12 45° (PR-2B) ⁽³⁾	574520	
	M 15 45° (PR-2B) ⁽³⁾	574522	
	M 18 45° (PR-2B) ⁽³⁾	574524	
	M 22 45° (PR-2B) ⁽³⁾	574526	
	M 28 45° (PR-2B) ⁽³⁾	574528	
	M 35 45° (PR-2B) ⁽³⁾	574530	
	Geberit Mapress KUPFER Gas	M 15	578312
		M 18	578314
M 22		578316	
M 28		578318	
M 35		578390	
M 15 45° (PR-2B) ⁽³⁾		574522	
M 18 45° (PR-2B) ⁽³⁾		574524	
M 22 45° (PR-2B) ⁽³⁾		574526	
M 28 45° (PR-2B) ⁽³⁾		574528	
M 35 45° (PR-2B) ⁽³⁾		574530	
Geberit Mepla		G 16	578444
		G 20	578446
		G 26	578448
		G 32	578450
	G 40	578452	
	General Fittings Serie 5S00	TH 16	578352
TH 18		578356	
TH 20		578358	
TH 25		578360	
TH 26		578362	
TH 32		578364	
TH 40		578624	
H 16		578400	
H 18		578404	
H 20		578406	
H 25		578408	
H 26		578410	
H 32		578412	
U 16		578374	
U 18		578376	
U 20		578378	
U 32		578382	
U 40		578386	
B 16		578468	
B 18		578470	
B 20		578472	
B 26		578474	
B 32		578476	
General Fittings Trident		TH 16	578352
		TH 20	578358
		TH 26	578362
	TH 32	578364	
	H 16	578400	
	H 20	578406	
	H 26	578410	
	H 32	578412	
	U 16	578374	
	U 20	578378	
	U 32	578382	
	B 16	578468	
	B 20	578472	
	B 26	578474	
B 32	578476		
General Fittings Trident Gas	TH 16	578352	
	TH 20	578358	
	TH 26	578362	
	TH 32	578364	
	H 16	578400	
	H 20	578406	
	H 26	578410	
	H 32	578412	
	U 16	578374	
	U 20	578378	
	U 32	578382	
	Giacomini Raccordi RM Giacomini	H 16	578400
		H 20	578406
		H 26	578410
H 32		578412	
TH 16		578352	
TH 20		578358	
TH 26	578362		
TH 32	578364		
THL 32	578368		
U 16	578374		
U 20	578378		
U 32	578382		
U 40	578386		

System	Pressing contour	Art.-No.	
Giacomini RM MULTIGAS	H 16	578400	
	H 20	578406	
	H 26	578410	
	H 32	578412	
	TH 16	578352	
	TH 20	578358	
	TH 26	578362	
	TH 32	578364	
	THL 32	578368	
	U 16	578374	
	U 20	578378	
	U 32	578382	
	Giacomini Valvole Giacomini serie R850V	V 15	578328
		V 18	578332
V 22		578334	
V 28		578336	
V 35		578604	
V 15 45° (PR-2B) ⁽³⁾		574504	
V 18 45° (PR-2B) ⁽³⁾		574506	
V 22 45° (PR-2B) ⁽³⁾		574508	
V 28 45° (PR-2B) ⁽³⁾		574510	
V 35 45° (PR-2B) ⁽³⁾		574512	
SA 15		578514	
SA 18		578518	
SA 22		578520	
SA 28		578522	
Golan Pipe Systems (Scandinavia) Alu-Pres	U 16	578374	
	U 20	578378	
	U 25	578380	
	U 32	578382	
	U 40	578386	
	Grinnell G-PRESS Copper Fittings	VUS ½" (OD 15,9 mm)	578566
		VUS ¾" (OD 22,2 mm)	578568
		VUS 1" (OD 28,6 mm)	578570
		VUS 1½" (OD 34,9 mm)	578606
		GS	
	GS Wärmesysteme System TH	TH 14	578348
		TH 16	578352
		TH 20	578358
		TH 26	578362
TH 32		578364	
TH 40	578624		
GS Wärmesysteme System V	V 15	578328	
	V 18	578332	
	V 22	578334	
	V 28	578336	
	V 35	578604	
	V 15 45° (PR-2B) ⁽³⁾	574504	
	V 18 45° (PR-2B) ⁽³⁾	574506	
	V 22 45° (PR-2B) ⁽³⁾	574508	
	V 28 45° (PR-2B) ⁽³⁾	574510	
	V 35 45° (PR-2B) ⁽³⁾	574512	
	GSP Group USMetrix	U 16	578374
U 20		578378	
HAGOS		TH 16	578352
HakaGerodur		TH 10	578342
HakaGerodur-		TH 11,6	578344
System		TH 12	578346
HakaGerodur HAKASAN	TH 14	578348	
	TH 16	578352	
	TH 17	578354	
	TH 18	578356	
	TH 20	578358	
	TH 16	578352	
	TH 20	578358	
	TH 25	578360	
	TH 26	578362	
	TH 32	578364	
	TH 40	578624	
Harden 2000 B-Hidro	TH 16	578352	
	TH 20	578358	
	TH 26	578362	
Harden 2000 Poly-Pex 2000	TH 14	578348	
	TH 16	578352	
	TH 17	578354	
	TH 18	578356	
	TH 20	578358	
	TH 26	578362	
	THL 32	578368	
	TH 40	578624	
	Harden 2000 Poly-Pex Gas	TH 16	578352
		TH 20	578358
		TH 26	578362
THL 32		578368	
HASTINIK Hastinik/Hitpress	M 15	578312	
	M 18	578314	
	M 22	578316	
	M 28	578318	
	M 35	578390	
	M 15 45° (PR-2B) ⁽³⁾	574522	
	M 18 45° (PR-2B) ⁽³⁾	574524	
	M 22 45° (PR-2B) ⁽³⁾	574526	
	M 28 45° (PR-2B) ⁽³⁾	574528	
M 35 45° (PR-2B) ⁽³⁾	574530		
heima-press	TH 16	578352	
	TH 20	578358	
	TH 26	578362	
	TH 32	578364	
TH 40	578624		
HELIROMA klimapress	U 16	578374	
	U 18	578376	
	U 20	578378	
	U 25	578380	
	U 32	578382	
	U 40	578386	
	HELIROMA romapress	RFz 16	578492
RFz 20		578494	
RFz 25		578496	
RFz 32		578498	

System	Pressing contour	Art.-No.	
Henco	TH 14	578348	
	TH 16	578352	
	TH 18	578356	
	TH 20	578358	
	TH 26	578362	
Henco Gas	TH 16	578352	
	TH 20	578358	
	TH 26	578362	
Herotec TEMPUS-PRESS PLUS	H 16	578400	
	H 20	578406	
	H 25	578408	
	H 32	578412	
	TH 16	578352	
	TH 20	578358	
	TH 25	578360	
	TH 32	578364	
	U 16	578374	
	U 20	578378	
	U 25	578380	
U 32	578382		
U 40	578386		
Herz pipefix	TH 10	578342	
	TH 16	578352	
	TH 20	578358	
	TH 26	578362	
	TH 32	578364	
	TH 40	578624	
HITEC Sistema Multistrato	TH 14	578348	
	TH 16	578352	
	TH 18	578356	
	TH 20	578358	
Hopewell press fit system	TH 26	578362	
	TH 32	578364	
	TH 40	578624	
	M 15	578312	
	M 18	578314	
	M 22	578316	
hp-praski BAVARIA-press	M 28	578318	
	M 35	578390	
	TH 10	578342	
	TH 14	578346	
	TH 16	578352	
IBP >B< Flex	TH 20	578358	
	TH 26	578362	
	TH 32	578364	
	TH 40	578624	
	U 16	578374	
	U 18	578376	
	U 20	578378	
	U 25	578380	
	U 32	578382	
	IBP >B< Press	V 12	578324
		V 14	578326
		V 15	578328
		V 16	578330
		V 18	578332
V 22		578334	
V 28		578336	
V 35		578604	
V 12 45° (PR-2B) ⁽³⁾		574502	
V 14 45° (PR-2B) ⁽³⁾		574504	
V 15 45° (PR-2B) ⁽³⁾		574506	
V 16 45° (PR-2B) ⁽³⁾		574508	
V 18 45° (PR-2B) ⁽³⁾		574510	
V 28 45° (PR-2B) ⁽³⁾		574512	
IBP >B< Press Carbon	V 12	578324	
	V 15	578328	
	V 18	578332	
	V 22	578334	
	V 28	578336	
	V 35	578604	
	V 12 45° (PR-2B) ⁽³⁾	574502	
	V 15 45° (PR-2B) ⁽³⁾	574504	
	V 18 45° (PR-2B) ⁽³⁾	574506	
	V 22 45° (PR-2B) ⁽³⁾	574508	
	V 28 45° (PR-2B) ⁽³⁾	574510	
V 35 45° (PR-2B) ⁽³⁾	574512		
IBP >B< Press Gas	V 15	578328	
	V 18	578332	
	V 22	578334	
	V 28	578336	
	V 35	578604	
	V 15 45° (PR-2B) ⁽³⁾	574504	
IBP >B< Press Inox	V 18 45° (PR-2B) ⁽³⁾	574506	
	V 22 45° (PR-2B) ⁽³⁾	574508	
	V 28 45° (PR-2B) ⁽³⁾	574510	
	V 35 45° (PR-2B) ⁽³⁾	574512	
	V 15	578328	
	V 18	578332	
	V 22	578334	
	V 28	578336	
	V 35	578604	
	V 15 45° (PR-2B) ⁽³⁾	574504	
	V 18 45° (PR-2B) ⁽³⁾	574506	
	V 22 45° (PR-2B) ⁽³⁾	574508	
	V 28 45° (PR-2B) ⁽³⁾	574510	
	V 35 45° (PR-2B) ⁽³⁾	574512	
IBP >B< Press Solar	V 15	578328	
	V 18	578332	
	V 22	578334	
	V 28	578336	
	V 35	578604	
	V 15 45° (PR-2B) ⁽³⁾	574504	
	V 18 45° (PR-2B) ⁽³⁾	574506	
Idrosanitaria Bonomi Homegas	TH 16	578352	
	TH 20	578358	
	TH 26	578362	

System	Pressing contour	Art.-No.	
Idrosanitaria Bonomi Idropress	TH 16	578352	
	TH 18	578356	
	TH 20	578358	
	TH 26	578362	
	TH 32	578364	
TH 40	578624		
IDROSISTEMI Ta-Press	TH 16	578352	
	TH 20	578358	
	TH 26	578362	
	TH 32	578364	
	TH 40	578624	
	F 16	578456	
	F 20	578460	
	F 26	578462	
	F 32	578464	
	F 40	578478	
	H 16	578400	
	H 20	578406	
	H 26	578410	
	H 32	578412	
	U 16	578374	
	U 20	578378	
	C 26	578392	
	U 32	578382	
	U 40	578386	
	B 16	578468	
	B 20	578472	
	B 26	578474	
	B 32	578476	
IPA IPANA Press	TH 10	578342	
	TH 11,6	578344	
	TH 12	578346	
	TH 14	578348	
	TH 15	578350	
	TH 16	578352	
	TH 17	578354	
	TH 18	578356	
	TH 20	578358	
	TH 22	578588	
	TH 25	578360	
	TH 26	578362	
	TH 28	578590	
	TH 32	578364	
	TH 40	578624	
	IPA THu IPANA Press	TH 16	578352
		TH 20	578358
		TH 26	578362
		TH 32	578364
		TH 40	578624
U 16		578374	
U 20		578378	
H 16		578400	
H 20		578406	
H 26		578410	
H 32	578412		
IPALPEX (Industrie du Plastique et Accessoires)	TH 14	578348	
	TH 16	578352	
	TH 18	578356	
	TH 20	578358	
	TH 26	578362	
THL 32	578368		
TH 40	578624		
IPLEX PIPELINES AUSTRALIA Iplex Pro-fit	K16/P18	578592	
	IPLEX PIPELINES AUSTRALIA Iplex K1 (Gas)	K16/P18	578592
		K/20	578594
		K/25	578596
		K32	578598
		K1/40	578600
IPLEX PIPELINES AUSTRALIA Iplex K2	K16/P18	578592	
	K/20	578594	
	K/25	578596	
ISOTUBI NUMEPRESS	M 15	578312	
	M 18	578314	
	M 22	578316	
	M 28	578318	
	M 35	578390	
	M 15 45° (PR-2B) ³⁾	574522	
	M 18 45° (PR-2B) ³⁾	574524	
	M 22 45° (PR-2B) ³⁾	574526	
M 28 45° (PR-2B) ³⁾	574528		
M 35 45° (PR-2B) ³⁾	574530		
IVAR ALPEX-GAS	B 20	578472	
	B 26	578474	
	B 32	578476	
IVAR Ivar-Press	B 14	578466	
	B 16	578468	
	B 18	578470	
	B 20	578472	
	B 26	578474	
	B 32	578476	
	F 40	578478	
	IVAR MULTI PRESS GAS	TH 16	578352
TH 20		578358	
TH 26		578362	
TH 32		578364	
B 16		578468	
B 20		578472	
B 26		578474	
B 32		578476	

System	Pressing contour	Art.-No.	
IVAR MULTI PRESS GAS ITALIA	TH 16	578352	
	TH 20	578358	
	TH 26	578362	
	H 16	578400	
	H 20	578406	
	H 26	578410	
	IVAR Multi Press MP	TH 16	578352
		TH 18	578356
		TH 20	578358
		TH 25	578360
		TH 26	578362
		TH 32	578364
TH 40		578624	
F 16		578456	
F 18		578458	
F 20		578460	
F 26		578462	
F 32		578464	
F 40		578478	
H 16		578400	
H 18		578404	
H 20		578406	
H 25		578408	
H 26		578410	
H 32		578412	
U 16	578374		
U 18	578376		
U 20	578378		
U 25	578380		
C 26	578392		
U 32	578382		
U 40	578386		
B 16	578468		
B 18	578470		
B 20	578472		
B 26	578474		
B 32	578476		
IVAR Multi Press Leak (MPL)	TH 16	578352	
	TH 20	578358	
	TH 26	578362	
	TH 32	578364	
	F 16	578456	
	F 20	578460	
	F 26	578462	
	F 32	578464	
	H 16	578400	
	H 20	578406	
	H 26	578410	
H 32	578412		
U 16	578374		
U 20	578378		
C 26	578392		
U 32	578382		
B 16	578468		
B 20	578472		
B 26	578474		
B 32	578476		
IVAR Plastic Multi Press PMP	TH 16	578352	
	TH 20	578358	
	TH 25	578360	
	TH 26	578362	
	TH 32	578364	
	F 16	578456	
	F 20	578460	
	F 26	578462	
	F 32	578464	
	H 16	578400	
H 20	578406		
H 26	578410		
H 32	578412		
U 16	578374		
U 20	578378		
U 25	578380		
C 26	578392		
U 32	578382		
B 16	578468		
B 20	578472		
B 26	578474		
B 32	578476		
IVAR Plastic Multi Press Leak (PMPL)	TH 16	578352	
	TH 20	578358	
	TH 26	578362	
	TH 32	578364	
	F 16	578456	
	F 20	578460	
	F 26	578462	
	F 32	578464	
	H 16	578400	
	H 20	578406	
	H 26	578410	
	H 32	578412	
U 16	578374		
U 20	578378		
C 26	578392		
U 32	578382		
B 16	578468		
B 20	578472		
B 26	578474		
B 32	578476		

System	Pressing contour	Art.-No.	
Jäger - Aquatec Aquapress H	H 14	578398	
	H 16	578400	
	H 17	578402	
	H 18	578404	
	H 20	578406	
	H 26	578410	
	H 32	578412	
	U 40	578386	
	Jäger - Aquatec C-Stahl - Press Typ M	M 15	578312
		M 18	578314
		M 22	578316
M 28		578318	
M 35		578390	
M 15 45° (PR-2B) ³⁾		574522	
M 18 45° (PR-2B) ³⁾		574524	
M 22 45° (PR-2B) ³⁾	574526		
M 28 45° (PR-2B) ³⁾	574528		
M 35 45° (PR-2B) ³⁾	574530		
Jäger - Aquatec Edelstahl - Press Typ M	M 15	578312	
	M 18	578314	
	M 22	578316	
	M 28	578318	
	M 35	578390	
Jäger - Aquatec Kuiper - Press Typ V	V 15	578328	
	V 18	578332	
	V 22	578334	
	V 28	578336	
	V 35	578604	
	V 15 45° (PR-2B) ³⁾	574504	
	V 18 45° (PR-2B) ³⁾	574506	
V 22 45° (PR-2B) ³⁾	574508		
V 28 45° (PR-2B) ³⁾	574510		
V 35 45° (PR-2B) ³⁾	574512		
Jansen JANSEN prima	TH 14	578348	
	TH 16	578352	
	TH 18	578356	
	TH 20	578358	
	TH 25	578360	
TH 26	578362		
TH 32	578364		
TH 40	578624		
Jaraflex- Presssystem	TH 14	578348	
	TH 16	578352	
	TH 20	578358	
	TH 25	578360	
	TH 26	578362	
	TH 32	578364	
TH 40	578624		
KAN KAN-therm	U 16	578374	
	U 20	578378	
	U 25	578380	
	C 26	578392	
KAN KAN-therm LBP	U 32	578382	
	U 40	578386	
	TH 14	578348	
	TH 16	578352	
	TH 20	578358	
	TH 25	578360	
	TH 26	578362	
	TH 32	578364	
	TH 40	578624	
	U 14	578372	
U 16	578374		
U 20	578378		
U 25	578380		
C 26	578392		
U 32	578382		
U 40	578386		
KAN KAN-therm Inox	M 15	578312	
	M 18 ¹⁾	578314	
	M 22	578316	
	M 28 ¹⁾	578318	
KAN KAN-therm Steel	M 35	578390	
	M 15 45° (PR-2B) ³⁾	574522	
	M 18 45° (PR-2B) ³⁾	574524	
	M 22 45° (PR-2B) ³⁾	574526	
	M 28 45° (PR-2B) ³⁾	574528	
	M 35 45° (PR-2B) ³⁾	574530	
	M 15	578312	
	M 18 ¹⁾	578314	
	M 22	578316	
	M 28 ¹⁾	578318	
	M 35	578390	
M 15 45° (PR-2B) ³⁾	574522		
M 18 45° (PR-2B) ³⁾	574524		
M 22 45° (PR-2B) ³⁾	574526		
M 28 45° (PR-2B) ³⁾	574528		
M 35 45° (PR-2B) ³⁾	574530		
KE KELIT KELIT KELOX	U 16	578374	
	U 18	578376	
	U 20	578378	
	U 25	578380	
	U 32	578382	
	U 40	578386	

Pressfitting systems for gas installations must only be pressed with REMS pressing tongs Mini/pressing rings which are highlighted in yellow. Observe the national regulations.

- 1) Only pressing tongs from designation "108" (1st quarter of 2008), "208" (2nd quarter of 2008) etc. can be used. The designation is stamped on every pressing jaw.
- 2) For taking suitable pressing inserts.
- 3) Adapter tongs are required for driving pressing rings (PR), see page 136.

The suitability of REMS pressing tools for pressfitting systems: Date 09.10.2015. For the updated situation regarding suitability status check our website: www.rems.de → Downloads → Product catalogues, brochures → REMS Catalogue. Pressing tongs for additional pressfitting systems on request.

System	Pressing contour	Art.-No.
KE KELIT	M 15	578312
steelFIX	M 18	578314
C-Stahl	M 22	578316
	M 28	578318
	M 35	578390
	M 15 45° (PR-2B) ³⁾	574522
	M 18 45° (PR-2B) ³⁾	574524
	M 22 45° (PR-2B) ³⁾	574526
	M 28 45° (PR-2B) ³⁾	574528
	M 35 45° (PR-2B) ³⁾	574530
KE KELIT	M 15	578312
steelFIX	M 18	578314
Edelstahl	M 22	578316
	M 28	578318
	M 35	578390
	M 15 45° (PR-2B) ³⁾	574522
	M 18 45° (PR-2B) ³⁾	574524
	M 22 45° (PR-2B) ³⁾	574526
	M 28 45° (PR-2B) ³⁾	574528
	M 35 45° (PR-2B) ³⁾	574530
KEMBLA	VAU 15 (OD 12,7 mm)	578630
KemPress	VAU 20 (OD 19,1 mm)	578632
(AUS)	VAU 25 (OD 25,4 mm)	578634
	VAU 32 (OD 31,8 mm)	578636
KEMBLA	VAU 15 (OD 12,7 mm)	578630
KemPress Gas	VAU 20 (OD 19,1 mm)	578632
(AUS)	VAU 25 (OD 25,4 mm)	578634
	VAU 32 (OD 31,8 mm)	578636
KISAN	KI 16	578524
Kisan KD	KI 20	578526
	KI 25	578528
	TH 16	578352
	TH 20	578358
	TH 25	578360
KISAN	KI 16	578524
Kisan WL	KI 20	578526
	KI 25	578528
	KI 32	578530
	TH 16	578352
	TH 20	578358
	TH 25	578360
	TH 32	578364
KISAN	KI 16	578524
Kisan WM	KI 20	578526
	KI 25	578528
	KI 32	578530
KISAN	U 20	578378
Kisan WR	U 25	578380
	U 32	578382
	U 40	578386
KISAN	M 15	578312
Kistal C	M 18	578314
	M 22	578316
	M 28	578318
	M 35	578390
	M 15 45° (PR-2B) ³⁾	574522
	M 18 45° (PR-2B) ³⁾	574524
	M 22 45° (PR-2B) ³⁾	574526
	M 28 45° (PR-2B) ³⁾	574528
	M 35 45° (PR-2B) ³⁾	574530
KISAN	M 15	578312
Kistal Inox	M 18	578314
	M 22	578316
	M 28	578318
	M 35	578390
	M 15 45° (PR-2B) ³⁾	574522
	M 18 45° (PR-2B) ³⁾	574524
	M 22 45° (PR-2B) ³⁾	574526
	M 28 45° (PR-2B) ³⁾	574528
	M 35 45° (PR-2B) ³⁾	574530
KME	TH 14	578348
cuprotherm CTX	TH 16	578352
	TH 18	578356
	TH 20	578358
	TH 26	578362
KME	TH 14	578348
QTEC - Comap	TH 16	578352
SkinPress	TH 20	578358
	TH 26	578362
KME	H 16 A	578420
QTEC - Oventrop	H 20 A	578426
Cofit	H 26 A	578430
LECHAR	TH 16	578352
ALCOBRAPEX	TH 20	578358
	TH 26	578362
	TH 32	578364
	TH 40	578624
LECHAR	U 16	578374
COBRAPEX	U 20	578378
	U 25	578380
	U 32	578382
LEGEND-PRESS	VUS ½" (OD 15,9 mm)	578566
press fitting	VUS ¾" (OD 22,2 mm)	578568
system	VUS 1" (OD 28,6 mm)	578570
	VUS 1¼" (OD 34,9 mm)	578606
LK Systems	V 12	578324
LK >B<Press	V 15	578328
	V 18	578332
	V 22	578334
	V 28	578336
	V 35	578604
	V 12 45° (PR-2B) ³⁾	574502
	V 15 45° (PR-2B) ³⁾	574504
	V 18 45° (PR-2B) ³⁾	574506
	V 22 45° (PR-2B) ³⁾	574508
	V 28 45° (PR-2B) ³⁾	574510
	V 35 45° (PR-2B) ³⁾	574512

System	Pressing contour	Art.-No.
LK Systems	V 12	578324
LK >B<Press	V 15	578328
Elförszinkat	V 18	578332
	V 22	578334
	V 28	578336
	V 35	578604
	V 12 45° (PR-2B) ³⁾	574502
	V 15 45° (PR-2B) ³⁾	574504
	V 18 45° (PR-2B) ³⁾	574506
	V 22 45° (PR-2B) ³⁾	574508
	V 28 45° (PR-2B) ³⁾	574510
	V 35 45° (PR-2B) ³⁾	574512
LK Systems	V 15	578328
LK >B<Press	V 18	578332
Gas	V 22	578334
	V 28	578336
	V 35	578604
	V 15 45° (PR-2B) ³⁾	574504
	V 18 45° (PR-2B) ³⁾	574506
	V 22 45° (PR-2B) ³⁾	574508
	V 28 45° (PR-2B) ³⁾	574510
	V 35 45° (PR-2B) ³⁾	574512
LK Systems	TH 16	578352
LK Universal	TH 20	578358
	TH 25	578360
	TH 32	578364
	TH 40	578624
LVI-DAHL	U 16	578374
Altech-Alupex	U 20	578378
	U 25	578380
	U 32	578382
MAINCOR	U 16	578374
MAINPRESS	U 20	578378
	U 25	578380
	U 32	578382
MAINCOR	U 16	578374
MAINFLOOR	U 20	578378
MAINCOR	M 15	578312
MAINOX	M 18	578314
	M 22	578316
	M 28	578318
Mair Heiztechnik	M 12	578310
Gomafix Cu/E ¹⁾	M 15	578312
	M 18	578314
	M 22	578316
	M 12 45° (PR-2B) ³⁾	574502
	M 15 45° (PR-2B) ³⁾	574504
	M 18 45° (PR-2B) ³⁾	574506
	M 22 45° (PR-2B) ³⁾	574508
Mair Heiztechnik	H 11,5	578394
Gomafix M	H 14	578398
	H 16	578400
	H 20	578406
Mair Heiztechnik	H 11,5	578394
M-Press	H 14	578398
	H 16	578400
	H 20	578406
	H 26	578410
	H 32	578412
Ma.s.ter System	TH 14	578348
PRESSMASTER	TH 16	578352
	TH 18	578356
	TH 20	578358
	TH 25	578360
	TH 26	578362
	TH 32	578364
	TH 40	578624
	H 14	578398
	H 16	578400
	H 18	578404
	H 20	578406
	H 26	578410
	H 32	578412
	U 14	578372
	U 16	578374
	U 18	578376
	U 20	578378
	U 25	578380
	U 32	578382
	U 40	578386
MEGAR0	H 11,5	578394
HAKAPRESS	H 14	578398
	H 16	578400
	H 17	578402
	H 18	578404
	H 20	578406
	H 26	578410
	H 32	578412
MEGAR0	B 16	578468
MEGAPRESS	B 20	578472
	B 26	578474
	B 32	578476
	F 40	578478
MEGAR0	TH 16	578352
MEGAPRESS MP	TH 20	578358
	TH 26	578362
	TH 32	578364
	F 16	578456
	F 20	578460
	F 26	578462
	F 32	578464
	F 40	578478
	H 16	578400
	H 20	578406
	H 26	578410
	H 32	578412
	U 16	578374
	U 20	578378
	U 32	578382
	B 16	578468
	B 20	578472
	B 26	578474
	B 32	578476

System	Pressing contour	Art.-No.
MEGAR0	TH 16	578352
MEGAPRESS	TH 20	578358
MPL	TH 26	578362
	TH 32	578364
	F 16	578456
	F 20	578460
	F 26	578462
	F 32	578464
	F 40	578478
	H 16	578400
	H 20	578406
	H 26	578410
	H 32	578412
	U 16	578374
	U 20	578378
	U 32	578382
	B 16	578468
	B 20	578472
	B 26	578474
	B 32	578476
METALGRUP	RFz 16	578492
PexGrup	RFz 20	578494
	RFz 25	578496
	RFz 32	578498
METALGRUP	U 16	578374
MultiGrup	U 18	578376
	U 20	578378
	U 25	578380
	U 32	578382
MULTITHERM	TH 16	578352
PRESSSYSTEM	TH 20	578358
	TH 26	578362
	TH 32	578364
	TH 40	578624
Multicapas	RFz 16	578492
Industrial	RFz 20	578494
AIS PEX	RFz 25	578496
	RFz 32	578498
	U 16	578374
	U 20	578378
	U 25	578380
	U 32	578382
Multicapas	MT 20	578560
Industrial	MT 25	578562
multitubo systems	MT 32	578564
MC	U 16	578374
	U 18	578376
	U 20	578378
	U 25	578380
	U 32	578382
	U 40	578386
Multicapas	H 16	578400
Industrial	H 20	578406
multitubo systems	H 25	578408
MM	H 26	578410
	H 32	578412
	MT 20	578560
	MT 25	578562
	MT 32	578564
	RFz 16	578492
	RFz 20	578494
	RFz 25	578496
	RFz 32	578498
	TH 16	578352
	TH 20	578358
	TH 25	578360
	TH 26	578362
	TH 32	578364
	U 16	578374
	U 20	578378
	U 25	578380
	U 32	578382
Multi-Flex ACR	H 12 (¾")	578396
	U 14 (¾")	578372
	U 16 (¾")	578374
	U 18 (¾")	578376
	U 20 (¾")	578378
	U 25 (¾")	578380
	U 32 (1¼")	578382
Multi-Flex Gas	U 16 (¾")	578374
	U 20 (¾")	578378
	U 25 (¾")	578380
	U 32 (1")	578382
	U 40 (1¼")	578386
Multi-Flex Water	U 16 (¾")	578374
	U 25 (¾")	578380
	U 32 (1")	578382
	U 40 (1¼")	578386
NEUTHERM	H 16	578400
MEKUPRESS-HT	H 20	578406
	H 26	578410
	H 32	578412
NIBCO (USA)	VUS ½" (OD 15,9 mm)	578566
Press System	VUS ¾" (OD 22,2 mm)	578568
Copper	VUS 1" (OD 28,6 mm)	578570
	VUS 1¼" (OD 34,9 mm)	578606
Nicoll Fluxo	TH 16	578352
	TH 20	578358
	TH 26	578362
	TH 32	578364
	TH 40	578624
NUPIGECO	U 14	578372
Multiinupi	U 16	578374
	U 18	578376
	U 20	578378
	C 26	578392
	U 32	578382
	U 40	578386

REMS pressing tongs Mini REMS pressing rings

Accessories for REMS Mini-Press ACC and REMS Mini-Press 22 V ACC

System	Pressing contour	Art.-No.
NUPIGECCO Multipinze	B 16	578468
	B 18	578470
	B 20	578472
	B 26	578474
	B 32	578476
	F 16	578456
	F 18	578458
	F 20	578460
	F 26	578462
	F 32	578464
	H 16	578400
	H 18	578404
	H 20	578406
	H 26	578410
	H 32	578412
	TH 16	578352
	TH 18	578356
	TH 20	578358
	TH 26	578362
	TH 32	578364
	U 16	578374
	U 18	578376
	U 20	578378
	C 26	578392
U 32	578382	
Nussbaum Optiflex Press	VP 16	578482
	VP 20	578484
	VP 25	578486
	VP 32	578488
Nussbaum Optipress Aquaplus	V 15	578328
	V 18	578332
	V 22	578334
	V 28	578336
	V 35	578604
	V 15 45° (PR-2B) ³⁾	574504
	V 18 45° (PR-2B) ³⁾	574506
	V 22 45° (PR-2B) ³⁾	574508
	V 28 45° (PR-2B) ³⁾	574510
	V 35 45° (PR-2B) ³⁾	574512
Nussbaum Optipress Gaz	V 15	578328
	V 18	578332
	V 22	578334
	V 28	578336
	V 35	578604
	V 15 45° (PR-2B) ³⁾	574504
	V 18 45° (PR-2B) ³⁾	574506
	V 22 45° (PR-2B) ³⁾	574508
	V 28 45° (PR-2B) ³⁾	574510
	V 35 45° (PR-2B) ³⁾	574512
Nussbaum Optipress-Therm	V 15	578328
	V 18	578332
	V 22	578334
	V 28	578336
	V 35	578604
	V 15 45° (PR-2B) ³⁾	574504
	V 18 45° (PR-2B) ³⁾	574506
	V 22 45° (PR-2B) ³⁾	574508
	V 28 45° (PR-2B) ³⁾	574510
	V 35 45° (PR-2B) ³⁾	574512
O.M.T. - Press	TH 16	578352
	TH 20	578358
	TH 26	578362
	TH 32	578364
	TH 40	578624
	Oventrop Cofit P	H 16 A
H 20 A		578426
H 26 A		578430
H 32 A		578432
PBTub SERTIPRESS	RFz 12	578490
	RFz 20	578494
PBTub SERTI-STEEL ¹⁾	M 15	578312
	M 18	578314
	M 22	578316
	M 28	578318
	M 15 45° (PR-2B) ³⁾	574522
	M 18 45° (PR-2B) ³⁾	574524
	M 22 45° (PR-2B) ³⁾	574526
	M 28 45° (PR-2B) ³⁾	574528
Pegler Yorkshire Henco Multilayer Solutions	TH 14	578348
	TH 16	578352
	TH 18	578356
	TH 20	578358
	TH 26	578362
	Pegler Yorkshire XPress Carbon	M 12
M 15		578312
M 18 ¹⁾		578314
M 22		578316
M 28 ¹⁾		578318
M 35		578390
M 12 45° (PR-2B) ³⁾		574520
M 15 45° (PR-2B) ³⁾		574522
M 18 45° (PR-2B) ³⁾		574524
M 22 45° (PR-2B) ³⁾		574526
M 28 45° (PR-2B) ³⁾		574528
M 35 45° (PR-2B) ³⁾		574530

System	Pressing contour	Art.-No.	
Pegler Yorkshire XPress Copper	M 12	578310	
	M 15	578312	
	M 18 ¹⁾	578314	
	M 22	578316	
	M 28 ¹⁾	578318	
	M 35	578390	
	M 12 45° (PR-2B) ³⁾	574520	
	M 15 45° (PR-2B) ³⁾	574522	
	M 18 45° (PR-2B) ³⁾	574524	
	M 22 45° (PR-2B) ³⁾	574526	
	M 28 45° (PR-2B) ³⁾	574528	
	M 35 45° (PR-2B) ³⁾	574530	
	Pegler Yorkshire XPress Copper Gas	M 15	578312
		M 18 ¹⁾	578314
		M 22	578316
		M 28 ¹⁾	578318
	Pegler Yorkshire XPress Solar	M 15	578312
		M 18 ¹⁾	578314
		M 22	578316
		M 28 ¹⁾	578318
		M 35	578390
		M 15 45° (PR-2B) ³⁾	574522
		M 18 45° (PR-2B) ³⁾	574524
		M 22 45° (PR-2B) ³⁾	574526
Pegler Yorkshire XPress Stainless	M 15	578312	
	M 18 ¹⁾	578314	
	M 22	578316	
	M 28 ¹⁾	578318	
	M 35	578390	
	M 15 45° (PR-2B) ³⁾	574522	
	M 18 45° (PR-2B) ³⁾	574524	
	M 22 45° (PR-2B) ³⁾	574526	
	M 28 45° (PR-2B) ³⁾	574528	
	M 35 45° (PR-2B) ³⁾	574530	
	Pegler Yorkshire XPress Stainless Gas	M 15	578312
		M 18 ¹⁾	578314
M 22		578316	
M 28 ¹⁾		578318	
M 35		578390	
M 15 45° (PR-2B) ³⁾		574522	
M 18 45° (PR-2B) ³⁾		574524	
M 22 45° (PR-2B) ³⁾		574526	
PERFEXIM "PERFEKT SYSTEM"	U 16	578374	
	U 20	578378	
	U 25	578380	
	U 32	578382	
PERFILTUBO PERFILALUPEX	U 16	578374	
	U 18	578376	
	U 20	578378	
	U 25	578380	
PERFILTUBO PERFILPRESS	U 32	578382	
	U 40	578386	
	M 15	578312	
	M 18	578314	
	M 22	578316	
	M 28	578318	
PEXTUBE PexTube	M 35	578390	
	M 15 45° (PR-2B) ³⁾	574522	
	M 18 45° (PR-2B) ³⁾	574524	
	M 22 45° (PR-2B) ³⁾	574526	
	M 28 45° (PR-2B) ³⁾	574528	
	M 35 45° (PR-2B) ³⁾	574530	
	RFz 16	578492	
	RFz 20	578494	
	RFz 25	578496	
	RFz 32	578498	
	Pipelife C-PRESS	M 15	578312
		M 18	578314
		M 22	578316
		M 28	578318
M 35		578390	
M 15 45° (PR-2B) ³⁾		574522	
M 18 45° (PR-2B) ³⁾		574524	
M 22 45° (PR-2B) ³⁾		574526	
M 28 45° (PR-2B) ³⁾		574528	
M 35 45° (PR-2B) ³⁾		574530	
Pipelife RADOPRESS	TH 16	578352	
	TH 18	578356	
	TH 20	578358	
	TH 26	578362	
	TH 32	578364	
	TH 40	578624	
Pipetec Connect	TH 16	578352	
	TH 20	578358	
	TH 26	578362	
	TH 32	578364	
	TH 40	578624	
	PLASTICA ALFA Multypex	H 16	578400
H 20		578406	
H 26		578410	
H 32		578412	
U 16		578374	
U 20		578378	
C 26		578392	
U 32		578382	

System	Pressing contour	Art.-No.	
PLASTICA ALFA Multypex Air	H 16	578400	
	H 20	578406	
	H 26	578410	
	H 32	578412	
	U 16	578374	
	U 20	578378	
	C 26	578392	
	U 32	578382	
	PLASTICA ALFA Multypexalfa Gas	H 16	578400
		H 20	578406
		H 26	578410
		H 32	578412
PLASTICA ALFA Multypexalfa Gas protek	H 16	578400	
	H 20	578406	
	H 26	578410	
	H 32	578412	
PLASTICA ALFA Multypex Plus	H 16	578400	
	H 20	578406	
	H 26	578410	
	H 32	578412	
	U 16	578374	
	U 20	578378	
	C 26	578392	
	U 32	578382	
PLASTICA ALFA Multypex Thermo	H 16	578400	
	H 20	578406	
	H 26	578410	
	H 32	578412	
PLASTICA ALFA Multypex Thermo Plus	U 16	578374	
	U 20	578378	
	C 26	578392	
	U 32	578382	
	H 16	578400	
	H 20	578406	
	H 26	578410	
	H 32	578412	
PLÁSTICOS FERRO FERROPLAST GPF GAS	RFz 16	578492	
	RFz 20	578494	
	RFz 25	578496	
	RFz 32	578498	
	PLUMBING PLUS EziPex Crimp (AUS)	K16/P18	578592
		K/20	578594
		K/25	578596
		K32	578598
	PLUMBING PLUS EziPex Gas (AUS)	K1/40	578600
		K16/P18	578592
		K/20	578594
		K/25	578596
PLUMBING PLUS EziPress Gas (AUS)	K32	578598	
	K1/40	578600	
	VAU 15 (OD 12,7 mm)	578630	
	VAU 20 (OD 19,1 mm)	578632	
PLUMBING PLUS EziPress Solar (AUS)	VAU 25 (OD 25,4 mm)	578634	
	VAU 32 (OD 31,8 mm)	578636	
	VAU 15 (OD 12,7 mm)	578630	
	VAU 20 (OD 19,1 mm)	578632	
PLUMBING PLUS EziPress Water (AUS)	VAU 25 (OD 25,4 mm)	578634	
	VAU 32 (OD 31,8 mm)	578636	
	VAU 15 (OD 12,7 mm)	578630	
	VAU 20 (OD 19,1 mm)	578632	
POLYPIPE POLYPRESS	VAU 25 (OD 25,4 mm)	578634	
	VAU 32 (OD 31,8 mm)	578636	
	F 16	578456	
	F 20	578460	
POLYPIPE POLYSURE	F 26	578462	
	F 32	578464	
	F 40	578478	
	TH 10	578342	
POLYSAN Handelsges. m.b.H. & Co KG (Krems/Öster- reich)	TH 15	578350	
	TH 22	578588	
	TH 28	578590	
	M 15	578312	
	M 18	578314	
	M 22	578316	
	M 28	578318	
	M 35	578390	
	M 15 45° (PR-2B) ³⁾	574522	
	M 18 45° (PR-2B) ³⁾	574524	
POLYSAN- C Stahl-Press- System M	M 22 45° (PR-2B) ³⁾	574526	
	M 28 45° (PR-2B) ³⁾	574528	
	M 35 45° (PR-2B) ³⁾	574530	
	V 15	578328	
POLYSAN Handelsges. m.b.H. & Co KG (Krems/Öster- reich)	V 18	578332	
	V 22	578334	
	V 28	578336	
	V 35	578604	
	V 15 45° (PR-2B) ³⁾	574504	
	V 18 45° (PR-2B) ³⁾	574506	
	V 22 45° (PR-2B) ³⁾	574508	
	V 28 45° (PR-2B) ³⁾	574510	

Pressfitting systems for gas installations must only be pressed with REMS pressing tongs Mini/pressing rings which are highlighted in yellow. Observe the national regulations.

- 1) Only pressing tongs from designation "108" (1st quarter of 2008), "208" (2nd quarter of 2008) etc. can be used. The designation is stamped on every pressing jaw.
- 2) For taking suitable pressing inserts.
- 3) Adapter tongs are required for driving pressing rings (PR), see page 136.

The suitability of REMS pressing tools for pressfitting systems: Date 09.10.2015. For the updated situation regarding suitability status check our website: www.rems.de → Downloads → Product catalogues, brochures → REMS Catalogue. Pressing tongs for additional pressfitting systems on request.

System	Pressing contour	Art.-No.
POLYSAN HandelsGES.	M 15	578312
m.b.H. & Co KG (Krems/Öster- reich)	M 18	578314
	M 22	578316
	M 28	578318
	M 35	578390
POLYSAN- Edelstahl	M 15 45° (PR-2B) ³⁾	574522
	M 18 45° (PR-2B) ³⁾	574524
Press-System Gas	M 22 45° (PR-2B) ³⁾	574526
	M 28 45° (PR-2B) ³⁾	574528
	M 35 45° (PR-2B) ³⁾	574530
POLYSAN HandelsGES.	M 15	578312
m.b.H. & Co KG (Krems/Öster- reich)	M 18	578314
	M 22	578316
	M 28	578318
	M 35	578390
POLYSAN- Edelstahl	M 15 45° (PR-2B) ³⁾	574522
	M 18 45° (PR-2B) ³⁾	574524
Press-System Wasser	M 22 45° (PR-2B) ³⁾	574526
	M 28 45° (PR-2B) ³⁾	574528
	M 35 45° (PR-2B) ³⁾	574530
POLYSAN HandelsGES.	TH 14	578348
m.b.H. & Co KG (Krems/Öster- reich)	TH 16	578352
	TH 17	578354
	TH 18	578356
	TH 20	578358
POLYSAN- Press-System	TH 26	578362
	TH 32	578364
	TH 40	578624
POLYSAN HandelsGES.	TH 14	578348
m.b.H. & Co KG (Krems/Öster- reich)	TH 16	578352
	TH 17	578354
	TH 18	578356
	TH 20	578358
POLYSAN-Henco- Press-System	TH 26	578362
POLYSAN (España)	U 16	578374
Rainbow	U 18	578376
	U 20	578378
	U 25	578380
	U 32	578382
	U 40	578386
Prandelli Multyrama Pf	H 14	578398
	H 16	578400
	H 18	578404
	H 20	578406
	H 26	578410
	H 32	578412
Prandelli Multyrama Pfm	H 16	578400
	H 18	578404
	H 20	578406
	H 26	578410
	H 32	578412
	TH 16	578352
	TH 18	578356
	TH 20	578358
	TH 26	578362
	TH 32	578364
	U 16	578374
	U 18	578376
	U 20	578378
Raccorderie Metalliche aesPRES ¹⁾	M 15	578312
	M 18	578314
	M 22	578316
	M 28	578318
Raccorderie Metalliche inoxPRES ¹⁾	M 15	578312
	M 18	578314
	M 22	578316
	M 28	578318
Raccorderie Metalliche steelPRES ¹⁾	M 15	578312
	M 18	578314
	M 22	578316
	M 28	578318
RBM Tita-gas	TH 16	578352
	TH 20	578358
	TH 26	578362
	TH 32	578364
RBM Tita-fix	B 14	578466
	B 16	578468
	B 18	578470
	B 20	578472
	B 26	578474
	F 16	578456
	F 18	578458
	F 20	578460
	H 14	578398
	H 16	578400
	H 18	578404
	H 20	578406
	H 26	578410
	H 32	578412
	TH 14	578348
	TH 16	578352
	TH 18	578356
	TH 20	578358
	TH 26	578362
	TH 32	578364
	TH 40	578624
	U 14	578372
	U 16	578374
	U 18	578376
	U 20	578378
Redi Nicoll Fluxo	TH 14	578348
	TH 16	578352
	TH 18	578356
	TH 20	578358
	TH 26	578362
	TH 32	578364
	TH 40	578624

System	Pressing contour	Art.-No.
Redi Nicoll Fluxo Gas	TH 16	578352
	TH 20	578358
	TH 26	578362
RIFENG U PRESS FITTING (F5)	U 14	578372
	U 16	578374
	U 18	578376
	U 20	578378
	U 25	578380
	U 32	578382
	U 40	578386
RIFENG TH PRESS FITTING (F9)	TH 16	578352
	TH 20	578358
	TH 25	578360
	TH 26	578362
	TH 32	578364
	TH 40	578624
RIQUIER A SERTIR	RFz 12	578490
	RFz 16	578492
	RFz 20	578494
	RFz 25	578496
Roth	RN 14	578434
	RN 17	578436
	RN 20	578438
	RN 25/26	578440
	RN 32	578442
Roth España - Global Plastic Rothapress	TH 16	578352
	TH 18	578356
	TH 20	578358
	TH 25	578360
	TH 32	578364
	TH 40	578624
Roth Nordic Alu-LaserPlus/ PressCheck (DNK-NOR-SWE-FIN)	RN 16	578454
	RN 20	578438
	RN 25/26	578440
	RN 32	578442
Rubinetteria Bresciane	M 15	578312
	M 18	578314
Bonomi	M 22	578316
TURBO INOX	M 28	578318
	M 35	578390
	M 15 45° (PR-2B) ³⁾	574522
	M 18 45° (PR-2B) ³⁾	574524
	M 22 45° (PR-2B) ³⁾	574526
	M 28 45° (PR-2B) ³⁾	574528
	M 35 45° (PR-2B) ³⁾	574530
Rubinetteria Bresciane	M 15	578312
	M 18	578314
Bonomi	M 22	578316
TURBO STEEL	M 28	578318
	M 35	578390
	M 15 45° (PR-2B) ³⁾	574522
	M 18 45° (PR-2B) ³⁾	574524
	M 22 45° (PR-2B) ³⁾	574526
	M 28 45° (PR-2B) ³⁾	574528
	M 35 45° (PR-2B) ³⁾	574530
Rubinetteria Bresciane	TH 14	578348
	TH 16	578352
Bonomi	TH 18	578356
TURBO PRESS	TH 20	578358
	TH 26	578362
	TH 32	578364
	TH 40	578624
Rubinetteria Bresciane	TH 16	578352
Bonomi	TH 20	578358
TURBO PRESS GAS	TH 26	578362
	TH 32	578364
SA.MI plastic	TH 14	578348
	TH 16	578352
	TH 18	578356
	TH 20	578358
	TH 26	578362
	TH 32	578364
	TH 40	578624
SA.MI plastic Multistrato Gas	TH 16	578352
	TH 20	578358
	TH 26	578362
	TH 32	578364
SANHA 3fit-Press Pb-free Serie 25000	B 16	578468
	B 20	578472
	B 26	578476
	B 32	578476
	F 16	578456
	F 20	578460
	F 26	578462
	F 32	578464
	F 40	578478
	H 16	578406
	H 20	578406
	H 26	578410
	H 32	578412
	TH 16	578352
	TH 20	578358
	TH 26	578362
	TH 32	578364
	TH 40	578624
	U 16	578374
	U 20	578378
	U 32	578382
	U 40	578386

System	Pressing contour	Art.-No.
SANHA	B 16	578468
3fit-Press PPSU Serie 35000	B 20	578472
	B 26	578474
	B 32	578476
	F 16	578456
	F 20	578460
	F 26	578462
	F 32	578464
	H 16	578406
	H 20	578406
	H 26	578410
	H 32	578412
	TH 16	578352
	TH 20	578358
	TH 26	578362
	TH 32	578364
	U 16	578374
	U 20	578378
	U 32	578382
SANHA-NiroSan Gas Presssystem Serie 17000	SA 15	578514
	SA 18	578518
	SA 22	578520
	SA 28	578522
	M 15 ¹⁾	578312
	M 18 ¹⁾	578314
	M 22 ¹⁾	578316
	M 28	578318
	M 35	578390
	M 15 45° (PR-2B) ³⁾	574522
	M 18 45° (PR-2B) ³⁾	574524
	M 22 45° (PR-2B) ³⁾	574526
	M 28 45° (PR-2B) ³⁾	574528
	M 35 45° (PR-2B) ³⁾	574530
	V 15 ¹⁾	578328
	V 18 ¹⁾	578332
	V 22 ¹⁾	578334
	V 28	578336
	V 35	578604
	V 15 45° (PR-2B) ³⁾	574504
	V 18 45° (PR-2B) ³⁾	574506
	V 22 45° (PR-2B) ³⁾	574508
	V 28 45° (PR-2B) ³⁾	574510
	V 35 45° (PR-2B) ³⁾	574512
SANHA-NiroSan Industry Presssystem Serie 18000	SA 15	578514
	SA 18	578518
	SA 22	578520
	SA 28	578522
	M 15 ¹⁾	578312
	M 18 ¹⁾	578314
	M 22 ¹⁾	578316
	M 28	578318
	M 35	578390
	M 15 45° (PR-2B) ³⁾	574522
	M 18 45° (PR-2B) ³⁾	574524
	M 22 45° (PR-2B) ³⁾	574526
	M 28 45° (PR-2B) ³⁾	574528
	M 35 45° (PR-2B) ³⁾	574530
	V 15 ¹⁾	578328
	V 18 ¹⁾	578332
	V 22 ¹⁾	578334
	V 28	578336
	V 35	578604
	V 15 45° (PR-2B) ³⁾	574504
	V 18 45° (PR-2B) ³⁾	574506
	V 22 45° (PR-2B) ³⁾	574508
	V 28 45° (PR-2B) ³⁾	574510
	V 35 45° (PR-2B) ³⁾	574512
SANHA-NiroSan- Presssystem Serie 9000	SA 15	578514
	SA 18	578518
	SA 22	578520
	SA 28	578522
	M 15 ¹⁾	578312
	M 18 ¹⁾	578314
	M 22 ¹⁾	578316
	M 28	578318
	M 35	578390
	M 15 45° (PR-2B) ³⁾	574522
	M 18 45° (PR-2B) ³⁾	574524
	M 22 45° (PR-2B) ³⁾	574526
	M 28 45° (PR-2B) ³⁾	574528
	M 35 45° (PR-2B) ³⁾	574530
	V 15 ¹⁾	578328
	V 18 ¹⁾	578332
	V 22 ¹⁾	578334
	V 28	578336
	V 35	578604
	V 15 45° (PR-2B) ³⁾	574504
	V 18 45° (PR-2B) ³⁾	574506
	V 22 45° (PR-2B) ³⁾	574508
	V 28 45° (PR-2B) ³⁾	574510
	V 35 45° (PR-2B) ³⁾	574512

REMS pressing tongs Mini REMS pressing rings

Accessories for REMS Mini-Press ACC and REMS Mini-Press 22 V ACC

System	Pressing contour	Art.-No.	
SANHA-Therm Industry Serie 28000	SA 12	578510	
	SA 15	578514	
	SA 18	578518	
	SA 22	578520	
	SA 28	578522	
	M 12	578310	
	M 15 ¹⁾	578312	
	M 18 ¹⁾	578314	
	M 22 ¹⁾	578316	
	M 28	578318	
	M 35	578390	
	M 12 45° (PR-2B) ³⁾	574520	
	M 15 45° (PR-2B) ³⁾	574522	
	M 18 45° (PR-2B) ³⁾	574524	
	M 22 45° (PR-2B) ³⁾	574526	
	M 28 45° (PR-2B) ³⁾	574528	
	M 35 45° (PR-2B) ³⁾	574530	
	V 12	578324	
	V 15 ¹⁾	578328	
	V 18 ¹⁾	578332	
	V 22 ¹⁾	578334	
	V 28	578336	
	V 35	578604	
	V 12 45° (PR-2B) ³⁾	574502	
	V 15 45° (PR-2B) ³⁾	574504	
	V 18 45° (PR-2B) ³⁾	574506	
	V 22 45° (PR-2B) ³⁾	574508	
	V 28 45° (PR-2B) ³⁾	574510	
	V 35 45° (PR-2B) ³⁾	574512	
	SATEC SK ViTerm	TH 16	578352
		TH 18	578356
		TH 20	578358
TH 26		578362	
TH 32		578364	
U 40		578386	
Schwer Fittings AQUApress	M 12	578310	
	M 15	578312	
	M 18	578314	
	M 22	578316	
	M 28	578318	
	M 35	578390	
M 12 45° (PR-2B) ³⁾	574520		
M 15 45° (PR-2B) ³⁾	574522		
M 18 45° (PR-2B) ³⁾	574524		
M 22 45° (PR-2B) ³⁾	574526		
M 28 45° (PR-2B) ³⁾	574528		
M 35 45° (PR-2B) ³⁾	574530		
Seppelfricke VSH SudoPress C-Stahl Visu-Control	V 12	578324	
	V 15	578328	
	V 18	578332	
	V 22	578334	
Seppelfricke VSH SudoPress Edelstahl Visu-Control	V 15	578328	
	V 18	578332	
	V 22	578334	
	V 28	578336	
Seppelfricke VSH SudoPress Kupfer Visu-Control	V 12	578324	
	V 15	578328	
	V 18	578332	
	V 22	578334	
Seppelfricke VSH SudoPress Kupfer Gas Visu-Control	V 15	578328	
	V 18	578332	
	V 22	578334	
	V 28	578336	
Seppelfricke VSH SudoPress Kupfer Solar Visu-Control	V 15	578328	
	V 18	578332	
	V 22	578334	
	V 28	578336	
Seppelfricke SkinPress Visu-Control	TH 14	578348	
	TH 16	578352	
	TH 18	578356	
	TH 20	578358	
	TH 26	578362	
	THL 32	578368	
Seppelfricke VSH XPress C-Stahl	M 12	578310	
	M 15	578312	
	M 18 ¹⁾	578314	
	M 22	578316	
	M 28 ¹⁾	578318	
	M 35	578390	
	M 12 45° (PR-2B) ³⁾	574520	
	M 15 45° (PR-2B) ³⁾	574522	
	M 18 45° (PR-2B) ³⁾	574524	
	M 22 45° (PR-2B) ³⁾	574526	
	M 28 45° (PR-2B) ³⁾	574528	
	M 35 45° (PR-2B) ³⁾	574530	
Seppelfricke VSH XPress Edelstahl	M 15	578312	
	M 18 ¹⁾	578314	
	M 22	578316	
	M 28 ¹⁾	578318	
	M 35	578390	
	M 15 45° (PR-2B) ³⁾	574522	
	M 18 45° (PR-2B) ³⁾	574524	
	M 22 45° (PR-2B) ³⁾	574526	
	M 28 45° (PR-2B) ³⁾	574528	
	M 35 45° (PR-2B) ³⁾	574530	
	Seppelfricke VSH XPress Edelstahl gas	M 15	578312
		M 18 ¹⁾	578314
M 22		578316	
M 28 ¹⁾		578318	
M 35		578390	
M 15 45° (PR-2B) ³⁾		574522	
M 18 45° (PR-2B) ³⁾		574524	
M 22 45° (PR-2B) ³⁾		574526	
M 28 45° (PR-2B) ³⁾		574528	
M 35 45° (PR-2B) ³⁾		574530	

System	Pressing contour	Art.-No.	
Seppelfricke VSH XPress Kupfer	M 12	578310	
	M 15	578312	
	M 18 ¹⁾	578314	
	M 22	578316	
	M 28 ¹⁾	578318	
	M 35	578390	
	V 12 45° (PR-2B) ³⁾	574502	
	V 15 45° (PR-2B) ³⁾	574504	
	V 18 45° (PR-2B) ³⁾	574506	
	V 22 45° (PR-2B) ³⁾	574508	
	V 28 45° (PR-2B) ³⁾	574510	
	V 35 45° (PR-2B) ³⁾	574512	
	Seppelfricke VSH XPress Kupfer gas	M 15	578312
		M 18 ¹⁾	578314
		M 22	578316
		M 28 ¹⁾	578318
M 35		578390	
SESTA SESTA GAS	TH 14	578348	
	TH 16	578352	
	TH 20	578358	
	TH 26	578362	
	TH 32	578364	
SESTA sistema multistrato	H 16	578400	
	H 20	578406	
	TH 14	578348	
	TH 16	578352	
	TH 18	578356	
	TH 20	578358	
	TH 26	578362	
	TH 32	578364	
	TH 40	578624	
	U 16	578374	
SLOVARM PEX-THERM	U 16	578374	
	U 20	578378	
	H 26	578410	
	U 32	578382	
	H 16	578400	
	H 20	578406	
SOMATHERM MULTIX	H 26	578410	
	H 32	578412	
	TH 16	578352	
	TH 20	578358	
	TH 26	578362	
	TH 32	578364	
	U 16	578374	
	U 20	578378	
	U 32	578382	
	H 16	578400	
	H 20	578406	
	SOMATHERM SomaPRESS	H 12	578396
H 16		578400	
H 20		578406	
H 25		578408	
RFz 12		578490	
RFz 16		578492	
RFz 20		578494	
RFz 25		578496	
U 16		578374	
U 20		578378	
STANDARD HIDRAULICA MultiStandard	U 16	578374	
	U 18	578376	
	U 20	578378	
	U 25	578380	
	U 32	578382	
	U 40	578386	
	H 16	578400	
STELBI Polikraft	H 20	578406	
	H 26	578410	
	TH 16	578352	
	TH 20	578358	
	TH 26	578362	
	TH 32	578364	
	TH 40	578624	
	U 16	578374	
	U 20	578378	
	STELBI Stelgas	TH 16	578352
TH 20		578358	
TH 26		578362	
TH 32		578364	
System WELCO-Gas	H 16 A	578420	
	H 20 A	578426	
	H 26 A	578430	
	H 32 A	578432	
	System WELCO-Flex	H 14 A	578418
H 16 A		578420	
H 17 A		578422	
H 20 A		578426	
H 26 A		578430	
H 32 A		578432	
System WELCO-Teck	H 16 A	578420	
	H 20 A	578426	
	H 26 A	578430	
	H 32 A	578432	
TDM BRASS Serie 1600	TH 16	578352	
	TH 18	578356	
	TH 20	578358	
	TH 26	578362	
	THL 32	578368	
	H 16	578400	
	H 18	578404	
	H 20	578406	
	H 26	578410	
	H 32	578412	
	U 16	578374	
	U 18	578376	
TDM BRASS Serie 1700 (Gas)	U 20	578378	
	C 26	578392	
	U 32	578382	
	TH 16	578352	
	TH 20	578358	
	TH 26	578362	
	THL 32	578368	

System	Pressing contour	Art.-No.
TERMICALINE Termipex	B 16	578468
	B 20	578472
	B 26	578474
	B 32	578476
	H 16	578400
	H 20	578406
	TH 16	578352
	TH 20	578358
	TH 26	578362
	TH 32	578364
	U 16	578374
	U 20	578378
TermoConcept TC-PRESS	Basic E01 ²⁾	578618
THERMOLUTZ	H 14	578398
	H 16	578400
	H 17	578402
	TH 20	578358
TE-SA TE-SA press serie 800	TH 14	578348
	TH 16	578352
	TH 18	578356
	TH 20	578358
	TH 26	578362
	TH 32	578364
TIEMME AL-COBRAPEX Serie 1650	TH 40	578624
	TH 14	578348
	TH 16	578352
	TH 18	578356
	TH 20	578358
	TH 25	578360
TIEMME Serie 1700 PE-X a pressare	TH 26	578362
	THL 32	578368
	TH 40	578624
	RFz 12	578490
	RFz 16	578492
	RFz 20	578494
TIEMME TIEMME Gas	RFz 25	578496
	RFz 32	578498
	TH 16	578352
	TH 20	578358
	TH 26	578362
TIGRE ALPEX GAS	THL 32	578368
	TH 16	578352
	TH 20	578358
	TH 26	578362
TKM Systemtechnik	TH 32	578364
	TH 40	578624
	TH 14	578348
	TH 16	578352
	TH 20	578358
	TH 26	578362
TRA MULTITRAPRESS	TH 32	578364
	TH 40	578624
	U 16	578374
	U 18	578376
	U 20	578378
	U 25	578380
TRA TRAPRESS	U 32	578382
	U 40	578386
	H 12	578396
	H 16	578400
	H 20	578406
	H 25	578408
TWEETOP	H 32	578412
	RFz 12	578490
	RFz 16	578492
	RFz 20	578494
	RFz 25	578496
	RFz 32	578498
UNICAL AG MAX-MULTIPEX	U 16	578374
	U 20	578378
	H 26	578410
	U 32	578382
UNIDELTA DeltaII	TH 16	578352
	TH 20	578358
	TH 26	578362
	TH 32	578364
	TH 40	578624
	H 16	578400
UNIDELTA DeltaII GAS	H 20	578406
	H 26	578410
	H 32	578412
	U 16	578374
	U 20	578378
	U 32	578382
	U 40	578386
	TH 16	578352
	TH 20	578358
	TH 26	578362
	TH 32	578364
	TH 40	578624
Uponor MLC	H 16	578400
	H 20	578406
	H 26	578410
	H 32	578412
	U 16	578374
	U 20	578378
	U 32	578382
	U 40	578386
Uponor MLC-D	UP 14	578576
	UP 16	578578
	UP 18	578580
	UP 20	578582
	UP 25	578584
Uponor MLC-G	UP 32	578586
	UP 40	578588
	UP 20	578582
	UP 25	578584
	UP 32	578586

System	Pressing contour	Art.-No.	
Uponor Uni Pipe PLUS	UP 16	578578	
	UP 20	578582	
	UP 25	578584	
	UP 32	578586	
Valsir PEXAL	H 14	578398	
	H 16	578400	
	H 20	578406	
	H 26	578410	
	H 32 V	578602	
Valsir PEXAL Gas	H 14	578398	
	H 16	578400	
	H 20	578406	
	H 26	578410	
Van Marcke Log. Tu-Bi-Pex	TH 16	578352	
	TH 17	578354	
	TH 20	578358	
	TH 26	578362	
	TH 32	578364	
Van Marcke Log. Tu-Bi-Press	M 12	578310	
	M 15	578312	
	M 18	578314	
	M 22	578316	
	M 28	578318	
	M 35	578390	
	M 12 45° (PR-2B) ³⁾	574520	
	M 15 45° (PR-2B) ³⁾	574522	
	M 18 45° (PR-2B) ³⁾	574524	
	M 22 45° (PR-2B) ³⁾	574526	
	M 28 45° (PR-2B) ³⁾	574528	
	M 35 45° (PR-2B) ³⁾	574530	
Variotherm System TH	TH 11.6	578344	
	TH 16	578352	
	TH 20	578358	
Viega Fonterra	VX 12	578550	
	VP 14/15	578480	
	VP 16/17	578482	
	VP 20	578484	
	VP 25	578486	
Viega Pexfit	VX 16	578552	
	VX 20	578554	
	VX 25	578556	
Viega Pexfit G	VX 16	578552	
	VX 20	578554	
	VX 25	578556	
	Viega Prestabo	V 12	578324
		V 15	578328
		V 18	578332
		V 22	578334
		V 28	578336
		V 12 45° (PR-2B) ³⁾	574502
V 15 45° (PR-2B) ³⁾		574504	
V 18 45° (PR-2B) ³⁾		574506	
V 22 45° (PR-2B) ³⁾		574508	
V 28 45° (PR-2B) ³⁾		574510	
Viega Profipress		V 12	578324
		VG 14	578338
	V 15	578328	
	VG 16	578340	
	V 18	578332	
	V 22	578334	
	V 28	578336	
	V 35	578604	
	V 12 45° (PR-2B) ³⁾	574502	
	VG 14 45° (PR-2B) ³⁾	574536	
	V 15 45° (PR-2B) ³⁾	574504	
	VG 16 45° (PR-2B) ³⁾	574538	
	V 18 45° (PR-2B) ³⁾	574506	
	V 22 45° (PR-2B) ³⁾	574508	
	V 28 45° (PR-2B) ³⁾	574510	
	V 35 45° (PR-2B) ³⁾	574512	
	Viega Profipress G	V 12	578324
		V 15	578328
		V 18	578332
V 22		578334	
V 28		578336	
V 35		578604	
V 12 45° (PR-2B) ³⁾		574502	
V 15 45° (PR-2B) ³⁾		574504	
V 18 45° (PR-2B) ³⁾		574506	
V 22 45° (PR-2B) ³⁾		574508	
V 28 45° (PR-2B) ³⁾		574510	
V 35 45° (PR-2B) ³⁾		574512	
Viega Profipress S		V 12	578324
		V 15	578328
	V 18	578332	
	V 22	578334	
	V 28	578336	
	V 35	578604	
	V 12 45° (PR-2B) ³⁾	574502	
	V 15 45° (PR-2B) ³⁾	574504	
	V 18 45° (PR-2B) ³⁾	574506	
	V 22 45° (PR-2B) ³⁾	574508	
	V 28 45° (PR-2B) ³⁾	574510	
	V 35 45° (PR-2B) ³⁾	574512	
	Viega Profipress Therm	V 12	578324
		V 15	578328
V 18		578332	
V 22		578334	
V 12 45° (PR-2B) ³⁾		574502	
V 15 45° (PR-2B) ³⁾		574504	
Viega ProPress System USA	VUS 1/2" (OD 15.9 mm)	578566	
	VUS 3/4" (OD 22.2 mm)	578568	
	VUS 1" (OD 28.6 mm)	578570	
	VUS 1 1/4" (OD 34.9 mm)	578606	

System	Pressing contour	Art.-No.
Viega Propress WATER System AUS	VAU 15 (OD 12.7 mm)	578630
	VAU 20 (OD 19.1 mm)	578632
	VAU 25 (OD 25.4 mm)	578634
	VAU 32 (OD 31.8 mm)	578636
	VAU 15 (OD 12.7 mm)	578630
Viega PropressG GAS System AUS	VAU 20 (OD 19.1 mm)	578632
	VAU 25 (OD 25.4 mm)	578634
	VAU 32 (OD 31.8 mm)	578636
	VRX 16	578640
Viega Raxofix	VRX 20	578642
	VRX 25	578644
	VRX 32	578646
	VP 16/17	578482
Viega Sanfix	VP 20	578484
	VP 25	578486
	VP 32	578488
	V 12	578324
	V 15	578328
Viega Sanpress	V 18	578332
	V 22	578334
	V 28	578336
	V 35	578604
	V 12 45° (PR-2B) ³⁾	574502
	V 15 45° (PR-2B) ³⁾	574504
	V 18 45° (PR-2B) ³⁾	574506
	V 22 45° (PR-2B) ³⁾	574508
	V 28 45° (PR-2B) ³⁾	574510
	V 35 45° (PR-2B) ³⁾	574512
	V 15	578328
	Viega Sanpress Inox	V 18
V 22		578334
V 28		578336
V 35		578604
V 15 45° (PR-2B) ³⁾		574504
Viega Sanpress Inox G	V 18 45° (PR-2B) ³⁾	574506
	V 22 45° (PR-2B) ³⁾	574508
	V 28 45° (PR-2B) ³⁾	574510
	V 35 45° (PR-2B) ³⁾	574512
	V 15	578328
	V 18	578332
	V 22	578334
	V 28	578336
	V 35	578604
Viessmann	TH 14	578348
	TH 16	578352
	TH 20	578358
	TH 26	578362
	TH 32	578364
	U 14	578372
VSH MultiPress	U 16	578374
	U 20	578378
	U 25	578380
	U 32	578382
	U 40	578386
	V 12	578324
VSH SudoPress Carbon V	V 15	578328
	V 18	578332
	V 22	578334
	V 28	578336
	V 35	578604
	V 12	578324
	V 14	578326
	V 15	578328
VSH SudoPress Copper V	V 16	578330
	V 18	578332
	V 22	578334
	V 28	578336
	V 35	578604
	V 12	578324
	V 14	578326
	V 15	578328
	V 16	578330
	V 18	578332
	VSH SudoPress Copper Gas	V 22
V 28		578336
V 35		578604
V 14		578326
V 15		578328
V 16		578330
V 18		578332
V 22		578334
V 28		578336
V 35		578604
VSH SudoPress Copper Solar	V 14	578326
	V 15	578328
	V 16	578330
	V 18	578332
	V 22	578334
	V 15	578328
	V 18	578332
VSH SudoPress Stainless	V 22	578334
	V 28	578336
	V 35	578604
	TH 14	578348
	TH 16	578352
	TH 18	578356
VSH SkinPress	TH 20	578358
	TH 26	578362
	THL 32	578368
	TH 40	578624

System	Pressing contour	Art.-No.
VSH SkinPress Gas	TH 16	578352
	TH 20	578358
	TH 26	578362
	THL 32	578368
VSH XPress Carbon	M 12	578310
	M 15	578312
	M 18 ¹⁾	578314
	M 22	578316
	M 28 ¹⁾	578318
	M 35	578390
	M 12 45° (PR-2B) ³⁾	574520
	M 15 45° (PR-2B) ³⁾	574522
	M 18 45° (PR-2B) ³⁾	574524
	M 22 45° (PR-2B) ³⁾	574526
	M 28 45° (PR-2B) ³⁾	574528
	M 35 45° (PR-2B) ³⁾	574530
VSH XPress Copper	M 12	578310
	M 15	578312
	M 18 ¹⁾	578314
	M 22	578316
	M 28 ¹⁾	578318
	M 35	578390
	M 12 45° (PR-2B) ³⁾	574520
	M 15 45° (PR-2B) ³⁾	574522
	M 18 45° (PR-2B) ³⁾	574524
	M 22 45° (PR-2B) ³⁾	574526
	M 28 45° (PR-2B) ³⁾	574528
	M 35 45° (PR-2B) ³⁾	574530
VSH XPress Copper GAS	M 15	578312
	M 18 ¹⁾	578314
	M 22	578316
	M 28 ¹⁾	578318
	M 35	578390
	M 15 45° (PR-2B) ³⁾	574522
VSH XPress Copper Solar	M 18 45° (PR-2B) ³⁾	574524
	M 22 45° (PR-2B) ³⁾	574526
	M 28 45° (PR-2B) ³⁾	574528
	M 35 45° (PR-2B) ³⁾	574530
	M 15	578312
	M 18 ¹⁾	578314
	M 22	578316
	M 28 ¹⁾	578318
	M 35	578390
	M 15 45° (PR-2B) ³⁾	574522
	M 18 45° (PR-2B) ³⁾	574524
	M 22 45° (PR-2B) ³⁾	574526
VSH XPress Stainless	M 28 45° (PR-2B) ³⁾	574528
	M 35 45° (PR-2B) ³⁾	574530
	M 15	578312
	M 18 ¹⁾	578314
	M 22	578316
	M 28 ¹⁾	578318
	M 35	578390
	M 15 45° (PR-2B) ³⁾	574522
	M 18 45° (PR-2B) ³⁾	574524
	M 22 45° (PR-2B) ³⁾	574526
	M 28 45° (PR-2B) ³⁾	574528
	M 35 45° (PR-2B) ³⁾	574530
VSH XPress Stainless Gas	M 15	578312
	M 18 ¹⁾	578314
	M 22	578316
	M 28 ¹⁾	578318
	M 35	578390
	M 15 45° (PR-2B) ³⁾	574522
	M 18 45° (PR-2B) ³⁾	574524
	M 22 45° (PR-2B) ³⁾	574526
	M 28 45° (PR-2B) ³⁾	574528
	M 35 45° (PR-2B) ³⁾	574530
	Walter Meier Metalplast	U 16
U 18		578376
U 20		578378
U 25		578380
U 32		578382
U 40		578386
TH 16		578352
TH 20		578358
Watts MTR Art press	TH 26	578362
	TH 32	578364
	US 3/4"	578534
	US 1"	578540
WATTS RADIANT	US 3/4"	578534
	US 1/2"	578536
	US 3/4"	578538
Watts WaterPEX	US 1"	578540
	US 3/4"	578534
	US 1/2"	578536
	US 3/4"	578538
Watts RadiantPEX	US 1"	578540
	U 16 (1/2")	578374
	U 20 (3/4")	578378
Watts RadiantPEX-AL	U 25 (3/4")	578380
	U 32 (1")	578382
	U 14	578372
Wavin	U 16	578374
	U 20	578378
	U 25	578380
	U 32	578382
	U 40	578386
Wavin Tigris M1	U 14	578372
	U 16	578374
	U 20	578378
	U 25	578380
	U 32	578382

Pressfitting systems for gas installations must only be pressed with REMS pressing tongs Mini/pressing rings which are highlighted in yellow. Observe the national regulations.

¹⁾ Only pressing tongs from designation "108" (1st quarter of 2008), "208" (2nd quarter of 2008) etc. can be used. The designation is stamped on every pressing jaw.

²⁾ For taking suitable pressing inserts.

³⁾ Adapter tongs are required for driving pressing rings (PR), see page 136.

The suitability of REMS pressing tools for pressfitting systems: Date 09.10.2015. For the updated situation regarding suitability status check our website:

www.rems.de → Downloads → Product catalogues, brochures → REMS Catalogue.

Pressing tongs for additional pressfitting systems on request.

System	Pressing contour	Art.-No.	
WeeConPress Alu	M 12	578310	
	M 15	578312	
	M 18	578314	
	M 22	578316	
	M 28	578318	
	M 35	578390	
	M 12 45° (PR-2B) ³⁾	574520	
	M 15 45° (PR-2B) ³⁾	574522	
	M 18 45° (PR-2B) ³⁾	574524	
	M 22 45° (PR-2B) ³⁾	574526	
	M 28 45° (PR-2B) ³⁾	574528	
	M 35 45° (PR-2B) ³⁾	574530	
	V 12	578324	
	V 15	578328	
	V 18	578332	
	V 22	578334	
	V 28	578336	
	V 35	578604	
	V 12 45° (PR-2B) ³⁾	574502	
	V 15 45° (PR-2B) ³⁾	574504	
	V 18 45° (PR-2B) ³⁾	574506	
	V 22 45° (PR-2B) ³⁾	574508	
	V 28 45° (PR-2B) ³⁾	574510	
	V 35 45° (PR-2B) ³⁾	574512	
	SA 12	578510	
	SA 15	578514	
	SA 18	578518	
	SA 22	578520	
	SA 28	578522	
	WeeConPress C-Stahl	M 12	578310
		M 15	578312
		M 18	578314
		M 22	578316
M 28		578318	
M 35		578390	
M 12 45° (PR-2B) ³⁾		574520	
M 15 45° (PR-2B) ³⁾		574522	
M 18 45° (PR-2B) ³⁾		574524	
M 22 45° (PR-2B) ³⁾		574526	
M 28 45° (PR-2B) ³⁾		574528	
M 35 45° (PR-2B) ³⁾		574530	
WeeConPress Inox		M 12	578310
		M 15	578312
		M 18	578314
	M 22	578316	
	M 28	578318	
	M 35	578390	
	M 12 45° (PR-2B) ³⁾	574520	
	M 15 45° (PR-2B) ³⁾	574522	
	M 18 45° (PR-2B) ³⁾	574524	
	M 22 45° (PR-2B) ³⁾	574526	
	M 28 45° (PR-2B) ³⁾	574528	
	M 35 45° (PR-2B) ³⁾	574530	

System	Pressing contour	Art.-No.	
WeeConPress Kupfer	M 12	578310	
	M 15	578312	
	M 18	578314	
	M 22	578316	
	M 28	578318	
	M 35	578390	
	M 12 45° (PR-2B) ³⁾	574520	
	M 15 45° (PR-2B) ³⁾	574522	
	M 18 45° (PR-2B) ³⁾	574524	
	M 22 45° (PR-2B) ³⁾	574526	
	M 28 45° (PR-2B) ³⁾	574528	
	M 35 45° (PR-2B) ³⁾	574530	
	WeeConFlex MVR	H 16	578400
		H 20	578406
		H 26	578410
		H 32	578412
		U 40	578386
		TH 16	578352
TH 20		578358	
TH 26		578362	
TH 32		578364	
TH 40		578624	
WEM		U 16	578374
WIELAND cuprotherm CTX		TH 14	578348
	TH 16	578352	
	TH 18	578356	
	TH 20	578358	
	TH 26	578362	
	WKS-Press	TH 14	578348
TH 16		578352	
TH 17		578354	
TH 20		578358	
TH 26		578362	
TH 32		578364	
TH 40		578624	
XtraConnect		F 16	578456
		F 20	578460
		F 26	578462
	F 32	578464	
	H 16	578400	
	H 20	578406	
	H 26	578410	
	H 32	578412	
	TH 16	578352	
	TH 20	578358	
	TH 26	578362	
	TH 32	578364	
(DN 26)	U 16	578374	
	U 20	578378	
	U 25	578380	
	U 32	578382	
	VP 16	578482	
	VP 20	578484	
	VP 32	578488	

System	Pressing contour	Art.-No.	
Zetaesse Multistrato EUROPEX	TH 14	578348	
	TH 16	578352	
	TH 18	578356	
	TH 20	578358	
	TH 26	578362	
	TH 32	578364	
	U 14	578372	
	U 16	578374	
	U 18	578376	
	U 20	578378	
	Zetaesse Multistrato ISOPEX	TH 14	578348
		TH 16	578352
TH 18		578356	
TH 20		578358	
TH 26		578362	
TH 32		578364	
Zetaesse Rame HydroSAN	U 14	578372	
	U 16	578374	
	U 18	578376	
	U 20	578378	
	TH 14	578348	
	TH 16	578352	
Zetaesse Rame ThermoSAN	TH 20	578358	
	TH 26	578362	
	U 14	578372	
	U 16	578374	
	U 20	578378	
	ZEWOTHERM	TH 12	578346
TH 16		578352	
TH 17		578354	
TH 18		578356	
TH 20		578358	
TH 26		578362	
ZURN INDUSTRIES ZURN PEX	US ¾"	578534	
	US ½"	578536	
	US ¾"	578538	
	US 1"	578540	

REMS pressing tongs Mini

REMS pressing tongs Mini with 2 swivellable monoblock pressing jaws.

REMS pressing ring 45° (PR-2B)

REMS pressing ring 45° (PR-2B) with 2 pressing jaws for pressings at places of difficult access, with Mini Z1 adapter tongs.

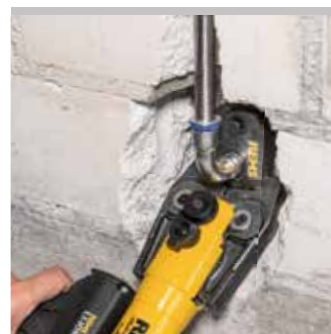

Pressfitting systems for gas installations must only be pressed with REMS pressing tongs Mini/pressing rings which are highlighted in yellow. Observe the national regulations.

- Only pressing tongs from designation "108" (1st quarter of 2008), "208" (2nd quarter of 2008) etc. can be used. The designation is stamped on every pressing jaw.
- For taking suitable pressing inserts.
- Adapter tongs are required for driving pressing rings (PR), see page 136.

The suitability of REMS pressing tools for pressfitting systems: Date 09.10.2015. For the updated situation regarding suitability status check our website: www.rems.de → Downloads → Product catalogues, brochures → REMS Catalogue. Pressing tongs for additional pressfitting systems on request.

Accessories

Description	Art.-No.
Adapter tongs Mini Z1 for driving REMS pressing rings 45° (PR-2B)	578558
Steel case with insert for adapter tongs Mini Z1 and adapter tongs Z1 and 6 REMS pressing rings V 12–35 45° (PR-2B) or M 12–35 45° (PR-2B)	574516
Steel case with insert for 8 pressing tongs Mini/cropping tongs Mini and compartment for pipe cutter up to 42 mm	578295



REMS cropping tongs Mini

Accessories for REMS Mini-Press ACC and
REMS Mini-Press 22 V ACC

High performance cropping tongs Mini in forged and specially hardened steel for cutting threaded rods.

Steel, stainless steel up to
hardness classification 4.8 (400 N/mm²) M 6–M 10

REMS cropping tongs Mini – cuts in just 2 seconds!

Made of forged and specially hardened steel.

Reversible cropping inserts for double service life.

M cropping inserts with high precision thread contour machined on CNC machining centres for exact guiding of the threaded rod in the cutting process. Pliers parts, cropping inserts and specially machined and hardened cutting edges, made to fit exactly, for cutting without burr.

Threaded rod can be screwed into a threaded connection of the pipe clip or the nut without rework after cutting.

Cutting device in pliers design (**Patent EP 1 459 825, patent US 7,284,330**). Very compact design and low weight of the REMS Mini cropping tongs due to special arrangement of the cropping tongs connection (**Patent EP 1 952 948**). Recesses in the connecting plate for safe guidance of the connecting lugs for offset-free pressing (**Patent EP 2 347 862**).

Driven by REMS Mini-Press ACC and REMS Mini-Press 22 V ACC.

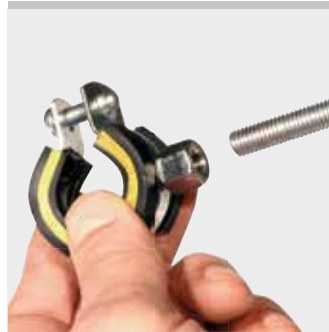
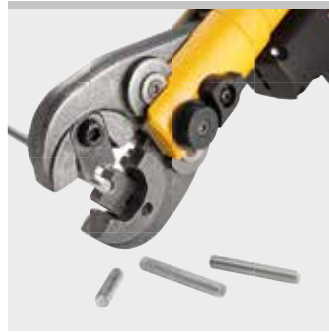

German Quality Product



Patent EP 1 952 948
Patent EP 1 459 825
Patent US 7,284,330
Patent EP 2 347 862

Supply format

REMS cropping tongs Mini. Cropping tongs with 1 pair of reversible cropping inserts for steel, stainless steel, M 6–M 10. In a carton.

Description	for threaded rods	Art.-No.	
REMS cropping tongs Mini M 6	M 6	578620	
REMS cropping tongs Mini M 8	M 8	578621	
REMS cropping tongs Mini M 10	M 10	578622	

Accessories

Description	for threaded rods	Art.-No.	
Cropping inserts M 6 (pair)	M 6	571891	
Cropping inserts M 8 (pair)	M 8	571896	
Cropping inserts M 10 (pair)	M 10	571866	
Steel case with insert for 8 pressing tongs Mini/cropping tongs Mini and compartment for pipe cutter up to 42 mm		578295	



Universal, manual radial press for producing pipe pressing joints for all common pressfitting systems.

Pressing joints with plastic and multi-layer composite tubes \varnothing 10–26 mm
 \varnothing $\frac{3}{8}$ –1"

Complete range of REMS pressing tongs for all common pressfitting systems, see page 144–160.

REMS Eco-Press – universal up to \varnothing 26 mm.
Secure crimping in seconds.

System advantage

Only **one** type of pressing tongs for all REMS radial presses (except for REMS Mini-Press ACC, REMS Mini-Press 22 V ACC) and radial presses of other makes.

All pressing tongs marked by a * have another connection (**Patent EP 1 223 008, Patent US 6,739,172**) and also fit the manual radial press REMS Eco-Press. Thus simple, inexpensive stocking.

Pressing tongs for all common systems

Complete assortment of REMS pressing tongs for all common pressfitting systems (page 144–160). High-compression pressing tongs in forged and specially hardened steel. Pressing contours of REMS pressing tongs are system-specific and correspond to the respective pressfitting system. Thus perfect system-conformity, safe press jointing.

Design

Compact, handy, light. Drive unit with short tubular arms only 1.6 kg. Works anywhere, free-hand, overhead, in confined areas. Secure seating of pressing tongs through locking pins. Dividable tubular arms for individual adjustment of leverage to accommodate different force demands of different pressfitting systems.

Pressing operation

A perfect joint is achieved when pressing tongs close completely. Final-lock-positioning, the pressing jaws remain in a closed position until opening. This way, the perfect pressing joint (completely closed pressing jaws) can be observed.



German Quality Product



Supply format

REMS Eco-Press drive unit. Manual radial press with final-lock-positioning for producing pressing joints of plastic and multi-layer composite tubes \varnothing 10–26 mm, \varnothing $\frac{3}{8}$ –1". For operating with REMS pressing tongs. With dividable tubular arms. In skin package.

	Art.-No.
	574000



Accessories

Description	Art.-No.
REMS pressing tongs/pressing rings see page 144–160.	
REMS cropping tongs for threaded rods see page 163.	
Carrying bag for drive unit and for 3 pressing tongs	574436
Steel case with insert for drive unit and for 3 pressing tongs	574430



REMS Power-Press SE

Electric radial press

Universal, handy electric tool for producing pipe pressing joints for all common pressfitting systems.

Pipe pressing joints \varnothing 10–108 (110) mm
 \varnothing $\frac{3}{8}$ –4"

Complete range of REMS pressing tongs/pressing rings for all common pressfitting systems, see page 144–160.

REMS Power-Press SE – universal up to \varnothing 110 mm.
Secure crimping in seconds.
Automatic locking of pressing tongs.

System advantage

Only **one** type of pressing tongs/pressing rings for all REMS radial presses (except for REMS Mini-Press ACC, REMS Mini-Press 22V ACC) and radial presses of other makes.

All pressing tongs marked by a * have another connection (**Patent EP 1 223 008, Patent US 6,739,172**) and also fit the manual radial press REMS Eco-Press. Thus simple, inexpensive stocking.

Pressing tongs/pressing rings for all common systems

Complete assortment of REMS pressing tongs/pressing rings for all common pressfitting systems (page 144–160). High-compression pressing tongs/pressing rings in forged and specially hardened steel. Pressing contours of REMS pressing tongs/pressing rings are system-specific and correspond to the respective pressfitting system. Thus perfect systemconformity, safe press jointing.

Design

Compact, robust, job site-proven. Small in size, slender design, drive unit only 4.7 kg. Works anywhere, free-hand, overhead, in confined areas. Secure seating of pressing tongs/adaptor tongs by automatic locking. Also suitable for other suitable makes of pressing tongs/pressing chains.

Pressing operation by touch-control

For reliable service, operating and functional safety. A perfect joint is achieved when pressing tongs close completely. The pressing tongs remain in a closed position until machine is switched and runs into reverse. The perfect pressing joint (completely closed pressing jaws) can be observed.

Drive

Enormous thrust and pressing force for fast and perfect press jointing. Powerful electro-mechanical drive with proven universal motor, 450 W, maintenance-free gear with safety slipping clutch and in-feed system with machine screw spindle. Overload protection. Safety tip switch.



Tested by electrosuisse >>>

German Quality Product



Supply format

REMS Power-Press SE Basic-Pack. Electric radial press for producing pressing joints \varnothing 10–108 (110) mm, \varnothing $\frac{3}{8}$ –4". For driving REMS pressing tongs/pressing rings and other suitable makes of pressing tongs/pressing rings. Pressing tongs seat with automatic locking. Electro-mechanical drive with proven universal motor 230 V or 110 V, 50–60 Hz, 450 W, maintenance-free gear with safety slipping clutch and in-feed system with machine screw spindle, overload protection, safety tip switch. In sturdy steel case.

	Art.-No.
	572111

Other voltages on request.



Accessories

Description	Art.-No.
REMS Power-Press SE Drive Unit	572101
REMS pressing tongs/pressing rings see page 144–160.	
REMS cropping tongs for threaded rods see page 163.	
REMS cable shear for electric cable see page 163.	
Steel case with insert	570280



REMS Power-Press

Electro-hydraulic radial press with switch-off signal

Universal, handy electric tool with switch-off signal for producing pipe pressing joints for all common pressfitting systems.

Pipe pressing joints \varnothing 10–108 (110) mm
 \varnothing $\frac{3}{8}$ –4"

Complete range of REMS pressing tongs/pressing rings for all common pressfitting systems, see page 144–160.

REMS Power-Press – universal up to \varnothing 110 mm.
Secure crimping in seconds.
Automatic locking of pressing tongs.

System advantage

Only **one** type of pressing tongs/pressing rings for all REMS radial presses (except for REMS Mini-Press ACC, REMS Mini-Press 22V ACC) and radial presses of other makes.

All pressing tongs marked by a * have another connection (**Patent EP 1 223 008**, **Patent US 6,739,172**) and also fit the manual radial press REMS Eco-Press. Thus simple, inexpensive stocking.

Pressing tongs/pressing rings for all common systems

Complete assortment of REMS pressing tongs/pressing rings for all common pressfitting systems (page 144–160). High-compression pressing tongs/pressing rings in forged and specially hardened steel. Pressing contours of REMS pressing tongs/pressing rings are system-specific and correspond to the respective pressfitting system. Thus perfect systemconformity, safe press jointing.

Design

Compact, robust, job site-proven. Small in size, slender design, drive unit only 4.7 kg. Works anywhere, free-hand, overhead, in confined areas. Ideal weight distribution for single handed operation. Ergonomically designed housing with recessed grip. Swivelling pressing tongs/adaptor tongs seat. Secure seating of pressing tongs by automatic locking. Also suitable for other suitable makes of pressing tongs/pressing rings.

Pressing operation by touch-control

For reliable service, operating and functional safety. A perfect joint is achieved when pressing tongs close completely. Acoustic signal after successful completion of pressing operation. The pressing tongs remain in a closed position until reset button is pushed and releases. This way, the perfect pressing joint (completely closed pressing jaws) can be observed.

Drive

Enormous thrust and pressing force for fast and perfect press jointing. Powerful electro-hydraulic drive with proven universal motor 450 W, robust planetary gear, eccentric reciprocating pump and compact high power hydraulic system. Safety tip switch.



Tested by electro-suisse >>>

German Quality Product



Supply format

REMS Power-Press Basic-Pack. Electro-hydraulic radial press with switch-off signal for producing pressing joints \varnothing 10–108 (110) mm, \varnothing $\frac{3}{8}$ –4". For driving REMS pressing tongs/pressing rings and other suitable makes of pressing tongs/pressing chains. Pressing tongs seat with automatic locking. Electro-hydraulic drive with proven universal motor 230 V or 110 V, 50–60 Hz, 450 W, robust planetary gear, eccentric reciprocating pump and compact high power hydraulic system. Safety tip switch. In sturdy steel case.

	Art.-No.	
	577011	

Other voltages on request.

Accessories

Description	Art.-No.
REMS Power-Press Drive Unit	577001
REMS pressing tongs/pressing rings see page 144–160.	
REMS cropping tongs for threaded rods see page 163.	
REMS cable shear for electric cable see page 163.	
Steel case with insert	570280



REMS Power-Press ACC

Electro-hydraulic radial press with automatic retraction

Universal, handy electric tool with automatic circuit control for producing pipe pressing joints for all common pressfitting systems.

Pipe pressing joints \varnothing 10–108 (110) mm
 \varnothing $\frac{3}{8}$ –4"

Complete range of REMS pressing tongs/pressing rings for all common pressfitting systems, see page 144–160.

REMS Power-Press ACC – universal up to \varnothing 110 mm. With automatic circuit control. Secure crimping in seconds. Automatic locking of pressing tongs.

System advantage

Only **one** type of pressing tongs/pressing rings for all REMS radial presses (except for REMS Mini-Press ACC, REMS Mini-Press 22V ACC) and radial presses of other makes.

All pressing tongs marked by a * have another connection (**Patent EP 1 223 008, Patent US 6,739,172**) and also fit the manual radial press REMS Eco-Press. Thus simple, inexpensive stocking.

Pressing tongs/pressing rings for all common systems

Complete assortment of REMS pressing tongs/pressing rings for all common pressfitting systems (page 144–160). High-compression pressing tongs/pressing rings in forged and specially hardened steel. Pressing contours of REMS pressing tongs/pressing rings are system-specific and correspond to the respective pressfitting system. Thus perfect systemconformity, safe press jointing.

Design

Compact, robust, job site-proven. Small in size, slender design, drive unit only 4.7 kg. Works anywhere, free-hand, overhead, in confined areas. Ideal weight distribution for single handed operation. Ergonomically designed housing with recessed grip. Swivelling pressing fit tongs/adaptor tongs seat. Secure seating of pressing tongs by automatic locking. Also suitable for other suitable makes of pressing tongs/pressing rings.

Pressing operation by touch-control with ACC

For reliable service, operating and functional safety. Automatic retraction after completion of pressing operation (automatic circuit control).

Drive

Enormous thrust and pressing force for fast and perfect press jointing. Powerful electro-hydraulic drive with proven universal motor 450 W, robust planetary gear, eccentric reciprocating pump and compact high power hydraulic system. Safety tip switch.



Tested by electrosuisse >>>

German Quality Product



Supply format

REMS Power-Press ACC Basic-Pack. Electro-hydraulic radial press with automatic retraction for producing pressing joints \varnothing 10–108 (110) mm, \varnothing $\frac{3}{8}$ –4". For driving REMS pressing tongs/pressing rings and other suitable makes of pressing tongs/pressing rings. Pressing tongs seat with automatic locking. Electro-hydraulic drive with proven universal motor 230 V or 110 V, 50–60 Hz, 450 W, robust planetary gear, eccentric reciprocating pump and compact high power hydraulic system. Safety tip switch. In sturdy steel case.

	Art.-No.
	577010

Other voltages on request.



Accessories

Description	Art.-No.
REMS Power-Press ACC Drive Unit	577000
REMS pressing tongs/pressing rings see page 144–160.	
REMS cropping tongs for threaded rods see page 163.	
REMS cable shear for electric cable see page 163.	
Steel case with insert	570280



REMS Akku-Press

Cordless radial press with switch-off signal

Universal, handy electric tool with switch-off signal for producing pipe pressing joints for all common pressfitting systems. For battery and corded operation.

Pipe pressing joints \varnothing 10–108 (110) mm / \varnothing $\frac{3}{8}$ –4

Complete range of REMS pressing tongs/pressing rings for all common pressfitting systems, see page 144–160.

REMS Akku-Press Li-Ion – universal up to \varnothing 110 mm. Secure crimping in seconds. Automatic locking of pressing tongs.

System advantage

Only **one** type of pressing tongs/pressing rings for all REMS radial presses (except for REMS Mini-Press ACC, REMS Mini-Press 22 V ACC) and radial presses of other makes.

All pressing tongs marked by a * have another connection (**Patent EP 1 223 008, Patent US 6,739,172**) and also fit the manual radial press REMS Eco-Press. Thus simple, inexpensive stocking.

Pressing tongs/pressing rings for all common systems

Complete assortment of REMS pressing tongs/pressing rings for all common pressfitting systems (page 144–160). High-compression pressing tongs/pressing rings in forged and specially hardened steel. Pressing contours of REMS pressing tongs/pressing rings are system-specific and correspond to the respective pressfitting system. Thus perfect system conformity, safe press jointing.

Design

Compact, handy, light. Drive unit with battery only 4.3 kg. Works anywhere, free-hand, overhead, in confined areas. Optimum weight distribution for single-hand operation. Ergonomically shaped housing with recessed grip. Integrated LED work light for illuminating the work place. Swivelling pressing tongs seat. Secure seating of pressing tongs/adaptor tongs by automatic locking. Also suitable for other suitable makes of pressing tongs/pressing rings. For battery and corded operation. Electronic charging status check with flat battery protection and charging status indicator with 2-coloured LED.

Pressing operation by touch-control

For reliable service, operating and functional safety. A perfect joint is achieved when pressing tongs close completely. Acoustic signal after successful completion of pressing operation. The pressing tongs remain in a closed position until reset button is pushed and releases. This way, the perfect pressing joint (completely closed pressing jaws) can be observed.

Drive

Enormous thrust and pressing force for fast and perfect press jointing. Powerful electro-hydraulic drive with powerful battery motor 14.4 V, 380 W output, robust planetary gear, eccentric reciprocating pump and compact high power hydraulic system. Safety tip switch.

Battery or mains operation

Li-Ion PLUS technology. Highly resistant Li-Ion 14.4 V battery with 3.0 Ah capacity, for long service life. Powerful and light. Li-Ion 14.4 V, 3.0 Ah battery for approx. 270 pressings Viega Profipress DN 15 per battery charge. Total discharge and overload protection with single cell monitoring. Temperature monitoring during the charging process. Operating temperature range -10 to $+60$ °C. No memory effect for maximum battery power. Rapid charger for short charging times. Li-Ion 230 V voltage supply for mains operation instead of Li-Ion battery 14.4 V, as accessory.

Supply format

REMS Akku-Press Li-Ion Basic-Pack. Cordless radial press with switch-off signal for producing pipe pressing joints \varnothing 10–108 (110) mm, \varnothing $\frac{3}{8}$ –4". For driving REMS pressing tongs/pressing rings and other suitable makes of pressing tongs/pressing rings. Swivelling pressing tongs seat with automatic locking. Electro-hydraulic drive with powerful battery motor 14.4 V, 380 W, robust planetary gear, eccentric reciprocating pump and compact high power hydraulic system. Safety tip switch. Integrated LED work light. Battery Li-Ion 14.4 V, 3.0 Ah, rapid charger Li-Ion/Ni-Cd 230 V or 110 V, 50–60 Hz, 65 W. In sturdy steel case.

	Art.-No.
	571013

Other voltages on request.

Accessories

Description	Art.-No.
REMS pressing tongs/pressing rings see page 144–160.	
REMS cropping tongs for threaded rods see page 163.	
REMS cable shear for electric cable see page 163.	
REMS Akku-Press Li-Ion drive unit, without battery	571003
Battery Li-Ion 14.4 V, 3.0 Ah	571555
Rapid charger Li-Ion/Ni-Cd 230 V, 50–60 Hz, 65 W	571560
Voltage supply Li-Ion 230 V	571565
Steel case with inlay	571290
REMS cordless LED lamp see page 95	175200



Tested by electro-suisse >>>

German Quality Product

REMS TECHNOLOGY
LI-ION PLUS

International
Design Award

LED



REMS Akku-Press ACC

Cordless radial press with automatic circuit control

Universal, handy electric tool with automatic circuit control for producing pipe pressing joints for all common pressfitting systems. For battery and corded operation.

Pipe pressing joints \varnothing 10–108 (110) mm / \varnothing $\frac{3}{8}$ –4

Complete range of REMS pressing tongs/pressing rings for all common pressfitting systems, see page 144–160.

REMS Akku-Press ACC Li-Ion – universal up to \varnothing 110 mm. With automatic circuit control. Secure crimping in seconds. Automatic locking of pressing tongs.

System advantage

Only one type of pressing tongs/pressing rings for all REMS radial presses (except for REMS Mini-Press ACC, REMS Mini-Press 22 V ACC) and radial presses of other makes.

All pressing tongs marked by a * have another connection (**Patent EP 1 223 008, Patent US 6,739,172**) and also fit the manual radial press REMS Eco-Press. Thus simple, inexpensive stocking.

Pressing tongs/pressing rings for all common systems

Complete assortment of REMS pressing tongs/pressing rings for all common pressfitting systems (page 144–160). High-compression pressing tongs/pressing rings in forged and specially hardened steel. Pressing contours of REMS pressing tongs/pressing rings are system-specific and correspond to the respective pressfitting system. Thus perfect system conformity, safe press jointing.

Design

Compact, handy, light. Drive unit with battery only 4.3 kg. Works anywhere, free-hand, overhead, in confined areas. Optimum weight distribution for single-hand operation. Ergonomically shaped housing with recessed grip. Integrated LED work light for illuminating the work place. Swivelling pressing tongs seat. Secure seating of pressing tongs/adaptor tongs by automatic locking. Also suitable for other suitable makes of pressing tongs/pressing rings. For battery and corded operation. Electronic charging status check with flat battery protection and charging status indicator with 2-coloured LED.

Pressing operation by touch-control with ACC

For reliable service, operating and functional safety. Automatic retraction after completion of pressing operation (automatic circuit control).

Drive

Enormous thrust and pressing force for fast and perfect press jointing. Powerful electro-hydraulic drive with powerful battery motor 14.4 V, 380 W output, robust planetary gear, eccentric reciprocating pump and compact high power hydraulic system. Safety tip switch.

Battery or mains operation

Li-Ion PLUS technology. Highly resistant Li-Ion 14.4 V battery with 3.0 Ah capacity, for long service life. Powerful and light. Li-Ion 14.4 V, 3.0 Ah battery for approx. 270 pressings Viega Profipress DN 15 per battery charge. Total discharge and overload protection with single cell monitoring. Temperature monitoring during the charging process. Operating temperature range -10 to $+60$ °C. No memory effect for maximum battery power. Rapid charger for short charging times. Li-Ion 230 V voltage supply for mains operation instead of Li-Ion battery 14.4 V, as accessory.

Supply format

REMS Akku-Press ACC Li-Ion Basic-Pack. Cordless radial press with automatic circuit control for producing pipe pressing joints \varnothing 10–108 (110) mm, \varnothing $\frac{3}{8}$ –4". For driving REMS pressing tongs/pressing rings and other suitable makes of pressing tongs/pressing rings. Swivelling pressing tongs seat with automatic locking. Electro-hydraulic drive with powerful battery motor 14.4 V, 380 W, robust planetary gear, eccentric reciprocating pump and compact high power hydraulic system. Safety tip switch. Integrated LED work light. Battery Li-Ion 14.4 V, 3.0 Ah, rapid charger Li-Ion/Ni-Cd 230 V or 110 V, 50–60 Hz, 65 W. In sturdy steel case.

Art.-No.	
5711014	

Other voltages on request.

Accessories

Description	Art.-No.
REMS pressing tongs/pressing rings see page 144–160.	
REMS cropping tongs for threaded rods see page 163.	
REMS cable shear for electric cable see page 163.	
REMS Akku-Press ACC Li-Ion drive unit, without battery	5711004
Battery Li-Ion 14.4 V, 3.0 Ah	571555
Rapid charger Li-Ion/Ni-Cd 230 V, 50–60 Hz, 65 W	571560
Voltage supply Li-Ion 230 V	571565
Steel case with inlay	571290
REMS cordless LED lamp see page 95	175200



Tested by electrosuisse >>>

German Quality Product



REMS pressing tongs REMS pressing rings

Accessories for REMS radial presses (except for REMS Mini-Press ACC, REMS Mini-Press 22 V ACC) and suitable radial presses of other makes

for all common pressfitting systems

German Quality Product



Patent EP 1 223 008
Patent US 6,739,172



REMS pressing tongs/REMS pressing rings

High-compression pressing tongs in forged and specially hardened steel. Pressing contours of REMS pressing tongs/pressing rings are system-specific and correspond with the respective pressfitting system. Thus perfect system-conformity, safe press jointing. Pressing jaws of pressing tongs/pressing rings manufactured on CNC production centres ensure high-precision machining of pressing contour. Hence far closer tolerances compared to as cast pressing contour.

Drive through all REMS radial presses (except for REMS Mini-Press ACC, REMS Mini-Press 22 V ACC) and suitable radial presses of other makes. All pressing tongs marked with * have an optional connection (Patent EP 1 223 008, Patent US 6,739,172) for manual drive through the radial press REMS Eco-Press. Read and follow the installation and assembly instructions of the system provider/manufacturer.

Select pressing tongs/pressing rings yourself!

Search for the required pressfitting system in the opposite table and select the correct pressing tongs size/pressing rings size. Please note that pressfitting systems for gas installation may only be pressed with the pressing tongs/pressing rings which are highlighted in yellow in the table. Intermediate tongs (page 160) are necessary for driving the REMS pressing rings (PR).

Traceability according to EN 1775:2007

REMS pressing tongs/pressing rings with pressing contour F, M, V, SA, B, RN and UP have worked a specific marking into the pressing contour which leaves a lasting impression on the pressed fitting after the pressing process. This enables the user to check again whether the most suitable pressing tongs or the suitable pressing ring have been used to make the pressfit connection even after the pressing process.

With this traceability REMS fulfils the recommendations of the European standard EN 1775:2007 for the installation of pressfitting systems for gas.



Example REMS pressing tongs M: "M" imprint on pressed fitting for traceability according to EN 1775:2007

Hold-Harmless and Indemnification Agreement

See page 162.

Confirmation of suitability

See page 161.



Pressing contours

ACz		
B		
F		
G		
H		
HA		
HE		
K		
KI		
M		
MT		
RFz		
RN		
SA		
TH		
U		
UP		
US		
V		
VAU		
VIC		
VP		
VRX		
VX		
VUS		

REMS pressing tongs REMS pressing rings

Accessories for REMS radial presses (except for REMS Mini-Press ACC, REMS Mini-Press 22 V ACC) and suitable radial presses of other makes

System	Pressing contour	Art.-No.	System	Pressing contour	Art.-No.	System	Pressing contour	Art.-No.	
AC-FIX PRESS (Global Piping Systems)	H 12*	570300	AIRBEL	M 15	570110	ASTM F 1807	US 3/4**	571450	
	H 16*	570320	SERTINOX	M 18	570120	(Fittings with	US 1/2**	571455	
	H 20*	570350		M 22	570130	Copper Crimp	US 3/4**	571460	
	H 25*	570360		M 28	570140	Ring for PEX	US 1**	571465	
	H 32	570380		M 35	570150	tubing)	US 1 1/4"	571470	
	RFz 12*	571320		M 42 (PR-3S) ³⁾	572706		US 1 1/2"	571475	
	RFz 16*	571325		M 54 (PR-3S) ³⁾	572708	Bampi BALPEX	US 2"	571477	
	RFz 20*	571330		M 15 45° (PR-2B) ³⁾	574522	(serie MP)	TH 14*	570455	
	RFz 25	571335		M 18 45° (PR-2B) ³⁾	574524		TH 16*	570460	
	RFz 32	571340		M 22 45° (PR-2B) ³⁾	574526		TH 18*	570465	
	U 16*	570765		M 28 45° (PR-2B) ³⁾	574528		TH 20*	570470	
	U 20*	570775	M 35 45° (PR-2B) ³⁾	574530		TH 26*	570475		
	U 25*	570780	ALB	TH 16*	570460	TH 32	570480		
	U 32	570785	Sistema Multicapa	TH 18*	570465	TH 40	570485		
	VX 16*	571635		TH 20*	570470	TH 50 (S)	572400		
	VX 20*	571640		TH 26*	570475	TH 63 (S)	572405		
	AC-FIX PRESS-MULTI (Global Piping Systems)	H 16*	570320		TH 32	570480	Bampi BALPEX	TH 16*	570460
	H 18*	570340		TH 40	570485		TH 20*	570470	
	H 20*	570350		TH 50 (S)	572400		TH 26*	570475	
H 25*	570360		TH 63 (S)	572405	BARBI	H 12*	570300		
H 32	570380		H 16*	570320	EASYPRESS	H 16*	570320		
RFz 16*	571325		H 18*	570340	(Industrial Blansol)	H 20*	570350		
RFz 20*	571330		H 20*	570350		H 25*	570360		
RFz 25	571335		H 26*	570370		H 32	570380		
RFz 32	571340		H 32	570380		H 40 (4G)	570390		
U 16*	570765		H 40 (4G)	570390		RFz 12*	571320		
U 18*	570770		U 16*	570765		RFz 16*	571325		
U 20*	570775		U 18*	570770		RFz 20*	571330		
U 25*	570780		U 20*	570775		RFz 25	571335		
U 32	570785		C 26*	570750		RFz 32	571340		
ACOME MT	ACz 12*	572642	U 32	570785		U 16*	570765		
	ACz 16*	572644	U 40	570790		U 20*	570775		
	ACz 20*	572646	APE Serie AP	B 16*	570850	U 25*	570780		
	ACz 25	572648		B 20*	570860	U 32	570785		
AHSELL A-press elförzinkad	M 12	570100		B 26	570870	U 40	570790		
	M 15	570110		B 32	570880	U 50	570795		
	M 18	570120		H 16*	570320	U 63 (PR-3B) ³⁾	572837		
	M 22	570130		H 20*	570350	U 63 (S)	572365		
	M 28	570140		H 26*	570370	U 75 (PR-3B) ³⁾	572828		
	M 35	570150		H 32	570380	BARBI	H 14*	570310	
	M 42 (PR-3S) ³⁾	572706		TH 16*	570460	MULTIPEX	H 16*	570320	
	M 54 (PR-3S) ³⁾	572708		TH 18*	570465	(Industrial Blansol)	H 18*	570340	
	M 12 45° (PR-2B) ³⁾	574520		TH 20*	570470		H 20*	570350	
	M 15 45° (PR-2B) ³⁾	574522		TH 26*	570475		H 25*	570360	
	M 18 45° (PR-2B) ³⁾	574524		TH 32	570480		H 26*	570370	
	M 22 45° (PR-2B) ³⁾	574526		U 16*	570765		H 32	570380	
	M 28 45° (PR-2B) ³⁾	574528		U 20*	570775		H 40 (4G)	570390	
	M 35 45° (PR-2B) ³⁾	574530		U 40	570790		RFz 16*	571325	
				U 50	570795		RFz 18*	571327	
AHSELL A-press koppar	V 12	570107		U 63 (PR-3B) ³⁾	572837		RFz 20*	571330	
	V 15	570115		U 63 (S)	572365		RFz 25	571335	
	V 18	570125	APE Serie AP	TH 16*	570460		RFz 32	571340	
	V 22	570135	Gas	TH 20*	570470		TH 16*	570460	
	V 28	570145		TH 26*	570475		TH 18*	570465	
	V 35	570155		TH 32	570480		TH 20*	570470	
	V 42	570165		AQUATECHNIK	B 16*	570850	TH 25*	570495	
	V 54	570175	Universal	B 20*	570860		TH 26*	570475	
	V 12 45° (PR-2B) ³⁾	574502		B 26	570870		TH 32	570480	
	V 15 45° (PR-2B) ³⁾	574504		B 32	570880		TH 40	570485	
	V 18 45° (PR-2B) ³⁾	574506		F 16*	570717		TH 50 (S)	572400	
	V 22 45° (PR-2B) ³⁾	574508		F 20*	570727		TH 63 (S)	572405	
	V 28 45° (PR-2B) ³⁾	574510		F 26*	570730		TH 75 (PR-3B) ³⁾	572829	
	V 35 45° (PR-2B) ³⁾	574512		F 32	570735		U 16*	570765	
AHSELL A-press rostfritt	M 15	570110		H 16*	570320		U 18*	570770	
	M 18	570120		H 20*	570350		U 20*	570775	
	M 22	570130		H 26*	570370		U 25*	570780	
	M 28	570140		H 32	570380		U 32	570785	
	M 35	570150		TH 16*	570460		U 40	570790	
	M 42 (PR-3S) ³⁾	572706		TH 20*	570470		U 50	570795	
	M 54 (PR-3S) ³⁾	572708		TH 26*	570475		U 63 (PR-3B) ³⁾	572837	
	M 15 45° (PR-2B) ³⁾	574522		TH 32	570480		U 63 (S)	572365	
	M 18 45° (PR-2B) ³⁾	574524		U 16*	570765		U 75 (PR-3B) ³⁾	572828	
	M 22 45° (PR-2B) ³⁾	574526		U 20*	570775		BEGETUBE/ IVAR	B 14*	570845
	M 28 45° (PR-2B) ³⁾	574528		C 26*	570750		B 16*	570850	
	M 35 45° (PR-2B) ³⁾	574530		U 32	570785		B 18*	570855	
AIRBEL PRESSCLIM	M 15	570110	ASCHL NIR	M 15	570110		B 20*	570860	
	M 18	570120		M 18	570120		B 26	570870	
	M 22	570130		M 22	570130		B 32	570880	
	M 28	570140		M 28	570140		F 40	570742	
	M 35	570150		M 35	570150		F 50	570745	
	M 42 (PR-3S) ³⁾	572706		M 42 (PR-3S) ³⁾	572706		F 63 (S)	572385	
	M 54 (PR-3S) ³⁾	572708		M 54 (PR-3S) ³⁾	572708		F 75 (PR-3B) ³⁾	572830	
	M 15 45° (PR-2B) ³⁾	574522		M 15 45° (PR-2B) ³⁾	574522		BRASELI	RFz 16*	571325
	M 18 45° (PR-2B) ³⁾	574524		M 18 45° (PR-2B) ³⁾	574524		Pressfitting PE-X	RFz 20*	571330
	M 22 45° (PR-2B) ³⁾	574526		M 22 45° (PR-2B) ³⁾	574526			RFz 25	571335
	M 28 45° (PR-2B) ³⁾	574528		M 28 45° (PR-2B) ³⁾	574528			RFz 32	571340
	M 35 45° (PR-2B) ³⁾	574530		M 35 45° (PR-2B) ³⁾	574530				

Pressfitting systems for gas installations must only be pressed with pressing tongs/pressing rings which are highlighted in yellow. Observe the national regulations.

* These pressing tongs also fit the manual radial press REMS Eco-Press. Observe the national regulations.

1) Only pressing tongs from designation "108" (1st quarter of 2008), "208" (2nd quarter of 2008) etc. can be used. The designation is stamped on every pressing jaw.

2) For this pressfitting system producing a pressing joint with manual radial presses is not permitted.

3) Adapter tongs are required for driving pressing rings (PR), see page 160.

4) Press fittings made of red bronze (ProPress XL) must be pressed with pressing rings with press contour VUSR, copper fittings (ProPress XL-C) and stainless steel fittings (ProPress XL-S) with pressing rings with press contour VUSF.

5) For taking suitable pressing inserts.

6) Press fittings made of red bronze (Sanpress XL) must be pressed with pressing rings with press contour VR, copper fittings (Profipress XL, Profipress G XL), carbon steel (Prestabo XL) and stainless steel fittings (Sanpress Inox XL, Sanpress Inox G XL) with pressing rings with press contour VF.

7) Driven by REMS Power-Press XL.

The suitability of REMS pressing tools for pressfitting systems: Date 09.10.2015. For the updated situation regarding suitability status check our website: www.rems.de → Downloads → Product catalogues, brochures → REMS Catalogue.

Pressing tongs/pressing rings for additional pressfitting systems on request.

REMS pressing tongs REMS pressing rings

Accessories for REMS radial presses (except for REMS Mini-Press ACC,
REMS Mini-Press 22 V ACC) and suitable radial presses of other makes

System	Pressing contour	Art.-No.	System	Pressing contour	Art.-No.	System	Pressing contour	Art.-No.	
BRASELLI Pressfitting Multicapa	U 16*	570765	COMAP SudoPress Copper	V 12	570107	COMISA Press System	TH 14*	570455	
	U 18*	570770		V 14	570112		TH 16*	570460	
	U 20*	570775		V 15	570115		TH 18*	570465	
	U 25*	570780		V 16	570117		TH 20*	570470	
	U 32	570785		V 18	570125		TH 25*	570495	
	U 40	570790		V 22	570135		TH 26*	570475	
Brass Form Press Form Pex	U 50	570795	V 28	570145	TH 32	570480			
	H 16*	570320	V 35	570155	TH 40	570485			
	H 18*	570340	V 42	570165	TH 50 (S)	572400			
	H 20*	570350	V 54	570175	TH 63 (S)	572405			
	TH 16*	570460	COMAP SudoPress Copper Gas	V 12	570107	H 14*	570310		
	TH 18*	570465		V 14	570112	H 16*	570320		
	TH 20*	570470		V 15	570115	H 18*	570340		
	U 16*	570765		V 16	570117	H 20*	570350		
	U 18*	570770		V 18	570125	H 26*	570370		
	U 20*	570775		V 22	570135	H 32	570380		
Brass Form Press Form Pex-Al-Pex	H 16*	570320	V 28	570145	B 14*	570845			
	H 18*	570340	V 35	570155	B 16*	570850			
	H 20*	570350	V 42	570165	B 18*	570855			
	TH 16*	570460	V 54	570175	B 20*	570860			
	TH 18*	570465	COMAP SudoPress Copper Solar	V 14	570112	B 26	570870		
	TH 20*	570470		V 15	570115	B 32	570880		
U 16*	570765	V 16		570117	COMISA Press System Gas	TH 16*	570460		
U 18*	570770	V 18		570125		TH 20*	570470		
U 20*	570775	V 22		570135		TH 26*	570475		
Brass & Fittings Pressman Multicapa	RFz 16*	571325		V 28		570145	TH 32	570480	
	RFz 18*	571327	V 35	570155		CONEL CONNECT MULTI	F 16*	570717	
	ACz 20*	572646	V 42	570165			F 20*	570727	
	RFz 25	571335	V 54	570175	F 26*		570730		
	RFz 32	571340	COMAP SudoPress Stainless	V 15	570115		F 32	570735	
	Brass & Fittings Retipress	RFz 16*		571325	V 18		570125	H 16*	570320
RFz 18*		571327		V 22	570135		H 20*	570350	
ACz 20*		572646		V 28	570145	H 26*	570370		
RFz 25		571335		V 35	570155	H 32	570380		
RFz 32		571340		V 42	570165	TH 16*	570460		
BRASSTECH MULTIthermoSAN Brasspress		RFz 16*	571325	V 54	570175	TH 20*	570470		
	TH 16*	570460	Comap PexPress	RFz 12*	571320	TH 26*	570475		
	TH 18*	570465		RFz 16*	571325	TH 32	570480		
	TH 20*	570470		RFz 20*	571330	U 16*	570765		
	TH 26*	570475		RFz 25	571335	U 20*	570775		
	TH 32	570480		Comap SkinPress	TH 14*	570455	U 25*	570780	
	TH 40	570485			TH 16*	570460	U 32	570785	
	TH 50 (S)	572400	TH 18*		570465	VP 16*	570910		
	TH 63 (S)	572405	TH 20*		570470	VP 20*	570915		
	U 16*	570765	THL 32		570487	VP 32	570925		
	U 18*	570770	TH 40		570485	DIWAsystems	TH 14*	570455	
	U 20*	570775	TH 50 (S)	572400	TH 16*		570460		
	Business Key MT-PRESS (inox)	M 15	570110	TH 63 (S)	572405		TH 20*	570470	
		M 18	570120	Comap SkinPress Gas	TH 16*		570460	TH 26*	570475
M 22		570130	TH 20*		570470		TH 32	570480	
M 28		570140	TH 26*		570475		TH 40	570485	
M 35		570150	THL 32		570487	TH 50 (S)	572400		
M 42 (4G)		570160	COMAP Xpress Carbon		TH 16*	570460	TH 63 (S)	572405	
M 54 (4G)		570170			TH 20*	570470	DUOFIL MKSYSYSTEM	U 16*	570765
M 42 (PR-3S) ³⁾		572706		THL 32	570487	U 18*		570770	
M 54 (PR-3S) ³⁾		572708		M 12	570100	U 20*		570775	
M 15 45° (PR-2B) ³⁾		574522		M 15	570110	U 25*		570780	
M 18 45° (PR-2B) ³⁾		574524		M 18 ¹⁾	570120	U 32		570785	
M 22 45° (PR-2B) ³⁾		574526	M 22	570130	DW Verbundrohr multitubo systems	U 16*		570765	
M 28 45° (PR-2B) ³⁾		574528	M 28 ¹⁾	570140		U 18*	570770		
M 35 45° (PR-2B) ³⁾		574530	M 35	570150		U 20*	570775		
Cello Products >B< Press	VUS ½" (OD 15,9 mm)	571770	M 42 (4G)	570160		U 25*	570780		
	VUS ¾" (OD 22,2 mm)	571775	M 54 (4G)	570170		U 32	570785		
	VUS 1" (OD 28,6 mm)	571780	M 42 (PR-3S) ³⁾	572706		U 40	570790		
	VUS 1¼" (OD 34,9 mm)	571785	M 54 (PR-3S) ³⁾	572708	U 50	570795			
	VUS 1½" (OD 41,3 mm)	571790	M 12 45° (PR-2B) ³⁾	574520	U 63 (PR-3B) ³⁾	572837			
	VUS 2" (OD 54,0 mm)	571795	M 15 45° (PR-2B) ³⁾	574522	U 63 (S)	572365			
	CHIALI CHIALIPEX	TH 16*	570460	M 18 45° (PR-2B) ³⁾	574524	U 75 (PR-3B) ³⁾	572828		
		TH 20*	570470	M 22 45° (PR-2B) ³⁾	574526	EBRILLE Isomonflex	U 16*	570765	
		TH 26*	570475	M 28 45° (PR-2B) ³⁾	574528		U 18*	570770	
		TH 32	570480	M 35 45° (PR-2B) ³⁾	574530		U 20*	570775	
		TH 40	570485	COMAP Xpress Copper	M 12		570100	U 25*	570780
		TH 50 (S)	572400		M 15		570110	H 26*	570370
		TH 63 (S)	572405		M 18 ¹⁾		570120	TH 26*	570475
		Climatek Clima Therm	TH 14*		570455	M 22	570130	U 32	570785
TH 16*			570460		M 28 ¹⁾	570140	U 40	570790	
TH 18*			570465		M 35	570150	U 50	570795	
TH 20*	570470		M 42 (PR-3S) ³⁾	572706	U 63 (PR-3B) ³⁾	572837			
TH 26*	570475		M 54 (PR-3S) ³⁾	572708	U 63 (S)	572365			
TH 32	570480		M 12 45° (PR-2B) ³⁾	574520	U 75 (PR-3B) ³⁾	572828			
Climatrix Climatrix Rhinopex	H 40 A (4G)	570695	M 15 45° (PR-2B) ³⁾	574522	EBRILLE Monflex	U 16*	570765		
	H 16*	570320	M 18 45° (PR-2B) ³⁾	574524		U 18*	570770		
	H 20*	570350	M 22 45° (PR-2B) ³⁾	574526		U 20*	570775		
	U 16*	570765	M 28 45° (PR-2B) ³⁾	574528		U 25*	570780		
	U 20*	570775	M 35 45° (PR-2B) ³⁾	574530		H 26*	570370		
	TH 14*	570455	COMAP Xpress Stainless	M 12		570100	TH 26*	570475	
	TH 16*	570460		M 15	570110	U 32	570785		
	TH 18*	570465		M 18 ¹⁾	570120	EFFEBI PRESSTIGE	U 14*	570760	
	TH 20*	570470		M 22	570130		U 16*	570765	
	TH 26*	570475		M 28 ¹⁾	570140		U 18*	570770	
TH 32	570480	M 35		570150	U 20*		570775		
ClouSet	TH 16*	570460	M 42 (PR-3S) ³⁾	572706	U 25*		570780		
	TH 18*	570465	M 54 (PR-3S) ³⁾	572708	H 26*		570370		
	TH 20*	570470	M 12 45° (PR-2B) ³⁾	574520	TH 26*	570475			
	COMAP SudoPress Carbon	V 12	570107	M 15 45° (PR-2B) ³⁾	574522	U 32	570785		
		V 15	570115	M 18 45° (PR-2B) ³⁾	574524	U 40	570790		
		V 18	570125	M 22 45° (PR-2B) ³⁾	574526	U 50	570795		
		V 22	570135	M 28 45° (PR-2B) ³⁾	574528	U 63 (PR-3B) ³⁾	572837		
		V 28	570145	M 35 45° (PR-2B) ³⁾	574530	U 63 (S)	572365		
		V 32	570155	COMAP Xpress Copper Gas	M 12	570100	U 75 (PR-3B) ³⁾	572828	
		V 35	570165		M 15	570110	EFFEBI PRESSTIGE	M 15	570110
V 42		570175	M 18 ¹⁾		570120	M 18		570120	
COMAP SudoPress Copper		V 12	570107		M 22	570130		M 22	570130
		V 14	570112		M 28 ¹⁾	570140		M 28	570140
	V 15	570115	M 35		570150	M 35		570150	
	V 16	570117	COMAP Xpress Stainless	M 42 (PR-3S) ³⁾	572706	M 15 45° (PR-2B) ³⁾		574522	
	V 18	570125		M 15	570110	M 18 45° (PR-2B) ³⁾	574524		
	V 22	570135		M 18 ¹⁾	570120	M 22 45° (PR-2B) ³⁾	574526		
	V 28	570145		M 22	570130	M 28 45° (PR-2B) ³⁾	574528		
	V 35	570155		M 28 ¹⁾	570140	M 35 45° (PR-2B) ³⁾	574530		
	V 42	570165		M 35	570150	V 15	570115		
	V 54	570175	M 42 (4G)	570160	V 18	570125			
COMISA Press System	TH 14*	570455	M 54 (4G)	570170	V 22	570135			
	TH 16*	570460	M 42 (PR-3S) ³⁾	572706	V 28	570145			
	TH 18*	570465	M 54 (PR-3S) ³⁾	572708	V 35	570155			
	TH 20*	570470	M 15 45° (PR-2B) ³⁾	574522	V 42	570165			
	TH 25*	570495	M 18 45° (PR-2B) ³⁾	574524	V 54	570175			
	TH 26*	570475	M 22 45° (PR-2B) ³⁾	574526	COMISA Press System Gas	TH 16*	570460		
	TH 32	570480	M 28 45° (PR-2B) ³⁾	574528		TH 20*	570470		
	TH 40	570485	M 35 45° (PR-2B) ³⁾	574530		TH 26*	570475		
	TH 50 (S)	572400	COMAP Xpress Carbon	M 12		570100	TH 32	570480	
	TH 63 (S)	572405		M 15		570110	CONEL CONNECT MULTI	F 16*	570717
	H 14*	570310		M 18 ¹⁾		570120		F 20*	570727
	H 16*	570320		M 22	570130	F 26*		570730	
	H 18*	570340		M 28 ¹⁾	570140	F 32		570735	
	H 20*	570350		M 35	570150	H 16*		570320	
H 26*	570370	M 42 (PR-3S) ³⁾	572706	H 20*	570350				
H 32	570380	M 54 (PR-3S) ³⁾	572708	H 26*	570370				
B 14*	570845	COMAP Xpress Stainless	M 12 45° (PR-2B) ³⁾	574520	H 32	570380			
B 16*	570850		M 15 45° (PR-2B) ³⁾	574522	TH 16*	570460			
B 18*	570855		M 18 45° (PR-2B) ³⁾	574524	TH 20*	570470			
B 20*	570860		M 22 45° (PR-2B) ³⁾	574526	TH 26*	570475			
B 26	570870		M 28 45° (PR-2B) ³⁾	574528	TH 32	570480			
B 32	570880		M 35 45° (PR-2B) ³⁾	574530	U 16*	570765			
COMISA Press System Gas	TH 16*	570460	COMAP Xpress Carbon	M 12	570100	U 20*	570775		
	TH 20*	570470		M 15	570110	U 25*	570780		
	TH 26*	570475		M 18 ¹⁾	570120	U 32	570785		
	TH 32	570480		M 22	570130	DW Verbundrohr multitubo systems	U 16*	570765	
	CONEL CONNECT MULTI	F 16*		570717	M 28 ¹⁾		570140	U 18*	570770
		F 20*		570727	M 35		570150	U 20*	570775
F 26*		570730	M 42 (PR-3S) ³⁾	572706	U 25*		570780		
F 32		570735	M 54 (PR-3S) ³⁾	572708	U 32		570785		
H 16*		570320	COMAP Xpress Stainless	M 12 45° (PR-2B) ³⁾	574520		U 40	570790	
H 20*		570350		M 15 45° (PR-2B) ³⁾	574522	U 50	570795		
H 26*	570370	M 18 45° (PR-2B) ³⁾		574524	U 63 (PR-3B) ³⁾	572837			
H 32	570380	M 22 45° (PR-2B) ³⁾		574526	U 63 (S)	572365			
TH 16*	570460	M 28 45° (PR-2B) ³⁾		574528	U 75 (PR-3B) ³⁾	572828			
TH 20*	570470	M 35 45° (PR-2B) ³⁾		574530	EFFEBI PRESSTIGE	M 15	570110		
TH 26*	570475	COMAP Xpress Copper Gas	M 12	570100		M 18	570120		
TH 32	570480		M 15	570110		M 22	570130		
U 16*	570765		M 18 ¹⁾	570120		M 28	570140		
U 18*	570770		M 22	570130		M 35	570150		
U 20*	570775		M 28 ¹⁾	570140		M 15 45° (PR-2B) ³⁾	574522		
COMISA Press System	TH 14*		570455	M 35	570150	M 18 45° (PR-2B) ³⁾	574524		
	TH 16*	570460	M 42 (PR-3S) ³⁾	572706	M 22 45° (PR-2B) ³⁾	574526			
	TH 18*	570465	M 54 (PR-3S) ³⁾	572708	M 28 45° (PR-2B) ³⁾	574528			
	TH 20*	570470	COMAP Xpress Stainless	M 12					

REMS pressing tongs REMS pressing rings

Accessories for REMS radial presses (except for REMS Mini-Press ACC, REMS Mini-Press 22 V ACC) and suitable radial presses of other makes

System	Pressing contour	Art.-No.	System	Pressing contour	Art.-No.	System	Pressing contour	Art.-No.		
EFFEBI TOF MULTIPINZA	TH 16*	570460	EURACCORDI	M 15	570110	F.B.Q. BARONIO BQ press	V 12	570107		
	TH 18*	570465		SYPRESS	M 18		570120	V 14	570112	
	TH 20*	570470		CARBON STEEL	M 22		570130	V 15	570115	
	TH 26*	570475		PRESS FITTINGS	M 28		570140	V 16	570117	
	TH 32	570480		M 35	570150		V 18	570125		
	TH 40	570485		M 42 (PR-3S) ³⁾	572706		V 22	570135		
	TH 50 (S)	572400		M 54 (PR-3S) ³⁾	572708		V 28	570145		
	TH 63 (S)	572405		M 15 45° (PR-2B) ³⁾	574522		V 35	570155		
	F 16*	570715		M 18 45° (PR-2B) ³⁾	574524		V 42	570165		
	F 18*	570720		M 22 45° (PR-2B) ³⁾	574526		V 54	570175		
	F 20*	570725		M 28 45° (PR-2B) ³⁾	574528		V 12 45° (PR-2B) ³⁾	574502		
	F 26*	570730		M 35 45° (PR-2B) ³⁾	574530		V 14 45° (PR-2B) ³⁾	574532		
	F 32	570735		EUROTUBI	M 12		570100	V 15 45° (PR-2B) ³⁾	574504	
	F 40	570742		Europa C-STAHl	M 15		570110	V 16 45° (PR-2B) ³⁾	574534	
	F 50	570745		PRESSFITTING	M 18		570120	V 18 45° (PR-2B) ³⁾	574506	
	F 63 (S)	572385		SISTEM ¹⁾	M 22		570130	V 22 45° (PR-2B) ³⁾	574508	
	H 16*	570320		M 28	570140		V 28 45° (PR-2B) ³⁾	574510		
	H 18*	570340		M 35	570150		V 35 45° (PR-2B) ³⁾	574512		
	H 20*	570350		M 42 (PR-3S) ³⁾	572706		F.B.Q. BARONIO	V 15	570115	
	H 26*	570370	M 54 (PR-3S) ³⁾	572708	BQ press	V 18	570125			
	H 32	570380	M 12 45° (PR-2B) ³⁾	574520	carbon steel	V 22	570135			
	H 40 (4G)	570390	M 15 45° (PR-2B) ³⁾	574522	V 28	570145				
	U 16*	570765	M 18 45° (PR-2B) ³⁾	574524	V 35	570155				
	U 18*	570770	M 22 45° (PR-2B) ³⁾	574526	V 42	570165				
	U 20*	570775	M 28 45° (PR-2B) ³⁾	574528	V 54	570175				
	U 25*	570780	M 35 45° (PR-2B) ³⁾	574530	V 15 45° (PR-2B) ³⁾	574506				
	C 26*	570750	EUROTUBI	M 15	570110	V 18 45° (PR-2B) ³⁾	574506			
	U 32	570785	Europa INOX	M 18	570120	V 22 45° (PR-2B) ³⁾	574508			
	U 40	570790	PRESSFITTING	M 22	570130	V 28 45° (PR-2B) ³⁾	574510			
	U 50	570795	SISTEM ¹⁾	M 28	570140	V 35 45° (PR-2B) ³⁾	574512			
	U 63 (PR-3B) ³⁾	572837	M 35	570150	F.B.Q. BARONIO	V 15	570115			
	U 63 (S)	572365	M 42 (PR-3S) ³⁾	572706	BQ press gas	V 18	570125			
	B 16*	570850	M 54 (PR-3S) ³⁾	572708	V 22	570135				
	B 18*	570855	M 15 45° (PR-2B) ³⁾	574522	V 28	570145				
	B 20*	570860	M 18 45° (PR-2B) ³⁾	574524	V 35	570155				
	B 26	570870	M 22 45° (PR-2B) ³⁾	574526	V 42	570165				
	B 32	570880	M 28 45° (PR-2B) ³⁾	574528	V 54	570175				
	Eikhart APOLLOXPRESS Fittings Copper and Low-Lead Brass	VUS 1/2" (OD 15,9 mm)	571770	M 35 45° (PR-2B) ³⁾	574530	V 15 45° (PR-2B) ³⁾	574504			
		VUS 3/4" (OD 22,2 mm)	571775	Evans	VAU 15 (1/2")	572687	V 18 45° (PR-2B) ³⁾	574506		
VUS 1" (OD 28,6 mm)		571780	Components	VAU 20 (3/4")	572689	V 22 45° (PR-2B) ³⁾	574508			
VUS 1 1/4" (OD 34,9 mm)		571785	Presslok	VAU 25 (1")	572691	V 28 45° (PR-2B) ³⁾	574510			
VUS 1 1/2" (OD 41,3 mm)		571790	ECI 1 1/2"	571932	ECI 2" (4G)	571934	V 35 45° (PR-2B) ³⁾	574512		
VUS 2" (OD 54,0 mm)		571795	ECI 2 1/2" (PR-3S) ³⁾	579104	ECI 3" (PR-3S) ³⁾	579105	Fercofloor	RFz 16*	571325	
VUSF 2 1/2" (PR-3B) ³⁾		572819	ECI 3" (PR-3S) ³⁾	579105	ECI 4" (XL PR-3S) ³⁾	579106	DUO Press	RFz 20*	571330	
EUROTUBI		M 15	570110	FAR Rubinetterie	TH 14*	570455	FERCO PEX	RFz 25	571335	
Europa C-STAHl	M 15	570110	PRESSFAR	TH 16*	570460	RFz 32	571340			
PRESSFITTING	M 18	570120	TH 17*	570462	TH 18*	570465	Fercofloor	RFz 16*	571325	
SISTEM ¹⁾	M 22	570130	TH 20*	570470	TH 25*	570495	DUO Press	RFz 20*	571330	
M 28	570140	TH 26*	570475	TH 32	570480	U 16*	570765	MULTIFER	RFz 25	571335
M 35	570150	TH 32	570480	TH 40	570485	U 18*	570770	RFz 32	571340	
M 42 (PR-3S) ³⁾	572706	TH 50 (S)	572400	TH 50 (S)	572400	U 20*	570775	U 25*	570780	
M 54 (PR-3S) ³⁾	572708	TH 63 (S)	572405	H 14*	570310	U 32	570785	FILTUBE	FTB 15	571432
M 15 45° (PR-2B) ³⁾	574522	H 16*	570320	H 16*	570320	Filpress	FTB 18	571434	FTB 18	571434
M 18 45° (PR-2B) ³⁾	574524	H 18*	570340	H 18*	570340	FTB 22	571436	FTB 22	571436	
M 22 45° (PR-2B) ³⁾	574526	H 20*	570350	H 20*	570350	FTB 28	571438	FTB 28	571438	
M 28 45° (PR-2B) ³⁾	574528	H 26*	570370	H 26*	570370	FTB 35	571440	FTB 35	571440	
M 35 45° (PR-2B) ³⁾	574530	H 32	570380	H 32	570380	M 42 (4G)	570160	M 42 (4G)	570170	
		H 40 (4G)	570390	H 40 (4G)	570390	M 54 (4G)	570170	M 54 (4G)	570170	
		U 14*	570760	U 14*	570760	M 42 (PR-3S) ³⁾	572706	M 42 (PR-3S) ³⁾	572706	
		U 16*	570765	U 16*	570765	M 54 (PR-3S) ³⁾	572708	M 54 (PR-3S) ³⁾	572708	
		U 18*	570770	U 18*	570770	M 15 45° (PR-2B) ³⁾	574522	M 15 45° (PR-2B) ³⁾	574522	
		U 20*	570775	U 20*	570775	M 18 45° (PR-2B) ³⁾	574524	M 18 45° (PR-2B) ³⁾	574524	
		U 25*	570780	U 25*	570780	M 22 45° (PR-2B) ³⁾	574526	M 22 45° (PR-2B) ³⁾	574526	
		U 32	570785	U 32	570785	M 28 45° (PR-2B) ³⁾	574528	M 28 45° (PR-2B) ³⁾	574528	
		U 40	570790	U 40	570790	M 35 45° (PR-2B) ³⁾	574530	M 35 45° (PR-2B) ³⁾	574530	
		U 50	570795	U 50	570795					
		U 63 (PR-3B) ³⁾	572837	U 63 (PR-3B) ³⁾	572837					
		U 63 (S)	572365	U 63 (S)	572365					

Pressfitting systems for gas installations must only be pressed with pressing tongs/pressing rings which are highlighted in yellow. Observe the national regulations.

* These pressing tongs also fit the manual radial press REMS Eco-Press. Observe the national regulations.

- Only pressing tongs from designation "108" (1st quarter of 2008), "208" (2nd quarter of 2008) etc. can be used. The designation is stamped on every pressing jaw.
- For this pressfitting system producing a pressing joint with manual radial presses is not permitted.
- Adapter tongs are required for driving pressing rings (PR), see page 160.
- Press fittings made of red bronze (ProPress XL) must be pressed with pressing rings with press contour VUSR, copper fittings (ProPress XL-C) and stainless steel fittings (ProPress XL-S) with pressing rings with press contour VUSF.
- For taking suitable pressing inserts.
- Press fittings made of red bronze (Sanpress XL) must be pressed with pressing rings with press contour VR, copper fittings (Profipress XL, Profipress G XL), carbon steel (Prestabo XL) and stainless steel fittings (Sanpress Inox XL, Sanpress Inox G XL) with pressing rings with press contour VF.
- Driven by REMS Power-Press XL.

The suitability of REMS pressing tools for pressfitting systems: Date 09.10.2015. For the updated situation regarding suitability status check our website: www.rems.de → Downloads → Product catalogues, brochures → REMS Catalogue.

Pressing tongs/pressing rings for additional pressfitting systems on request.

REMS pressing tongs REMS pressing rings

Accessories for REMS radial presses (except for REMS Mini-Press ACC, REMS Mini-Press 22 V ACC) and suitable radial presses of other makes

System	Pressing contour	Art.-No.	
FILTUBE Instalpress Copper	M 15	570110	
	M 18	570120	
	M 22	570130	
	M 28	570140	
	M 35	570150	
	M 42 (4G)	570160	
	M 54 (4G)	570170	
	M 42 (PR-3S) ³⁾	572706	
	M 54 (PR-3S) ³⁾	572708	
	M 15 45° (PR-2B) ³⁾	574522	
	M 18 45° (PR-2B) ³⁾	574524	
	M 22 45° (PR-2B) ³⁾	574526	
	M 28 45° (PR-2B) ³⁾	574528	
	M 35 45° (PR-2B) ³⁾	574530	
	FILTUBE Instalpress Inox	M 15	570110
		M 18	570120
		M 22	570130
M 28		570140	
M 35		570150	
M 42 (4G)		570160	
M 54 (4G)		570170	
M 42 (PR-3S) ³⁾		572706	
M 54 (PR-3S) ³⁾		572708	
M 15 45° (PR-2B) ³⁾		574522	
M 18 45° (PR-2B) ³⁾		574524	
M 22 45° (PR-2B) ³⁾		574526	
M 28 45° (PR-2B) ³⁾		574528	
M 35 45° (PR-2B) ³⁾		574530	
Fittings Estándar ECO-PRESS		RFz 16*	571325
		RFz 20*	571330
		RFz 25	571335
	RFz 32	571340	
Fittings Estándar MULTICAPA	RFz 16*	571325	
	RFz 18*	571327	
	RFz 20*	571330	
	RFz 25	571335	
Fittings Estándar PE-X	RFz 16*	571325	
	RFz 20*	571330	
	RFz 25	571335	
	RFz 32	571340	
FOHS HEIZTECHNIK FOHSPRESS	TH 16*	570460	
	TH 20*	570470	
	TH 26*	570475	
	TH 32	570480	
FORNARA ForPress	B 16*	570850	
	B 20*	570860	
	B 26	570870	
	B 32	570880	
	F 16*	570717	
	F 20*	570727	
	F 26*	570730	
	F 32	570735	
	H 16*	570320	
	H 20*	570350	
	H 26*	570370	
	H 32	570380	
	TH 16*	570460	
	TH 20*	570470	
	TH 26*	570475	
	TH 32	570480	
	U 16*	570765	
	U 20*	570775	
	U 32	570785	
	FRABO FRABOPRESS RAME (Cu)	V 12	570107
		V 15	570115
		V 18	570125
		V 22	570135
		V 28	570145
		V 35	570155
V 42		570165	
V 54		570175	
V 12 45° (PR-2B) ³⁾		574502	
V 15 45° (PR-2B) ³⁾		574504	
V 18 45° (PR-2B) ³⁾		574506	
V 22 45° (PR-2B) ³⁾		574508	
V 28 45° (PR-2B) ³⁾		574510	
V 35 45° (PR-2B) ³⁾		574512	
FRABO FRABOPRESS RAME (Cu)		V 12	570107
		V 15	570115
		V 18	570125
	V 22	570135	
	V 28	570145	
	V 35	570155	
	V 42	570165	
	V 54	570175	
	V 12 45° (PR-2B) ³⁾	574502	
	V 15 45° (PR-2B) ³⁾	574504	
	V 18 45° (PR-2B) ³⁾	574506	
	V 22 45° (PR-2B) ³⁾	574508	
	V 28 45° (PR-2B) ³⁾	574510	
	V 35 45° (PR-2B) ³⁾	574512	
	FRABO FRABOPRESS INOX 316	V 12	570107
		V 15	570115
		V 18	570125
V 22		570135	
V 28		570145	
V 35		570155	
V 42		570165	
V 54		570175	
V 12 45° (PR-2B) ³⁾		574502	
V 15 45° (PR-2B) ³⁾		574504	
V 18 45° (PR-2B) ³⁾		574506	
V 22 45° (PR-2B) ³⁾		574508	
V 28 45° (PR-2B) ³⁾		574510	
V 35 45° (PR-2B) ³⁾		574512	
FRABO FRABOPRESS C-STEEL		V 15	570115
		V 18	570125
		V 22	570135
	V 28	570145	
	V 35	570155	
	V 42	570165	
	V 54	570175	
	V 15 45° (PR-2B) ³⁾	574504	
	V 18 45° (PR-2B) ³⁾	574506	
	V 22 45° (PR-2B) ³⁾	574508	
	V 28 45° (PR-2B) ³⁾	574510	
	V 35 45° (PR-2B) ³⁾	574512	

System	Pressing contour	Art.-No.	
FRABO FRABOPRESS C-STEEL GAS	V 15	570115	
	V 18	570125	
	V 22	570135	
	V 28	570145	
	V 35	570155	
	V 15 45° (PR-2B) ³⁾	574504	
	V 18 45° (PR-2B) ³⁾	574506	
	V 22 45° (PR-2B) ³⁾	574508	
	V 28 45° (PR-2B) ³⁾	574510	
	V 35 45° (PR-2B) ³⁾	574512	
	FRABO FRABOPRESS MULTI-BRASS (MB)	TH 16*	570460
		TH 20*	570470
		TH 26*	570475
		TH 32	570480
	FRABO FRABOPRESS MULTI-PLUS (MP)	U 16*	570765
		U 20*	570775
		H 16*	570320
H 20*		570350	
FRABO SOLARPRESS	V 15	570115	
	V 18	570125	
	V 22	570135	
	V 28	570145	
	V 15 45° (PR-2B) ³⁾	574504	
	V 18 45° (PR-2B) ³⁾	574506	
	V 22 45° (PR-2B) ³⁾	574508	
	V 28 45° (PR-2B) ³⁾	574510	
	Fränkische alpex-duo	B 16*	570850
		B 18*	570855
		B 20*	570860
		B 26	570870
		B 32	570880
		F 16*	570717
		F 18*	570720
		F 20*	570727
		F 26*	570730
F 32		570735	
TH 16*		570460	
TH 18*		570465	
TH 20*	570470		
TH 26*	570475		
TH 32	570480		
Fränkische alpex F50 PROFi	F 16*	570717	
	F 20*	570727	
	F 26*	570730	
	F 32	570735	
	H 16*	570320	
	H 20*	570350	
	H 26*	570370	
	H 32	570380	
	TH 16*	570460	
	TH 20*	570470	
	TH 26*	570475	
	TH 32	570480	
(DN 26)	U 25*	570780	
	U 32	570785	
	VP 16*	570910	
	VP 20*	570915	
	VP 32	570925	
	Fränkische alpex-gas ²⁾	F 20 ²⁾	570727
		F 26 ²⁾	570730
		F 32 ²⁾	570735
		Fränkische alpex L	F 40
	F 50		570745
	F 63 (S)		572385
	F 75 (PR-3B) ³⁾		572830
gabootherm H+S	TH 10*		570467
	TH 12*		570452
	TH 14*		570455
	TH 15*		570457
	TH 16*		570460
	TH 17*		570462
	TH 18*		570465
	TH 20*		570470
	TH 25*	570495	
	TH 26*	570475	
	TH 32	570480	
	TH 40	570485	
	TH 50 (S)	572400	
	TH 63 (S)	572405	
	Geberit Mapress C-STAHl	M 12	570100
		M 15	570110
		M 18	570120
M 22		570130	
M 28		570140	
M 35		570150	
M 42 (4G)		570160	
M 54 (4G)		570170	
M 42 (PR-3S) ³⁾		572706	
M 54 (PR-3S) ³⁾		572708	
M 12 45° (PR-2B) ³⁾		574520	
M 15 45° (PR-2B) ³⁾		574522	
M 18 45° (PR-2B) ³⁾		574524	
M 22 45° (PR-2B) ³⁾		574526	
M 28 45° (PR-2B) ³⁾		574528	
M 35 45° (PR-2B) ³⁾		574530	

System	Pressing contour	Art.-No.	
Geberit Mapress EDELSTAHL	M 12	570100	
	M 15	570110	
	M 18	570120	
	M 22	570130	
	M 28	570140	
	M 35	570150	
	M 42 (4G)	570160	
	M 54 (4G)	570170	
	M 42 (PR-3S) ³⁾	572706	
	M 54 (PR-3S) ³⁾	572708	
	M 12 45° (PR-2B) ³⁾	574520	
	M 15 45° (PR-2B) ³⁾	574522	
	M 18 45° (PR-2B) ³⁾	574524	
	M 22 45° (PR-2B) ³⁾	574526	
	M 28 45° (PR-2B) ³⁾	574528	
	M 35 45° (PR-2B) ³⁾	574530	
	Geberit Mapress EDELSTAHL Gas	M 15	570110
M 18		570120	
M 22		570130	
M 28		570140	
M 35		570150	
M 42 (PR-3S) ³⁾		572706	
M 54 (PR-3S) ³⁾		572708	
M 15 45° (PR-2B) ³⁾		574522	
M 18 45° (PR-2B) ³⁾		574524	
M 22 45° (PR-2B) ³⁾		574526	
M 28 45° (PR-2B) ³⁾		574528	
M 35 45° (PR-2B) ³⁾		574530	
Geberit Mapress KUPFER		M 12	570100
		M 15	570110
		M 18	570120
		M 22	570130
		M 28	570140
	M 35	570150	
	M 42 (4G)	570160	
	M 54 (4G)	570170	
	M 42 (PR-3S) ³⁾	572706	
	M 54 (PR-3S) ³⁾	572708	
	M 12 45° (PR-2B) ³⁾	574520	
	M 15 45° (PR-2B) ³⁾	574522	
	M 18 45° (PR-2B) ³⁾	574524	
	M 22 45° (PR-2B) ³⁾	574526	
	M 28 45° (PR-2B) ³⁾	574528	
	M 35 45° (PR-2B) ³⁾	574530	
	Geberit Mapress KUPFER Gas	M 15	570110
M 18		570120	
M 22		570130	
M 28		570140	
M 35		570150	
M 42 (PR-3S) ³⁾		572706	
M 54 (PR-3S) ³⁾		572708	
M 15 45° (PR-2B) ³⁾		574522	
M 18 45° (PR-2B) ³⁾		574524	
M 22 45° (PR-2B) ³⁾		574526	
M 28 45° (PR-2B) ³⁾		574528	
M 35 45° (PR-2B) ³⁾		574530	
Geberit Mepla		G 16*	570400
		G 20*	570410
		G 26*	570420
		G 32	570430
		G 40	570440
	G 50	570450	
	G 63 (S)	572470	
	General Fittings Serie 5S00	TH 16*	570460
		TH 18*	570465
		TH 20*	570470
		TH 25*	570495
		TH 26*	570475
		TH 32	570480
		TH 40	570485
		TH 50 (S)	572400
		TH 63 (S)	572405
		H 16*	570320
H 18*		570340	
H 20*		570350	
H 25*		570360	
H 26*		570370	
H 32		570380	
H 40 (4G)		570390	
U 16*		570765	
U 18*	570770		
U 20*	570775		
U 32	570785		
U 40	570790		
U 50	570795		
U 63 (S)	572365		
U 63 (PR-3B) ³⁾	572837		
B 16*	570850		
B 18*	570855		
B 20*	570860		
B 26	570870		
B 32	570880		
General Fittings Trident	TH 16*	570460	
	TH 20*	570470	
	TH 26*	570475	
	TH 32	570480	
	H 16*	570320	
	H 20*	570350	
	H 26*	570370	
	H 32	570380	
	U 16*	570765	
	U 20*	570775	
	U 32	570785	
	B 16*	570850	
	B 20*	570860	
	B 26	570870	
	B 32	570880	

REMS pressing tongs

REMS pressing rings

Accessories for REMS radial presses (except for REMS Mini-Press ACC, REMS Mini-Press 22 V ACC) and suitable radial presses of other makes

System	Pressing contour	Art.-No.	System	Pressing contour	Art.-No.	System	Pressing contour	Art.-No.					
General Fittings	TH 16*	570460	GS	TH 14*	570455	Henco	TH 14*	570455					
Trident Gas	TH 20*	570470	Wärmesysteme	TH 16*	570460		TH 16*	570460					
	TH 26*	570475	System TH	TH 20*	570470		TH 18*	570465					
	TH 32	570480		TH 26*	570475		TH 20*	570470					
	H 16*	570320		TH 32	570480		TH 26*	570475					
	H 20*	570350		TH 40	570485		HE 32	571900					
	H 26*	570370		TH 50 (S)	572400		HE 40	571902					
	H 32	570380		TH 63 (S)	572405	Henco Gas	TH 16*	570460					
	U 16*	570765	GS	V 15	570115		TH 20*	570470					
	U 20*	570775	Wärmesysteme	V 18	570125		TH 26*	570475					
	U 32	570785	System V	V 22	570135		HE 32	571900					
Giacomini	H 16*	570320		V 28	570145		HE 40	571902					
Raccordi RM	H 20*	570350		V 35	570155	Herotec	H 16*	570320					
Giacomini	H 26*	570370		V 15 45° (PR-2B) ³⁾	574504	TEMPUS-PRESS	H 20*	570350					
	H 32	570380		V 18 45° (PR-2B) ³⁾	574506	PLUS	H 25*	570360					
	TH 16*	570460		V 22 45° (PR-2B) ³⁾	574508		H 32	570380					
	TH 20*	570470		V 28 45° (PR-2B) ³⁾	574510		TH 16*	570460					
	TH 26*	570475		V 35 45° (PR-2B) ³⁾	574512		TH 20*	570470					
	TH 32	570480	GSP Group	U 16*	570765		TH 25*	570495					
	THL 32	570487	USMetrix	U 20*	570775		TH 32	570480					
	U 16*	570765	HAGOS	TH 16*	570460		U 16*	570765					
	U 20*	570775	HakaGerodur	TH 10*	570467		U 20*	570775					
	U 32	570785	HakaGerodur-System	TH 11,6*	570482		U 25*	570780					
	U 40	570790		TH 12*	570452		U 32	570785					
	U 50	570795		TH 14*	570455		U 40	570790					
	U 63 (S)	572365		TH 16*	570460		U 50	570795					
Giacomini	H 16*	570320		TH 17*	570462		U 63 (S)	572365					
RM MULTIGAS	H 20*	570350		TH 18*	570465		U 63 (PR-3B) ³⁾	572837					
	H 26*	570370		TH 20*	570470		U 75 (PR-3B) ³⁾	572828					
	H 32	570380	HakaGerodur	TH 16*	570460		Herz pipefix	TH 10*	570467				
	TH 16*	570460	HAKASAN	TH 20*	570470		TH 16*	570460					
	TH 20*	570470		TH 25*	570495		TH 20*	570470					
	TH 26*	570475		TH 26*	570475		TH 26*	570475					
	TH 32	570480		TH 32	570480		TH 32	570480					
	THL 32	570487		TH 40	570485		TH 40	570485					
	U 16*	570765		TH 50 (S)	572400		TH 50 (S)	572400					
	U 20*	570775		TH 63 (S)	572405		TH 63 (S)	572405					
	U 32	570785		Harden 2000	TH 16*	570460	HITEC Sistema	TH 14*	570455				
Giacomini	V 15	570115	B-Hidro	TH 20*	570470		Multistrato	TH 16*	570460				
Valvole Giacomini	V 18	570125		TH 26*	570475			TH 18*	570465				
serie R850V	V 22	570135		Harden 2000	TH 14*	570455		TH 20*	570470				
	V 28	570145		Poly-Pex 2000	TH 16*	570460		TH 26*	570475				
	V 35	570155			TH 17*	570462		TH 32	570480				
	V 42	570165			TH 18*	570465		TH 40	570485				
	V 54	570175			TH 20*	570470		TH 50 (S)	572400				
	V 15 45° (PR-2B) ³⁾	574504			TH 26*	570475		TH 63 (S)	572405				
	V 18 45° (PR-2B) ³⁾	574506			THL 32	570487		Hopewell	M 15	570110			
	V 22 45° (PR-2B) ³⁾	574508			TH 40	570485		press fit system	M 18	570120			
	V 28 45° (PR-2B) ³⁾	574510			TH 50 (S)	572400			M 22	570130			
	V 35 45° (PR-2B) ³⁾	574512			TH 63 (S)	572405			M 28	570140			
	SA 15	570935			Harden 2000	TH 16*			M 35	570150			
	SA 18	570940			Poly-Pex Gas	TH 20*			M 42 (4G)	570160			
	SA 22	570945				TH 26*			M 54 (4G)	570170			
	SA 28	570950				THL 32			M 42 (PR-3S) ³⁾	572706			
	SA 35	570955							M 54 (PR-3S) ³⁾	572708			
	M 15	570110	HASTINIK	M 15	570110				hp-praski	TH 10*	570467		
	M 18	570120	Hastinik/Hitpress	M 18	570120				BAVARIA-press	TH 14*	570455		
	M 22	570130		M 22	570130					TH 16*	570460		
	M 28	570140		M 28	570140					TH 20*	570470		
	M 35	570150		M 35	570150					TH 26*	570475		
	M 15 45° (PR-2B) ³⁾	574522		M 42 (4G)	570160					TH 32	570480		
	M 18 45° (PR-2B) ³⁾	574524		M 54 (4G)	570170					TH 40	570485		
	M 22 45° (PR-2B) ³⁾	574526		M 42 (PR-3S) ³⁾	572706					TH 50 (S)	572400		
	M 28 45° (PR-2B) ³⁾	574528		M 54 (PR-3S) ³⁾	572708					TH 63 (S)	572405		
	M 35 45° (PR-2B) ³⁾	574530		M 15 45° (PR-2B) ³⁾	574522					IBP >B< Flex	U 16*	570765	
				M 18 45° (PR-2B) ³⁾	574524						U 18*	570770	
				M 22 45° (PR-2B) ³⁾	574526						U 20*	570775	
				M 28 45° (PR-2B) ³⁾	574528						U 25*	570780	
				M 35 45° (PR-2B) ³⁾	574530						U 32	570785	
											IBP >B< Press	V 12	570107
Golan Pipe	U 16*	570765	heima-press	TH 16*	570460							V 14	570112
Systems	U 20*	570775		TH 20*	570470							V 15	570115
(Scandinavia)	U 25*	570780		TH 26*	570475							V 16	570117
Alu-Pres	U 32	570785		TH 32	570480							V 18	570125
	U 40	570790		TH 40	570485							V 22	570135
	U 50	570795		TH 50 (S)	572400							V 28	570145
	U 63 (S)	572365		TH 63 (S)	572405							V 32	570155
	U 63 (PR-3B) ³⁾	572837		HELIROMA	U 16*	570765						V 42	570165
	U 75 (PR-3B) ³⁾	572828	Klimapress	U 18*	570770							V 54	570175
Grinnell G-PRESS	VUS ½" (OD 15,9 mm)	571170		U 20*	570775							V 12 45° (PR-2B) ³⁾	574502
Copper Fittings	VUS ¾" (OD 22,2 mm)	571175		U 25*	570780							V 14 45° (PR-2B) ³⁾	574532
	VUS 1" (OD 28,6 mm)	571180		U 32	570785							V 15 45° (PR-2B) ³⁾	574504
	VUS 1¼" (OD 34,9 mm)	571185		U 40	570790							V 16 45° (PR-2B) ³⁾	574534
	VUS 1½" (OD 41,3 mm)	571190		U 50	570795							V 18 45° (PR-2B) ³⁾	574506
	VUS 2" (OD 54,0 mm)	571195		U 63 (PR-3B) ³⁾	572837							V 22 45° (PR-2B) ³⁾	574508
	VUSF 2½" (PR-3B) ³⁾ (OD 66,7 mm)	572819		U 63 (S)	572365							V 28 45° (PR-2B) ³⁾	574510
	VUSF 3" (PR-3B) ³⁾ (OD 79,4 mm)	572820		U 75 (PR-3B) ³⁾	572828							V 35 45° (PR-2B) ³⁾	574512
	VUSF 4" (PR-3B) ³⁾ (OD 104,8 mm)	572821		HELIROMA	RFz 16*	571325							
				romapress	RFz 20*	571330							
					RFz 25	571335							
					RFz 32	571340							

Pressfitting systems for gas installations must only be pressed with pressing tongs/pressing rings which are highlighted in yellow. Observe the national regulations.

* These pressing tongs also fit the manual radial press REMS Eco-Press. Observe the national regulations.

- Only pressing tongs from designation "108" (1st quarter of 2008), "208" (2nd quarter of 2008) etc. can be used. The designation is stamped on every pressing jaw.
- For this pressfitting system producing a pressing joint with manual radial presses is not permitted.
- Adapter tongs are required for driving pressing rings (PR), see page 160.
- Press fittings made of red bronze (ProPress XL) must be pressed with pressing rings with press contour VUSR, copper fittings (ProPress XL-C) and stainless steel fittings (ProPress XL-S) with pressing rings with press contour VUSF.
- For taking suitable pressing inserts.
- Press fittings made of red bronze (Sanpress XL) must be pressed with pressing rings with press contour VR, copper fittings (Profipress XL, Profipress G XL), carbon steel (Prestabo XL) and stainless steel fittings (Sanpress Inox XL, Sanpress Inox G XL) with pressing rings with press contour VF.
- Driven by REMS Power-Press XL.

The suitability of REMS pressing tools for pressfitting systems: Date 09.10.2015. For the updated situation regarding suitability status check our website: www.rems.de → Downloads → Product catalogues, brochures → REMS Catalogue. Pressing tongs/pressing rings for additional pressfitting systems on request.

REMS pressing tongs

REMS pressing rings

Accessories for REMS radial presses (except for REMS Mini-Press ACC, REMS Mini-Press 22 V ACC) and suitable radial presses of other makes

System	Pressing contour	Art.-No.	
IBP >B< Press Carbon	V 12	570107	
	V 15	570115	
	V 18	570125	
	V 22	570135	
	V 28	570145	
	V 35	570155	
	V 42	570165	
	V 54	570175	
	V 12 45° (PR-2B) ³⁾	574502	
	V 15 45° (PR-2B) ³⁾	574504	
	V 18 45° (PR-2B) ³⁾	574506	
	V 22 45° (PR-2B) ³⁾	574508	
	V 28 45° (PR-2B) ³⁾	574510	
	V 35 45° (PR-2B) ³⁾	574512	
	IBP >B< Press Gas	V 15	570115
		V 18	570125
		V 22	570135
		V 28	570145
		V 35	570155
		V 42	570165
V 54		570175	
V 15 45° (PR-2B) ³⁾		574504	
V 18 45° (PR-2B) ³⁾		574506	
V 22 45° (PR-2B) ³⁾		574508	
V 28 45° (PR-2B) ³⁾		574510	
V 35 45° (PR-2B) ³⁾		574512	
IBP >B< Press Inox	V 15	570115	
	V 18	570125	
	V 22	570135	
	V 28	570145	
	V 35	570155	
	V 42	570165	
	V 54	570175	
	V 15 45° (PR-2B) ³⁾	574504	
	V 18 45° (PR-2B) ³⁾	574506	
	V 22 45° (PR-2B) ³⁾	574508	
	V 28 45° (PR-2B) ³⁾	574510	
	V 35 45° (PR-2B) ³⁾	574512	
IBP >B< Press Solar	V 15	570115	
	V 18	570125	
	V 22	570135	
	V 28	570145	
	V 35	570155	
	V 42	570165	
	V 54	570175	
	V 15 45° (PR-2B) ³⁾	574504	
	V 18 45° (PR-2B) ³⁾	574506	
	V 22 45° (PR-2B) ³⁾	574508	
	V 28 45° (PR-2B) ³⁾	574510	
	V 35 45° (PR-2B) ³⁾	574512	
Idrosanitaria Bonomi Homegas	TH 16*	570460	
	TH 20*	570470	
	TH 26*	570475	
	Idrosanitaria Bonomi Idropress	TH 16*	570460
		TH 18*	570465
TH 20*		570470	
TH 26*	570475		
TH 32	570480		
TH 40	570485		
TH 50 (S)	572400		
TH 63 (S)	572405		
IDROSISTEMI Ta-Press	TH 16*	570460	
	TH 20*	570470	
	TH 26*	570475	
	TH 32	570480	
	TH 40	570485	
	TH 50 (S)	572400	
	TH 63 (S)	572405	
	F 16*	570717	
	F 20*	570727	
	F 26*	570730	
	F 32	570735	
	F 40	570742	
	F 50	570745	
	F 63 (S)	572385	
	H 16*	570320	
	H 20*	570350	
	H 26*	570370	
	H 32	570380	
	H 40 (4G)	570390	
	U 16*	570765	
	U 20*	570775	
	C 26*	570750	
	U 32	570785	
	U 40	570790	
	U 50	570795	
	U 63 (S)	572365	
	B 16*	570850	
	B 20*	570860	
	B 26	570870	
	B 32	570880	
IPA IPANA Press	TH 10*	570467	
	TH 11,6*	570482	
	TH 12*	570452	
	TH 14*	570455	
	TH 15*	570457	
	TH 16*	570460	
	TH 17*	570462	
	TH 18*	570465	
	TH 20*	570470	
	TH 22*	570472	
	TH 25*	570495	
	TH 26*	570475	
	TH 28	570477	
	TH 32	570480	
	TH 40	570485	
TH 50 (S)	572400		
TH 63 (S)	572405		
TH 75 (PR-3B) ³⁾	572829		

System	Pressing contour	Art.-No.	
IPA THu IPANA Press	TH 16*	570460	
	TH 20*	570470	
	TH 26*	570475	
	TH 32	570480	
	TH 40	570485	
	U 16*	570765	
	U 20*	570775	
	H 16*	570320	
	H 20*	570350	
	H 26*	570370	
	H 32	570380	
	IPALPEX (Industrie du Plastique et Accessoires)	TH 14*	570455
		TH 16*	570460
		TH 18*	570465
		TH 20*	570470
TH 26*		570475	
THL 32		570487	
TH 40		570485	
TH 50 (S)		572400	
TH 63 (S)		572405	
IPLEX PIPELINES AUSTRALIA Iplex Pro-fit		K16/P18*	572600
		PF 22*	571980
IPLEX PIPELINES AUSTRALIA Iplex K1 (Gas)		K16/P18*	572600
	K/20*	572605	
	K/25*	572610	
	K32	572615	
	K1/40	572620	
	K1/50	572625	
IPLEX PIPELINES AUSTRALIA Iplex K2	K16/P18*	572600	
	K/20*	572605	
	K/25*	572610	
ISOLTUBEX ISOLPEX	RFz 16*	571325	
	RFz 20*	571330	
	RFIz 25	571337	
	RFIz 32	571342	
	ISOLTUBEX Multicapa	RFz 16*	571325
		RFz 20*	571330
RFIz 25		571337	
RFIz 32		571342	
U 16*		570765	
U 20*		570775	
U 25*	570780		
U 32	570785		
U 40	570790		
U 50	570795		
U 63 (PR-3B) ³⁾	572837		
U 63 (S)	572365		
ISOTUBI NUMEPRESS	M 15	570110	
	M 18 ¹⁾	570120	
	M 22	570130	
	M 28 ¹⁾	570140	
	M 35	570150	
	M 42 (PR-3S) ³⁾	572706	
	M 54 (PR-3S) ³⁾	572708	
	M 15 45° (PR-2B) ³⁾	574522	
	M 18 45° (PR-2B) ³⁾	574524	
	M 22 45° (PR-2B) ³⁾	574526	
	M 28 45° (PR-2B) ³⁾	574528	
	M 35 45° (PR-2B) ³⁾	574530	
	IVAR ALPEX-GAS	B 20*	570860
		B 26	570870
		B 32	570880
IVAR Ivar-Press	B 14*	570845	
	B 16*	570850	
	B 18*	570855	
	B 20*	570860	
	B 26	570870	
	B 32	570880	
	F 40	570742	
	F 50	570745	
	F 63 (S)	572385	
	IVAR MULTI PRESS GAS	TH 16*	570460
		TH 20*	570470
		TH 26*	570475
TH 32		570480	
B 16*		570850	
B 20*		570860	
B 26		570870	
B 32		570880	
IVAR MULTI PRESS GAS ITALIA		TH 16*	570460
		TH 20*	570470
		TH 26*	570475
		TH 32	570480
	B 16*	570850	
	B 20*	570860	
	B 26	570870	
	B 32	570880	

System	Pressing contour	Art.-No.
IVAR Multi Press MP	TH 16*	570460
	TH 18*	570465
	TH 20*	570470
	TH 25*	570495
	TH 26*	570475
	TH 32	570480
	TH 40	570485
	TH 50 (S)	572400
	TH 63 (S)	572405
	F 16*	570717
	F 18*	570720
	F 20*	570727
	F 26*	570730
	F 32	570735
	F 40	570742
	F 50	570745
	F 63 (S)	572385
	H 16*	570320
	H 18*	570340
	H 20*	570350
	H 25*	570360
	H 26*	570370
	H 32	570380
	H 40 (4G)	570390
	U 16*	570765
	U 18*	570770
	U 20*	570775
	U 25*	570780
	C 26*	570750
	U 32	570785
U 40	570790	
U 50	570795	
U 63 (S)	572365	
B 16*	570850	
B 18*	570855	
B 20*	570860	
B 26	570870	
B 32	570880	
IVAR Multi Press Leak (MPL)	TH 16*	570460
	TH 20*	570470
	TH 26*	570475
	TH 32	570480
	F 16*	570717
	F 20*	570727
F 26*	570730	
F 32	570735	
H 16*	570320	
H 20*	570350	
H 26*	570370	
H 32	570380	
U 16*	570765	
U 20*	570775	
C 26*	570750	
U 32	570785	
B 16*	570850	
B 20*	570860	
B 26	570870	
B 32	570880	
IVAR Plastic Multi Press PMP	TH 16*	570460
	TH 20*	570470
	TH 25*	570495
	TH 26*	570475
	TH 32	570480
	F 16*	570717
	F 20*	570727
	F 26*	570730
	F 32	570735
	H 16*	570320
	H 20*	570350
	H 25*	570360
H 26*	570370	
H 32	570380	
U 16*	570765	
U 20*	570775	
U 25*	570780	
C 26*	570750	
U 32	570785	
B 16*	570850	
B 20*	570860	
B 26	570870	
B 32	570880	
IVAR Plastic Multi Press Leak (PMPL)	TH 16*	570460
	TH 20*	570470
	TH 26*	570475
	TH 32	570480
	F 16*	570717
	F 20*	570727
	F 26*	570730
	F 32	570735
	H 16*	570320
	H 20*	570350
	H 26*	570370
	H 32	570380
U 16*	570765	
U 20*	570775	
C 26*	570750	
U 32	570785	
B 16*	570850	
B 20*	570860	
B 26	570870	
B 32	570880	
Jäger - Aquatec Aquapress H	H 14*	570310
	H 16*	570320
	H 17*	570330
	H 18*	570340
	H 20*	570350
	H 26*	570370
	H 32	570380
	U 40	570790
	U 50	570795
	U 63 (S)	572365

System	Pressing contour	Art.-No.
LK Systems	V 15	570115
LK >B<Press	V 18	570125
Gas	V 22	570135
	V 28	570145
	V 35	570155
	V 42	570165
	V 54	570175
	V 15 45° (PR-2B) ³⁾	574504
	V 18 45° (PR-2B) ³⁾	574506
	V 22 45° (PR-2B) ³⁾	574508
	V 28 45° (PR-2B) ³⁾	574510
	V 35 45° (PR-2B) ³⁾	574512
LK Systems	TH 16*	570460
LK Universal	TH 20*	570470
	TH 25*	570495
	TH 32	570480
	TH 40	570485
	TH 50 (S)	572400
	TH 63 (S)	572405
LVI-DAHL	U 16*	570765
Altech-Alupex	U 20*	570775
	U 25*	570780
	U 32	570785
MAINCOR	U 16*	570765
MAINPRESS	U 20*	570775
	U 25*	570780
	U 32	570785
MAINCOR	U 16*	570765
MAINFLOR	U 20*	570775
MAINCOR	M 15	570110
MAINOX	M 18 ¹⁾	570120
	M 22	570130
	M 28 ¹⁾	570140
	M 35	570150
	M 42 (PR-3S) ³⁾	572706
	M 54 (PR-3S) ³⁾	572708
Mair Heiztechnik	M 12	570100
Gomafix Cu/E	M 15	570110
	M 18 ¹⁾	570120
	M 22	570130
	M 12 45° (PR-2B) ³⁾	574520
	M 15 45° (PR-2B) ³⁾	574522
	M 18 45° (PR-2B) ³⁾	574524
	M 22 45° (PR-2B) ³⁾	574526
Mair Heiztechnik	H 11,5*	570315
Gomafix M	H 14*	570310
	H 16*	570320
	H 20*	570350
	H 26*	570370
	H 32	570380
	H 40	570390
Mair Heiztechnik	H 11,5*	570315
M-Press	H 14*	570310
	H 16*	570320
	H 20*	570350
	H 26*	570370
	H 32	570380
	H 40	570390
Ma.s.ter System	TH 14*	570455
PRESSMASTER	TH 16*	570460
	TH 18*	570465
	TH 20*	570470
	TH 25*	570495
	TH 26*	570475
	TH 32	570480
	TH 40	570485
	TH 50 (S)	572400
	TH 63 (S)	572405
	H 14*	570310
	H 16*	570320
	H 18*	570340
	H 20*	570350
	H 26*	570370
	H 32	570380
	H 40 (4G)	570390
	U 14*	570760
	U 16*	570765
	U 18*	570770
	U 20*	570775
	U 25*	570780
	U 32	570785
	U 40	570790
	U 50	570795
	U 63 (PR-3B) ³⁾	572837
	U 63 (S)	572365
MEGAR0	H 11,5*	570315
HAKAPRESS	H 14*	570310
	H 16*	570320
	H 17*	570330
	H 18*	570340
	H 20*	570350
	H 26*	570370
	H 32	570380
	H 40 (4G)	570390
	U 40	570790
	F 50	570745
	F 63 (S)	572385
MEGAR0	B 16*	570850
MEGAPRESS	B 20*	570860
	B 26	570870
	B 32	570880
	F 40	570742
	F 50	570745
	F 63 (S)	572385

System	Pressing contour	Art.-No.
MEGAR0	B 16*	570850
MEGAPRESS MP	B 20*	570860
	B 26	570870
	B 32	570880
	F 16*	570715
	F 20*	570725
	F 26*	570730
	F 32	570735
	F 40	570742
	F 50	570745
	F 63 (S)	572385
	H 16*	570320
	H 20*	570350
	H 26*	570370
	H 32	570380
	TH 16*	570460
	TH 20*	570470
	TH 26*	570475
	TH 32	570480
	TH 40	570485
	TH 50 (S)	572400
	TH 63 (S)	572405
	U 16*	570765
	U 20*	570775
	U 32	570785
MEGAR0	B 16*	570850
MEGAPRESS	B 20*	570860
MPL	B 26	570870
	B 32	570880
	F 16*	570715
	F 20*	570725
	F 26*	570730
	F 32	570735
	F 40	570742
	F 50	570745
	F 63 (S)	572385
	H 16*	570320
	H 20*	570350
	H 26*	570370
	H 32	570380
	TH 16*	570460
	TH 20*	570470
	TH 26*	570475
	TH 32	570480
	TH 40	570485
	TH 50 (S)	572400
	TH 63 (S)	572405
	U 16*	570765
	U 20*	570775
	U 32	570785
METALGRUP	RFz 16*	571325
PexGrup	RFz 20*	571330
	RFz 25	571335
	RFz 32	571340
METALGRUP	U 16*	570765
MultiGrup	U 18*	570770
	U 20*	570775
	U 25*	570780
	U 32	570785
MULTITHERM	TH 16*	570460
PRESSSYSTEM	TH 20*	570470
	TH 26*	570475
	TH 32	570480
	TH 40	570485
	TH 50 (S)	572400
	TH 63 (S)	572405
	TH 75 (PR-3B) ³⁾	572829
Multicapac	RFz 16*	571325
Industrial	RFz 20*	571330
AIS PEX	RFz 25	571335
	RFz 32	571340
	U 16*	570765
	U 20*	570775
	U 25*	570780
	U 32	570785
Multicapac	MT 20*	571744
Industrial	MT 25*	571746
multitubo systems	MT 32	571748
MC	U 16*	570765
	U 18*	570770
	U 20*	570775
	U 25*	570780
	U 32	570785
	U 40	570790
	U 50	570795
	U 63 (S)	572365
	U 63 (PR-3B) ³⁾	572837
	U 75 (PR-3B) ³⁾	572828
Multicapac	H 16*	570320
Industrial	H 20*	570350
multitubo systems	H 25*	570360
MM	H 26*	570370
	H 32	570380
	MT 20*	571744
	MT 25*	571746
	MT 32	571748
	RFz 16*	571325
	RFz 20*	571330
	RFz 25	571335
	RFz 32	571340
	TH 16*	570460
	TH 20*	570470
	TH 25*	570495
	TH 26*	570475
	TH 32	570480
	U 16*	570765
	U 20*	570775
	U 25*	570780
	U 32	570785
Multi-Flex ACR	H 12* (3/4")	570300
	U 14* (3/4")	570760
	U 16* (1/2")	570765
	U 18* (3/4")	570770
	U 20* (1/2")	570775
	U 25* (3/8")	570780
	U 32 (1 1/4")	570785

System	Pressing contour	Art.-No.
Multi-Flex Gas	U 16* (1/2")	570765
	U 20* (3/4")	570775
	U 25* (3/4")	570780
	U 32 (1")	570785
	U 40 (1 1/4")	570790
	U 50 (1 1/2")	570795
	U 63 (PR-3B) ³⁾ (2")	572837
	U 63 (S) (2")	572365
	U 75 (PR-3B) ³⁾ (2 1/2")	572828
Multi-Flex Water	U 16* (1/2")	570765
	U 25* (3/4")	570780
	U 32 (1")	570785
	U 40 (1 1/4")	570790
	U 50 (1 1/2")	570795
	U 63 (PR-3B) ³⁾ (2")	572837
	U 63 (S) (2")	572365
	U 75 (PR-3B) ³⁾ (2 1/2")	572828
NEUTHERM	H 16*	570320
MEKUPRESS-HT	H 20*	570350
	H 26*	570370
	H 32	570380
	H 40 (4G)	570390
	U 40	570790
NIBCO (USA)	VUS 1/2" (OD 15,9 mm)	571770
Press System	VUS 3/4" (OD 22,2 mm)	571775
Copper	VUS 1" (OD 28,6 mm)	571780
	VUS 1 1/4" (OD 34,9 mm)	571785
	VUS 1 1/2" (OD 41,3 mm)	571790
	VUS 2" (OD 54,0 mm)	571795
Nicoll Fluxo	TH 16*	570460
	TH 20*	570470
	TH 26*	570475
	TH 32	570480
	TH 40	570485
	TH 50 (S)	572400
	TH 63 (S)	572405
	TH 75 (PR-3B) ³⁾	572829
NUPIGECO	U 14*	570760
Multi-nupi	U 16*	570765
	U 18*	570770
	U 20*	570775
	C 26*	570750
	U 32	570785
	U 40	570790
	U 50	570795
	U 63 (PR-3B) ³⁾	572837
	U 63 (S)	572365
NUPIGECO	B 16*	570850
Multi-pinze	B 18*	570855
	B 20*	570860
	B 26	570870
	B 32	570880
	F 16*	570715
	F 18*	570720
	F 20*	570725
	F 26*	570730
	F 32	570735
	H 16*	570320
	H 18*	570340
	H 20*	570350
	H 26*	570370
	H 32	570380
	TH 16*	570460
	TH 18*	570465
	TH 20*	570470
	TH 26*	570475
	TH 32	570480
	U 16*	570765
	U 18*	570770
	U 20*	570775
	C 26*	570750
	U 32	570785
Nussbaum	VP 16*	570910
Optiflex Press	VP 20*	570915
	VP 25*	570920
	VP 32	570925
Nussbaum	V 15	570115
Optipress	V 18	570125
Aquaplus	V 22	570135
	V 28	570145
	V 35	570155
	V 42	570165
	V 54	570175
	VF 64,0 (PR-3B) ³⁾	572815
	VF 76,1 (PR-3B) ³⁾	572816
	VF 88,9 (PR-3B) ³⁾	572817
	VF 108,0 (PR-3B) ³⁾	572818
	V 15 45° (PR-2B) ³⁾	574504
	V 18 45° (PR-2B) ³⁾	574506
	V 22 45° (PR-2B) ³⁾	574508
	V 28 45° (PR-2B) ³⁾	574510
	V 35 45° (PR-2B) ³⁾	574512
Nussbaum	V 15	570115
Optipress-Gaz	V 18	570125
	V 22	570135
	V 28	570145
	V 35	570155
	V 42	570165
	V 54	570175
	VF 64,0 (PR-3B) ³⁾	572815
	VF 76,1 (PR-3B) ³⁾	572816
	VF 88,9 (PR-3B) ³⁾	572817
	VF 108,0 (PR-3B) ³⁾	572818
	V 15 45° (PR-2B) ³⁾	574504
	V 18 45° (PR-2B) ³⁾	574506
	V 22 45° (PR-2B) ³⁾	574508
	V 28 45	

REMS pressing tongs REMS pressing rings

Accessories for REMS radial presses (except for REMS Mini-Press ACC, REMS Mini-Press 22 V ACC) and suitable radial presses of other makes

System	Pressing contour	Art.-No.	
Nussbaum Optipress-Therm	V 15	570115	
	V 18	570125	
	V 22	570135	
	V 28	570145	
	V 35	570155	
	V 42	570165	
	V 54	570175	
	VF 64,0 (PR-3B) ³⁾	572815	
	VF 76,1 (PR-3B) ³⁾	572816	
	VF 88,9 (PR-3B) ³⁾	572817	
	VF 108,0 (PR-3B) ³⁾	572818	
	V 15 45° (PR-2B) ³⁾	574504	
	V 18 45° (PR-2B) ³⁾	574506	
	V 22 45° (PR-2B) ³⁾	574508	
	V 28 45° (PR-2B) ³⁾	574510	
	V 35 45° (PR-2B) ³⁾	574512	
	O.M.T. - Press	TH 16*	570460
		TH 20*	570470
		TH 26*	570475
		TH 32	570480
TH 40		570485	
Oventrop Cofit P	H 16 A*	570620	
	H 20 A*	570650	
	H 26 A*	570670	
	H 32 A	570680	
	H 40 A	570690	
	U 50	570795	
PBTub SERTIPRESS	RFz 12*	571320	
	RFz 16*	571325	
	RFz 20*	571330	
	RFz 25	571335	
		571340	
PBTub SERTI-STEEL	M 15	570110	
	M 18	570120	
	M 22	570130	
	M 28	570140	
	M 35	570150	
	M 42 (PR-3S) ³⁾	572706	
	M 54 (PR-3S) ³⁾	572708	
	M 15 45° (PR-2B) ³⁾	574522	
	M 18 45° (PR-2B) ³⁾	574524	
	M 22 45° (PR-2B) ³⁾	574526	
	M 28 45° (PR-2B) ³⁾	574528	
	M 35 45° (PR-2B) ³⁾	574530	
	Pegler Yorkshire Henco Multilayer Solutions	TH 14*	570455
TH 16*		570460	
TH 18*		570465	
TH 20*		570470	
TH 26*		570475	
HE 32		571900	
Pegler Yorkshire XPress Carbon	M 12	570100	
	M 15	570110	
	M 18 ¹⁾	570120	
	M 22	570130	
	M 28 ¹⁾	570140	
	M 35	570150	
	M 42 (PR-3S) ³⁾	572706	
	M 54 (PR-3S) ³⁾	572708	
	M 12 45° (PR-2B) ³⁾	574520	
	M 15 45° (PR-2B) ³⁾	574522	
	M 18 45° (PR-2B) ³⁾	574524	
	M 22 45° (PR-2B) ³⁾	574526	
	M 28 45° (PR-2B) ³⁾	574528	
	M 35 45° (PR-2B) ³⁾	574530	
	Pegler Yorkshire XPress Copper	M 12	570100
M 15		570110	
M 18 ¹⁾		570120	
M 22		570130	
M 28 ¹⁾		570140	
M 35		570150	
M 42 (PR-3S) ³⁾		572706	
M 54 (PR-3S) ³⁾		572708	
M 12 45° (PR-2B) ³⁾		574520	
M 15 45° (PR-2B) ³⁾		574522	
M 18 45° (PR-2B) ³⁾		574524	
M 22 45° (PR-2B) ³⁾		574526	
M 28 45° (PR-2B) ³⁾		574528	
M 35 45° (PR-2B) ³⁾		574530	
Pegler Yorkshire XPress Copper Gas		M 15	570110
	M 18 ¹⁾	570120	
	M 22	570130	
	M 28 ¹⁾	570140	
	M 35	570150	
	M 42 (PR-3S) ³⁾	572706	
	M 54 (PR-3S) ³⁾	572708	
	M 15 45° (PR-2B) ³⁾	574522	
	M 18 45° (PR-2B) ³⁾	574524	

System	Pressing contour	Art.-No.	
Pegler Yorkshire XPress Solar	M 15	570110	
	M 18 ¹⁾	570120	
	M 22	570130	
	M 28 ¹⁾	570140	
	M 35	570150	
	M 42 (PR-3S) ³⁾	572706	
	M 54 (PR-3S) ³⁾	572708	
	M 15 45° (PR-2B) ³⁾	574522	
	M 18 45° (PR-2B) ³⁾	574524	
	M 22 45° (PR-2B) ³⁾	574526	
	M 28 45° (PR-2B) ³⁾	574528	
	M 35 45° (PR-2B) ³⁾	574530	
	Pegler Yorkshire XPress Stainless	M 15	570110
		M 18 ¹⁾	570120
		M 22	570130
M 28 ¹⁾		570140	
M 35		570150	
M 42 (PR-3S) ³⁾		572706	
M 54 (PR-3S) ³⁾		572708	
M 15 45° (PR-2B) ³⁾		574522	
M 18 45° (PR-2B) ³⁾		574524	
M 22 45° (PR-2B) ³⁾		574526	
M 28 45° (PR-2B) ³⁾		574528	
M 35 45° (PR-2B) ³⁾		574530	
Pegler Yorkshire XPress Stainless Gas		M 15	570110
		M 18 ¹⁾	570120
		M 22	570130
	M 28 ¹⁾	570140	
	M 35	570150	
	M 42 (PR-3S) ³⁾	572706	
	M 54 (PR-3S) ³⁾	572708	
	M 15 45° (PR-2B) ³⁾	574522	
	M 18 45° (PR-2B) ³⁾	574524	
	M 22 45° (PR-2B) ³⁾	574526	
	M 28 45° (PR-2B) ³⁾	574528	
	M 35 45° (PR-2B) ³⁾	574530	
	PERFEXIM "PERFEKT SYSTEM"	U 16*	570765
		U 20*	570775
		U 25*	570780
U 32		570785	
		570790	
PERFILTUBO PERFILALUPEX	U 16*	570765	
	U 18*	570770	
	U 20*	570775	
	U 25*	570780	
	U 32	570785	
PERFILTUBO PERFILPRESS	M 15	570110	
	M 18	570120	
	M 22	570130	
	M 28	570140	
	M 35	570150	
	M 42 (4G)	570160	
	M 54 (4G)	570170	
	M 42 (PR-3S) ³⁾	572706	
	M 54 (PR-3S) ³⁾	572708	
	M 15 45° (PR-2B) ³⁾	574522	
	M 18 45° (PR-2B) ³⁾	574524	
	M 22 45° (PR-2B) ³⁾	574526	
	M 28 45° (PR-2B) ³⁾	574528	
	M 35 45° (PR-2B) ³⁾	574530	
	PEXTUBE PexTube	RFz 16*	571325
RFz 20*		571330	
RFz 25		571337	
RFz 32		571342	
		571347	
Pipelife C-PRESS	M 15	570110	
	M 18	570120	
	M 22	570130	
	M 28	570140	
	M 35	570150	
	M 42 (PR-3S) ³⁾	572706	
	M 54 (PR-3S) ³⁾	572708	
	M 15 45° (PR-2B) ³⁾	574522	
	M 18 45° (PR-2B) ³⁾	574524	
	M 22 45° (PR-2B) ³⁾	574526	
	M 28 45° (PR-2B) ³⁾	574528	
	M 35 45° (PR-2B) ³⁾	574530	
	Pipelife RADOPRESS	TH 16*	570460
		TH 18*	570465
		TH 20*	570470
TH 26*		570475	
TH 32		570480	
TH 40		570485	
TH 63 (S)		572405	

System	Pressing contour	Art.-No.	
Pipetec Connect	TH 16*	570460	
	TH 20*	570470	
	TH 26*	570475	
	TH 32	570480	
	TH 40	570485	
	TH 50 (S)	572400	
PLASTICA ALFA Multiplex	TH 63 (S)	572405	
	H 16*	570320	
	H 20*	570350	
	H 26*	570370	
	H 32	570380	
	U 16*	570765	
PLASTICA ALFA Multipexalfa Gas	U 20*	570775	
	C 26*	570750	
	U 32	570785	
	H 16*	570320	
	H 20*	570350	
	H 26*	570370	
PLASTICA ALFA Multipexalfa Gas protek	H 16*	570320	
	H 20*	570350	
	H 26*	570370	
	H 16*	570320	
	H 20*	570350	
	H 26*	570370	
PLASTICA ALFA Multipex Air	H 16*	570320	
	H 20*	570350	
	H 26*	570370	
	H 32	570380	
	U 16*	570765	
	U 20*	570775	
PLASTICA ALFA Multipex Plus	C 26*	570750	
	U 32	570785	
	H 16*	570320	
	H 20*	570350	
	H 26*	570370	
	H 32	570380	
PLASTICA ALFA Multipex Thermo Plus	U 16*	570765	
	U 18*	570770	
	U 20*	570775	
	U 25*	570780	
	U 32	570785	
	U 40	570790	
PLÁSTICOS FERRO FERROPLAST GPF GAS	H 16*	570320	
	H 20*	570350	
	H 26*	570370	
	H 32	570380	
	U 16*	570765	
	U 20*	570775	
	U 25*	570780	
	U 32	570785	
	U 40	570790	
	U 50	570795	
	U 63 (PR-3B) ³⁾	572837	
	U 63 (S)	572365	
	U 75 (PR-3B) ³⁾	572828	
	PLÁSTICOS FERRO FERROPLAST GPF GAS	M 15	570110
		M 18	570120
M 22		570130	
M 28		570140	
M 35		570150	
M 42 (4G)		570160	
M 54 (4G)		570170	
M 42 (PR-3S) ³⁾		572706	
M 54 (PR-3S) ³⁾		572708	
M 15 45° (PR-2B) ³⁾		574522	
M 18 45° (PR-2B) ³⁾		574524	
M 22 45° (PR-2B) ³⁾		574526	
M 28 45° (PR-2B) ³⁾		574528	
M 35 45° (PR-2B) ³⁾		574530	
PLUMBING PLUS EziPex Crimp (AUS)		RFz 16*	571325
	RFz 20*	571330	
	RFz 25	571337	
	RFz 32	571342	
	K/20*	572605	
	K/25*	572610	
PLUMBING PLUS EziPex Gas (AUS)	K32	572615	
	K1/40	572620	
	K1/50	572625	
	K16/P18*	572600	
	K/20*	572605	
	K/25*	572610	
PLUMBING PLUS EziPex Gas (AUS)	K32	572615	
	K1/40	572620	
	K1/50	572625	
	VAU 15 (OD 12,7 mm)	572687	
	VAU 20 (OD 19,1 mm)	572689	
	VAU 25 (OD 25,4 mm)	572691	
	VAU 32 (OD 31,8 mm)	572693	
	VAU 40 (OD 38,1 mm)	572695	
	VAU 50 (OD 50,8 mm)	572697	
	VAUF 65 (PR-3B) ³⁾	572839	
	(OD 63,5 mm)		
	VAUF 80 (PR-3B) ³⁾	572840	
	(OD 76,2 mm)		
	VAUF 100 (PR-3B) ³⁾	572841	
	(OD 101,6 mm)		
PLUMBING PLUS EziPress Solar (AUS)	VAU 15 (OD 12,7 mm)	572687	
	VAU 20 (OD 19,1 mm)	572689	
	VAU 25 (OD 25,4 mm)	572691	

Pressfitting systems for gas installations must only be pressed with pressing tongs/pressing rings which are highlighted in yellow. Observe the national regulations.

* These pressing tongs also fit the manual radial press REMS Eco-Press. Observe the national regulations.

- Only pressing tongs from designation "108" (1st quarter of 2008), "208" (2nd quarter of 2008) etc. can be used. The designation is stamped on every pressing jaw.
- For this pressfitting system producing a pressing joint with manual radial presses is not permitted.
- Adapter tongs are required for driving pressing rings (PR), see page 160.
- Press fittings made of red bronze (ProPress XL) must be pressed with pressing rings with press contour VUSR, copper fittings (ProPress XL-C) and stainless steel fittings (ProPress XL-S) with pressing rings with press contour VUSF.
- For taking suitable pressing inserts.
- Press fittings made of red bronze (Sanpress XL) must be pressed with pressing rings with press contour VR, copper fittings (Profipress XL, Profipress G XL), carbon steel (Prestabo XL) and stainless steel fittings (Sanpress Inox XL, Sanpress Inox G XL) with pressing rings with press contour VF.
- Driven by REMS Power-Press XL.

The suitability of REMS pressing tools for pressfitting systems: Date 09.10.2015. For the updated situation regarding suitability status check our website: www.rems.de → Downloads → Product catalogues, brochures → REMS Catalogue.

Pressing tongs/pressing rings for additional pressfitting systems on request.

REMS pressing tongs

REMS pressing rings

Accessories for REMS radial presses (except for REMS Mini-Press ACC, REMS Mini-Press 22 V ACC) and suitable radial presses of other makes

System	Pressing contour	Art.-No.	
PLUMBING PLUS EziPress Water (AUS)	VAU 15 (OD 12,7 mm)	572687	
	VAU 20 (OD 19,1 mm)	572689	
	VAU 25 (OD 25,4 mm)	572691	
	VAU 32 (OD 31,8 mm)	572693	
	VAU 40 (OD 38,1 mm)	572695	
	VAU 50 (OD 50,8 mm)	572697	
	VAUF 65 (PR-3B) ³⁾	572839	
	VAUF 80 (PR-3B) ³⁾	572840	
	VAUF 76,2 mm		
	VAUF 100 (PR-3B) ³⁾	572841	
POLYPIPE POLYPRESS	F 16*	570715	
	F 20*	570725	
	F 26*	570730	
	F 32	570735	
	F 40	570742	
	F 50	570745	
	F 63 (S)	572385	
	F 75 (PR-3B) ³⁾	572830	
POLYPIPE POLYSURE	TH 10*	570467	
	TH 15*	570457	
	TH 22*	570472	
	TH 28	570477	
POLYSAN Handelsges. m.b.H. & Co KG (Krems/Öster- reich)	M 15	570110	
	M 18	570120	
	M 22	570130	
	M 28	570140	
	M 35	570150	
	M 42 (PR-3S) ³⁾	572706	
	M 54 (PR-3S) ³⁾	572708	
	M 15 45° (PR-2B) ³⁾	574522	
	M 18 45° (PR-2B) ³⁾	574524	
	M 22 45° (PR-2B) ³⁾	574526	
	M 28 45° (PR-2B) ³⁾	574528	
	M 35 45° (PR-2B) ³⁾	574530	
	POLYSAN Handelsges. m.b.H. & Co KG (Krems/Öster- reich)	V 15	570115
V 18		570125	
V 22		570135	
V 28		570145	
V 35		570155	
V 42		570165	
V 54		570175	
V 15 45° (PR-2B) ³⁾		574504	
V 18 45° (PR-2B) ³⁾		574506	
V 22 45° (PR-2B) ³⁾		574508	
V 28 45° (PR-2B) ³⁾		574510	
V 35 45° (PR-2B) ³⁾		574512	
POLYSAN Handelsges. m.b.H. & Co KG (Krems/Öster- reich)		M 15	570110
	M 18	570120	
	M 22	570130	
	M 28	570140	
	M 35	570150	
	M 42 (PR-3S) ³⁾	572706	
	M 54 (PR-3S) ³⁾	572708	
	M 15 45° (PR-2B) ³⁾	574522	
	M 18 45° (PR-2B) ³⁾	574524	
	M 22 45° (PR-2B) ³⁾	574526	
	M 28 45° (PR-2B) ³⁾	574528	
	M 35 45° (PR-2B) ³⁾	574530	
	POLYSAN Edelstahl Press-System Gas	M 15	570110
M 18		570120	
M 22		570130	
M 28		570140	
M 35		570150	
M 42 (PR-3S) ³⁾		572706	
M 54 (PR-3S) ³⁾		572708	
M 15 45° (PR-2B) ³⁾		574522	
M 18 45° (PR-2B) ³⁾		574524	
M 22 45° (PR-2B) ³⁾		574526	
M 28 45° (PR-2B) ³⁾		574528	
M 35 45° (PR-2B) ³⁾		574530	
POLYSAN Handelsges. m.b.H. & Co KG (Krems/Öster- reich)		M 15	570110
	M 18	570120	
	M 22	570130	
	M 28	570140	
	M 35	570150	
	M 42 (PR-3S) ³⁾	572706	
	M 54 (PR-3S) ³⁾	572708	
	M 15 45° (PR-2B) ³⁾	574522	
	M 18 45° (PR-2B) ³⁾	574524	
	M 22 45° (PR-2B) ³⁾	574526	
	M 28 45° (PR-2B) ³⁾	574528	
	M 35 45° (PR-2B) ³⁾	574530	
	POLYSAN Edelstahl Press-System Wasser	TH 14*	570455
TH 16*		570460	
TH 17*		570462	
TH 18*		570465	
TH 20*		570470	
TH 28*		570475	
TH 32		570480	
TH 40		570485	
TH 50 (S)		572400	
TH 63 (S)		572405	
TH 75 (PR-3B) ³⁾		572829	
POLYSAN Handelsges. m.b.H. & Co KG (Krems/Öster- reich)		TH 14*	570455
		TH 16*	570460
	TH 17*	570462	
	TH 18*	570465	
	TH 20*	570470	
	TH 28*	570475	
	TH 32	570480	
	TH 40	570485	
	TH 50 (S)	572400	
	TH 63 (S)	572405	
	TH 75 (PR-3B) ³⁾	572829	
	POLYSAN-Henco- Press-System	TH 26*	570475
		HE 32	571900
HE 40		571902	
U 16*		570765	
U 18*		570770	
POLYSAN (España) Rainbow	U 20*	570775	
	U 25*	570780	
	U 32	570785	
	U 40	570790	
	U 50	570795	
	U 63 (PR-3B) ³⁾	572837	
	U 63 (S)	572365	
	H 14*	570310	
	H 16*	570320	
	H 18*	570340	
	H 20*	570350	
H 26*	570370		
H 32	570380		
U 40	570790		
U 50	570795		
U 63 (PR-3B) ³⁾	572837		
H 14*	570310		
H 16*	570320		
H 18*	570340		
H 20*	570350		
H 26*	570370		
H 32	570380		
TH 16*	570460		
TH 18*	570465		
TH 20*	570470		
TH 26*	570475		
TH 32	570480		
U 16*	570765		
U 18*	570770		
U 20*	570775		

System	Pressing contour	Art.-No.		
Raccorderie Metalliche aesPRES ¹⁾	M 15	570110		
	M 18	570120		
	M 22	570130		
	M 28	570140		
	M 35	570150		
	M 42 (PR-3S) ³⁾	572706		
	M 54 (PR-3S) ³⁾	572708		
	Raccorderie Metalliche inoxPRES ¹⁾	M 15	570110	
		M 18	570120	
		M 22	570130	
		M 28	570140	
		M 35	570150	
		M 42 (PR-3S) ³⁾	572706	
M 54 (PR-3S) ³⁾		572708		
Raccorderie Metalliche steelPRES ¹⁾		M 15	570110	
		M 18	570120	
		M 22	570130	
		M 28	570140	
		M 35	570150	
		M 42 (PR-3S) ³⁾	572706	
	M 54 (PR-3S) ³⁾	572708		
	RBM Tita-gas	TH 16*	570460	
		TH 20*	570470	
		TH 26*	570475	
		TH 32	570480	
		RBM Tita-fix	B 14*	570845
			B 16*	570850
B 18*			570855	
B 20*			570860	
B 26			570870	
F 16*			570715	
F 20*			570725	
H 14*			570310	
H 16*			570320	
H 18*	570340			
H 20*	570350			
H 26*	570370			
H 32	570380			
TH 14*	570455			
TH 16*	570460			
TH 18*	570465			
TH 20*	570470			
TH 26*	570475			
TH 32	570480			
TH 40	570485			
TH 50 (S)	572400			
TH 63 (S)	572405			
U 14*	570760			
U 16*	570765			
U 18*	570770			
U 20*	570775			
Redi Nicoll Fluxo	TH 14*	570455		
	TH 16*	570460		
	TH 18*	570465		
	TH 20*	570470		
	TH 26*	570475		
	TH 32	570480		
	TH 40	570485		
	TH 50 (S)	572400		
	TH 63 (S)	572405		
	TH 75 (PR-3B) ³⁾	572829		
	Redi Nicoll Fluxo Gas	TH 16*	570460	
		TH 20*	570470	
		TH 26*	570475	
U 40		570790		
RIFENG U PRESS FITTING (F5)	U 14*	570760		
	U 16*	570765		
	U 18*	570770		
	U 20*	570775		
	U 25*	570780		
	U 32	570785		
	U 40	570790		
	U 50	570795		
	U 63 (S)	572365		
	U 63 (PR-3B) ³⁾	572837		
	U 75 (PR-3B) ³⁾	572828		
	RIFENG TH PRESS FITTING (F9)	TH 16*	570460	
		TH 20*	570470	
TH 25*		570495		
TH 26*		570475		
TH 32		570480		
TH 40		570485		
TH 50 (S)		572400		
TH 63 (S)		572405		
RIQUIER A SERTIR		RFz 12*	571320	
		RFz 16*	571325	
		RFz 20*	571330	
		RFz 25	571335	
		U 32	570785	
Roth	RN 14*	572672		
	RN 17*	572674		
	RN 20*	572676		
	RN 25/26	572678		
	RN 32	572680		
	TH 16*	570460		
Roth España - Global Plastic Rothapress	TH 18*	570465		
	TH 20*	570470		
	TH 25*	570495		
	TH 32	570480		
	TH 40	570485		
	TH 50 (S)	572400		
	TH 63 (S)	572405		
	Roth Nordic Alu-LaserPlus/ PressCheck ²⁾ (DNK-NOR-SWE-FIN)	RN 16	572670	
		RN 20	572676	
		RN 25/26	572678	
		RN 32	572680	
		M 15	570110	
	Rubinetteria Bresciane Bonomi TURBO INOX	M 18	570120	
M 22		570130		
M 28		570140		
M 35		570150		
M 42 (PR-3S) ³⁾		572706		
M 54 (PR-3S) ³⁾		572708		
M 15 45° (PR-2B) ³⁾		574522		
M 18 45° (PR-2B) ³⁾		574524		
M 22 45° (PR-2B) ³⁾		574526		
M 28 45° (PR-2B) ³⁾		574528		
M 35 45° (PR-2B) ³⁾		574530		
Rubinetteria Bresciane Bonomi TURBO PRESS		TH 14*	570455	
		TH 16*	570460	
	TH 18*	570465		
	TH 20*	570470		
	TH 26*	570475		
	TH 32	570480		
	TH 40	570485		
	TH 50 (S)	572400		
	TH 63 (S)	572405		
	Rubinetteria Bresciane Bonomi TURBO PRESS GAS	TH 16*	570460	
		TH 20*	570470	
		TH 26*	570475	
		TH 32	570480	
TH 32		570480		
Sa.MI plastic	TH 14*	570455		
	TH 16*	570460		
	TH 18*	570465		
	TH 20*	570470		
	TH 26*	570475		
	TH 32	570480		
	TH 40	570485		
	TH 50 (S)	572400		
	TH 63 (S)	572405		
	Sa.MI plastic Multistrato Gas	TH 16*	570460	
		TH 20*	570470	
		TH 26*	570475	
		TH 32	570480	
TH 32		570480		
SANHA 3fit-Press Pb-free Serie 25000	B 16*	570850		
	B 20*	570860		
	B 26	570870		
	B 32	570880		
	F 16*	570715		
	F 20*	570725		
	F 26*	570730		
	F 32	570735		
	F 40	570742		
	F 50	570745		
	F 63 (S)	572385		
	H 16*	570320		
	H 20*	570350		
H 26*	570370			
H 32	570380			
H 40 (4G)	570390			
TH 16*	570460			
TH 20*	570470			
TH 26*	570475			
TH 32	570480			
TH 40	570485			
TH 50 (S)	572400			
TH 63 (S)	572405			
U 16*	570765			
U 20*	570775			
U 32	570785			
U 40	570790			
U 50	570795			
U 63 (PR-3B) ³⁾	572837			
U 63 (S)	572365			
SANHA 3fit-Press PPSU Serie 35000	B 16*	570850		
	B 20*	570860		
	B 26	570870		
	B 32	570880		
	F 16*	570715		
	F 20*	570725		
	F 26*	570730		
	F 32	570735		
	F 40	570742		
	F 50	570745		
	F 63 (S)	572385		
	H 16*	570320		
	H 20*	570350		
H 26*	570370			
H 32	570380			
TH 16*	570460			
TH 20*	570470			
TH 26*	570475			
TH 32	570480			
TH 40	570485			
TH 50 (S)	572400			
TH 63 (S)	572405			
U 16*	570765			
U 20*	570775			
U 32	570785			
SANHA-NiroSan Gas Presssystem Serie 17000	SA 15	570935		
	SA 18	570940		
	SA 22	570945		
	SA 28	570950		
	SA 35	570955		
	M 15	570110		
	M 18	570120		
	M 22	570130		
	M 28	570140		
	M 35	570150		
	M 42 (PR-3S) ³⁾	572706		
	M 54 (PR-3S) ³⁾	572708		
	M 15 45° (PR-2B) ³⁾	574522		
M 18 45° (PR-2B) ³⁾	574524			
M 22 45° (PR-2B) ³⁾	574526			
M 28 45° (PR-2B) ³⁾	574528			
M 35 45° (PR-2B) ³⁾	574530			
V 15	570115			
V 18	570125			

REMS pressing tongs REMS pressing rings

Accessories for REMS radial presses (except for REMS Mini-Press ACC, REMS Mini-Press 22 V ACC) and suitable radial presses of other makes

System	Pressing contour	Art.-No.	System	Pressing contour	Art.-No.	System	Pressing contour	Art.-No.			
SANHA-NiroSan Industry Presssystem Serie 18000	SA 15	570935	SANHA NiroTherm Serie 91000	SA 15	570935	SANHA-Press GAS Pressfittings Serie 10000/ Serie 11000	SA 12	570930			
	SA 18	570940		SA 18	570940		SA 14	570932			
	SA 22	570945		SA 22	570945		SA 15	570935			
	SA 28	570950		SA 28	570950		SA 16	570937			
	SA 35	570955		SA 35	570955		SA 18	570940			
	M 15	570110		M 15	570110		SA 22	570945			
	M 18	570120		M 18	570120		SA 28	570950			
	M 22	570130		M 22	570130		SA 35	570955			
	M 28	570140		M 28	570140		M 12	570100			
	M 35	570150		M 35	570150		M 15	570110			
	M 42 (PR-3S) ³⁾	572706		M 42 (PR-3S) ³⁾	572706		M 18	570120			
	M 54 (PR-3S) ³⁾	572708		M 54 (PR-3S) ³⁾	572708		M 22	570130			
	M 15 45° (PR-2B) ³⁾	574522		M 15 45° (PR-2B) ³⁾	574522		M 28	570140			
	M 18 45° (PR-2B) ³⁾	574524		M 18 45° (PR-2B) ³⁾	574524		M 35	570150			
	M 22 45° (PR-2B) ³⁾	574526		M 22 45° (PR-2B) ³⁾	574526		M 42 (PR-3S) ³⁾	572706			
	M 28 45° (PR-2B) ³⁾	574528		M 28 45° (PR-2B) ³⁾	574528		M 54 (PR-3S) ³⁾	572708			
	M 35 45° (PR-2B) ³⁾	574530		M 35 45° (PR-2B) ³⁾	574530		M 12 45° (PR-2B) ³⁾	574520			
	V 15	570115		V 15	570115		M 15 45° (PR-2B) ³⁾	574522			
	V 18	570125		V 18	570125		M 18 45° (PR-2B) ³⁾	574524			
	V 22	570135		V 22	570135		M 22 45° (PR-2B) ³⁾	574526			
	V 28	570145		V 28	570145		M 28 45° (PR-2B) ³⁾	574528			
	V 35	570155		V 35	570155		M 35 45° (PR-2B) ³⁾	574530			
	V 42	570165		V 42	570165		V 12	570107			
	V 54	570175		V 54	570175		V 14	570112			
	V 15 45° (PR-2B) ³⁾	574504		V 15 45° (PR-2B) ³⁾	574504		VG 14	570132			
	V 18 45° (PR-2B) ³⁾	574506		V 18 45° (PR-2B) ³⁾	574506		V 15	570115			
	V 22 45° (PR-2B) ³⁾	574508		V 22 45° (PR-2B) ³⁾	574508		V 16	570117			
	V 28 45° (PR-2B) ³⁾	574510		V 28 45° (PR-2B) ³⁾	574510		VG 16	570137			
	V 35 45° (PR-2B) ³⁾	574512		V 35 45° (PR-2B) ³⁾	574512		V 18	570125			
	SANHA-NiroSan-Presssystem Serie 9000	SA 15		570935	SANHA NiroTherm Industry Serie 98000		SA 15	570935	SANHA-Press Pressfittings Serie 6000	SA 12	570930
		SA 18		570940			SA 18	570940		SA 14	570932
		SA 22		570945			SA 22	570945		SA 15	570935
		SA 28		570950			SA 28	570950		SA 16	570937
		SA 35		570955			SA 35	570955		SA 18	570940
M 15		570110	M 15	570110		SA 22	570945				
M 18		570120	M 18	570120		SA 28	570950				
M 22		570130	M 22	570130		SA 35	570955				
M 28		570140	M 28	570140		M 12	570100				
M 35		570150	M 35	570150		M 15	570110				
M 42 (PR-3S) ³⁾		572706	M 42 (PR-3S) ³⁾	572706		M 18	570120				
M 54 (PR-3S) ³⁾		572708	M 54 (PR-3S) ³⁾	572708		M 22	570130				
M 15 45° (PR-2B) ³⁾		574522	M 15 45° (PR-2B) ³⁾	574522		M 28	570140				
M 18 45° (PR-2B) ³⁾		574524	M 18 45° (PR-2B) ³⁾	574524		M 35	570150				
M 22 45° (PR-2B) ³⁾		574526	M 22 45° (PR-2B) ³⁾	574526		M 42 (PR-3S) ³⁾	572706				
M 28 45° (PR-2B) ³⁾		574528	M 28 45° (PR-2B) ³⁾	574528		M 54 (PR-3S) ³⁾	572708				
M 35 45° (PR-2B) ³⁾		574530	M 35 45° (PR-2B) ³⁾	574530		M 12 45° (PR-2B) ³⁾	574520				
V 15		570115	V 15	570115		M 15 45° (PR-2B) ³⁾	574522				
V 18		570125	V 18	570125		M 18 45° (PR-2B) ³⁾	574524				
V 22		570135	V 22	570135		M 22 45° (PR-2B) ³⁾	574526				
V 28		570145	V 28	570145		M 28 45° (PR-2B) ³⁾	574528				
V 35		570155	V 35	570155		M 35 45° (PR-2B) ³⁾	574530				
V 42		570165	V 42	570165		V 12	570107				
V 54		570175	V 54	570175		V 14	570112				
V 15 45° (PR-2B) ³⁾		574504	V 15 45° (PR-2B) ³⁾	574504		VG 14	570132				
V 18 45° (PR-2B) ³⁾		574506	V 18 45° (PR-2B) ³⁾	574506		V 15	570115				
V 22 45° (PR-2B) ³⁾		574508	V 22 45° (PR-2B) ³⁾	574508		V 16	570117				
V 28 45° (PR-2B) ³⁾		574510	V 28 45° (PR-2B) ³⁾	574510		VG 16	570137				
V 35 45° (PR-2B) ³⁾		574512	V 35 45° (PR-2B) ³⁾	574512		V 18	570125				
SANHA-NiroSan SF Presssystem Serie 19000 (silicone free)		SA 15	570935	SANHA-Press Chrom Serie 16000		SA 12	570930	SANHA-Press Pressfittings Serie 6000		SA 14	570932
		SA 18	570940			SA 15	570935			SA 15	570935
		SA 22	570945			SA 18	570940			SA 16	570937
		SA 28	570950			SA 22	570945			SA 18	570940
		SA 35	570955			SA 28	570950			SA 22	570945
	M 15	570110	SA 35		570955	SA 28	570950				
	M 18	570120	M 12		570100	SA 35	570955				
	M 22	570130	M 15		570110	M 12	570100				
	M 28	570140	M 18		570120	M 15	570110				
	M 35	570150	M 22		570130	M 18	570120				
	M 42 (PR-3S) ³⁾	572706	M 28		570140	M 22	570130				
	M 54 (PR-3S) ³⁾	572708	M 35		570150	M 28	570140				
	M 15 45° (PR-2B) ³⁾	574522	M 42 (PR-3S) ³⁾		572706	M 35	570150				
	M 18 45° (PR-2B) ³⁾	574524	M 54 (PR-3S) ³⁾		572708	M 42 (PR-3S) ³⁾	572706				
	M 22 45° (PR-2B) ³⁾	574526	M 12 45° (PR-2B) ³⁾		574520	M 54 (PR-3S) ³⁾	572708				
	M 28 45° (PR-2B) ³⁾	574528	M 15 45° (PR-2B) ³⁾		574522	M 12 45° (PR-2B) ³⁾	574520				
	M 35 45° (PR-2B) ³⁾	574530	M 18 45° (PR-2B) ³⁾		574524	M 15 45° (PR-2B) ³⁾	574522				
	V 15	570115	M 22 45° (PR-2B) ³⁾		574526	M 18 45° (PR-2B) ³⁾	574524				
	V 18	570125	M 28 45° (PR-2B) ³⁾		574528	M 22 45° (PR-2B) ³⁾	574526				
	V 22	570135	V 12		570107	M 28 45° (PR-2B) ³⁾	574528				
	V 28	570145	V 15		570115	M 35 45° (PR-2B) ³⁾	574530				
	V 35	570155	V 18		570125	V 12	570107				
	V 42	570165	V 22		570135	V 14	570112				
	V 54	570175	V 28		570145	VG 14	570132				
	V 15 45° (PR-2B) ³⁾	574504	V 35		570155	V 15	570115				
	V 18 45° (PR-2B) ³⁾	574506	V 42		570165	V 16	570117				
	V 22 45° (PR-2B) ³⁾	574508	V 54		570175	VG 16	570137				
	V 28 45° (PR-2B) ³⁾	574510	V 12 45° (PR-2B) ³⁾		574502	V 18	570125				
	V 35 45° (PR-2B) ³⁾	574512	V 15 45° (PR-2B) ³⁾		574504	V 22	570135				
			V 18 45° (PR-2B) ³⁾		574506	V 28	570145				
			V 22 45° (PR-2B) ³⁾		574508	V 35	570155				
			V 28 45° (PR-2B) ³⁾		574510	V 42	570165				
			V 35 45° (PR-2B) ³⁾		574512	V 54	570175				
						V 12 45° (PR-2B) ³⁾	574502				
				VG 14 45° (PR-2B) ³⁾	574536						
				V 15 45° (PR-2B) ³⁾	574504						
				VG 16 45° (PR-2B) ³⁾	574538						
				V 18 45° (PR-2B) ³⁾	574506						
				V 22 45° (PR-2B) ³⁾	574508						
				V 28 45° (PR-2B) ³⁾	574510						
				V 35 45° (PR-2B) ³⁾	574512						

Pressfitting systems for gas installations must only be pressed with pressing tongs/pressing rings which are highlighted in yellow.

Observe the national regulations.

* These pressing tongs also fit the manual radial press REMS Eco-Press. Observe the national regulations.

- Only pressing tongs from designation "108" (1st quarter of 2008), "208" (2nd quarter of 2008) etc. can be used. The designation is stamped on every pressing jaw.
- For this pressfitting system producing a pressing joint with manual radial presses is not permitted.
- Adapter tongs are required for driving pressing rings (PR), see page 160.
- Press fittings made of red bronze (ProPress XL) must be pressed with pressing rings with press contour VUSR, copper fittings (ProPress XL-C) and stainless steel fittings (ProPress XL-S) with pressing rings with press contour VUSF.
- For taking suitable pressing inserts.
- Press fittings made of red bronze (Sanpress XL) must be pressed with pressing rings with press contour VR, copper fittings (Profipress XL, Profipress G XL), carbon steel (Prestabo XL) and stainless steel fittings (Sanpress Inox XL, Sanpress Inox G XL) with pressing rings with press contour VF.
- Driven by REMS Power-Press XL.

The suitability of REMS pressing tools for pressfitting systems: Date 09.10.2015. For the updated situation regarding suitability status check our website:

www.rems.de → Downloads → Product catalogues, brochures → REMS Catalogue.

Pressing tongs/pressing rings for additional pressfitting systems on request.

REMS pressing tongs

REMS pressing rings

Accessories for REMS radial presses (except for REMS Mini-Press ACC, REMS Mini-Press 22 V ACC) and suitable radial presses of other makes

System	Pressing contour	Art.-No.
SANHA-Press SOLAR Pressfittings Serie 12000/ Serie 13000	SA 12	570930
	SA 15	570935
	SA 18	570940
	SA 22	570945
	SA 28	570950
	SA 35	570955
	M 12	570100
	M 15	570110
	M 18	570120
	M 22	570130
	M 28	570140
	M 35	570150
	M 42 (PR-3S) ³⁾	572706
	M 54 (PR-3S) ³⁾	572708
	M 12 45° (PR-2B) ³⁾	574520
	M 15 45° (PR-2B) ³⁾	574522
	M 18 45° (PR-2B) ³⁾	574524
	M 22 45° (PR-2B) ³⁾	574526
	M 28 45° (PR-2B) ³⁾	574528
	M 35 45° (PR-2B) ³⁾	574530
	V 12	570107
	V 15	570115
	V 18	570125
	V 22	570135
	V 28	570145
	V 35	570155
	V 42	570165
	V 54	570175
	V 12 45° (PR-2B) ³⁾	574502
	V 15 45° (PR-2B) ³⁾	574504
	V 18 45° (PR-2B) ³⁾	574506
	V 22 45° (PR-2B) ³⁾	574508
	V 28 45° (PR-2B) ³⁾	574510
	V 35 45° (PR-2B) ³⁾	574512
SANHA PURAPRESS Serie 8000	SA 12	570930
	SA 14	570932
	SA 15	570935
	SA 16	570937
	SA 18	570940
	SA 22	570945
	SA 28	570950
	SA 35	570955
	M 12	570100
	M 15 ¹⁾	570110
	M 18 ¹⁾	570120
	M 22 ¹⁾	570130
	M 28 ¹⁾	570140
	M 35 ¹⁾	570150
	M 42 (PR-3S) ³⁾	572706
	M 54 (PR-3S) ³⁾	572708
	M 12 45° (PR-2B) ³⁾	574520
	M 15 45° (PR-2B) ³⁾	574522
	M 18 45° (PR-2B) ³⁾	574524
	M 22 45° (PR-2B) ³⁾	574526
	M 28 45° (PR-2B) ³⁾	574528
	M 35 45° (PR-2B) ³⁾	574530
	V 12	570107
	V 14	570112
	VG 14	570132
	V 15	570115
	V 16	570117
	VG 16	570137
	V 18	570125
	V 22	570135
	V 28	570145
	V 35	570155
	V 42	570165
	V 54	570175
V 12 45° (PR-2B) ³⁾	574502	
VG 14 45° (PR-2B) ³⁾	574536	
V 15 45° (PR-2B) ³⁾	574504	
VG 16 45° (PR-2B) ³⁾	574538	
V 18 45° (PR-2B) ³⁾	574506	
V 22 45° (PR-2B) ³⁾	574508	
V 28 45° (PR-2B) ³⁾	574510	
V 35 45° (PR-2B) ³⁾	574512	
SANHA-Therm Serie 24000	SA 12	570930
	SA 15	570935
	SA 18	570940
	SA 22	570945
	SA 28	570950
	SA 35	570955
	M 12	570100
	M 15	570110
	M 18	570120
	M 22	570130
	M 28	570140
	M 35	570150
	M 42 (PR-3S) ³⁾	572706
	M 54 (PR-3S) ³⁾	572708
	M 12 45° (PR-2B) ³⁾	574520
	M 15 45° (PR-2B) ³⁾	574522
	M 18 45° (PR-2B) ³⁾	574524
	M 22 45° (PR-2B) ³⁾	574526
	M 28 45° (PR-2B) ³⁾	574528
	M 35 45° (PR-2B) ³⁾	574530
	V 12	570107
	V 15	570115
	V 18	570125
	V 22	570135
	V 28	570145
	V 35	570155
	V 42	570165
	V 54	570175
	V 12 45° (PR-2B) ³⁾	574502
	V 15 45° (PR-2B) ³⁾	574504
	V 18 45° (PR-2B) ³⁾	574506
	V 22 45° (PR-2B) ³⁾	574508
	V 28 45° (PR-2B) ³⁾	574510
	V 35 45° (PR-2B) ³⁾	574512

System	Pressing contour	Art.-No.	
SANHA-Therm Industry Serie 28000	SA 12	570930	
	SA 15	570935	
	SA 18	570940	
	SA 22	570945	
	SA 28	570950	
	SA 35	570955	
	M 12	570100	
	M 15	570110	
	M 18	570120	
	M 22	570130	
	M 28	570140	
	M 35	570150	
	M 42 (PR-3S) ³⁾	572706	
	M 54 (PR-3S) ³⁾	572708	
	M 12 45° (PR-2B) ³⁾	574520	
	M 15 45° (PR-2B) ³⁾	574522	
	M 18 45° (PR-2B) ³⁾	574524	
	M 22 45° (PR-2B) ³⁾	574526	
	M 28 45° (PR-2B) ³⁾	574528	
	M 35 45° (PR-2B) ³⁾	574530	
	V 12	570107	
	V 15	570115	
	V 18	570125	
	V 22	570135	
	V 28	570145	
	V 35	570155	
	V 42	570165	
	V 54	570175	
	V 12 45° (PR-2B) ³⁾	574502	
	V 15 45° (PR-2B) ³⁾	574504	
	V 18 45° (PR-2B) ³⁾	574506	
	V 22 45° (PR-2B) ³⁾	574508	
	V 28 45° (PR-2B) ³⁾	574510	
	V 35 45° (PR-2B) ³⁾	574512	
SATEC SK VI Term	TH 16*	570460	
	TH 18*	570465	
	TH 20*	570470	
	TH 26*	570475	
	TH 32	570480	
	U 40	570790	
	U 50	570795	
	U 63 (S)	572365	
	Schwer Fittings AQUApress	M 12	570100
		M 15	570110
		M 18	570120
		M 22	570130
M 28		570140	
M 35		570150	
M 42 (4G)		570160	
M 54 (4G)		570170	
M 12 45° (PR-2B) ³⁾		574520	
M 15 45° (PR-2B) ³⁾		574522	
M 18 45° (PR-2B) ³⁾		574524	
M 22 45° (PR-2B) ³⁾		574526	
M 28 45° (PR-2B) ³⁾	574528		
M 35 45° (PR-2B) ³⁾	574530		
Seppelfricke VSH SudoPress C-Stahl Visu-Control	V 12	570107	
	V 15	570115	
	V 18	570125	
	V 22	570135	
	V 28	570145	
	V 35	570155	
	V 42	570165	
	V 54	570175	
	V 15	570115	
	V 18	570125	
	V 22	570135	
	V 28	570145	
V 35	570155		
V 42	570165		
V 54	570175		
Seppelfricke VSH SudoPress Edelstahl Visu-Control	V 15	570115	
	V 18	570125	
	V 22	570135	
	V 28	570145	
	V 35	570155	
	V 42	570165	
	V 54	570175	
	V 12	570107	
	V 15	570115	
	V 18	570125	
	V 22	570135	
	V 28	570145	
V 35	570155		
V 42	570165		
V 54	570175		
Seppelfricke VSH SudoPress Kupfer Visu-Control	V 15	570115	
	V 18	570125	
	V 22	570135	
	V 28	570145	
	V 35	570155	
	V 42	570165	
	V 54	570175	
	V 12	570107	
	V 15	570115	
	V 18	570125	
	V 22	570135	
	V 28	570145	
V 35	570155		
V 42	570165		
V 54	570175		
Seppelfricke VSH SudoPress Kupfer Solar Visu-Control	V 15	570115	
	V 18	570125	
	V 22	570135	
	TH 14*	570455	
	TH 16*	570460	
	TH 18*	570465	
	TH 20*	570470	
	TH 26*	570475	
	THL 32	570487	
	TH 40	570485	
	TH 50 (S)	572400	
	TH 63 (S)	572405	

System	Pressing contour	Art.-No.	
Seppelfricke VSH XPress C-Stahl	M 12	570100	
	M 15	570110	
	M 18 ¹⁾	570120	
	M 22	570130	
	M 28 ¹⁾	570140	
	M 35	570150	
	M 42 (4G)	570160	
	M 54 (4G)	570170	
	M 42 (PR-3S) ³⁾	572706	
	M 54 (PR-3S) ³⁾	572708	
	M 12 45° (PR-2B) ³⁾	574520	
	M 15 45° (PR-2B) ³⁾	574522	
	M 18 45° (PR-2B) ³⁾	574524	
	M 22 45° (PR-2B) ³⁾	574526	
	M 28 45° (PR-2B) ³⁾	574528	
	M 35 45° (PR-2B) ³⁾	574530	
	Seppelfricke VSH XPress Edelstahl	M 15	570110
		M 18 ¹⁾	570120
		M 22	570130
		M 28 ¹⁾	570140
		M 35	570150
		M 42 (4G)	570160
		M 54 (4G)	570170
		M 42 (PR-3S) ³⁾	572706
		M 54 (PR-3S) ³⁾	572708
		M 15 45° (PR-2B) ³⁾	574522
		M 18 45° (PR-2B) ³⁾	574524
		M 22 45° (PR-2B) ³⁾	574526
	M 28 45° (PR-2B) ³⁾	574528	
	M 35 45° (PR-2B) ³⁾	574530	
	Seppelfricke VSH XPress Edelstahl Gas	M 15	570110
		M 18 ¹⁾	570120
		M 22	570130
		M 28 ¹⁾	570140
M 35		570150	
M 42 (PR-3S) ³⁾		572706	
M 54 (PR-3S) ³⁾		572708	
M 15 45° (PR-2B) ³⁾		574522	
M 18 45° (PR-2B) ³⁾		574524	
M 22 45° (PR-2B) ³⁾		574526	
M 28 45° (PR-2B) ³⁾		574528	
M 35 45° (PR-2B) ³⁾		574530	
Seppelfricke VSH XPress Kupfer	M 12	570100	
	M 15	570110	
	M 18 ¹⁾	570120	
	M 22	570130	
	M 28 ¹⁾	570140	
	M 35	570150	
	M 42 (PR-3S) ³⁾	572706	
	M 54 (PR-3S) ³⁾	572708	
	M 12 45° (PR-2B) ³⁾	574520	
	M 15 45° (PR-2B) ³⁾	574522	
	M 18 45° (PR-2B) ³⁾	574524	
	M 22 45° (PR-2B) ³⁾	574526	
M 28 45° (PR-2B) ³⁾	574528		
M 35 45° (PR-2B) ³⁾	574530		
Seppelfricke VSH XPress Kupfer Gas	M 15	570110	
	M 18 ¹⁾	570120	
	M 22	570130	
	M 28 ¹⁾	570140	
	M 35	570150	
	M 42 (PR-3S) ³⁾	572706	
	M 54 (PR-3S) ³⁾	572708	
	M 12 45° (PR-2B) ³⁾	574520	
	M 15 45° (PR-2B) ³⁾	574522	
	M 18 45° (PR-2B) ³⁾	574524	
	M 22 45° (PR-2B) ³⁾	574526	
	M 28 45° (PR-2B) ³⁾	574528	
M 35 45° (PR-2B) ³⁾	574530		
SESTA SESTA GAS	TH 14*	570455	
	TH 16*	570460	
	TH 20*	570470	
	TH 26*	570475	
	TH 32	570480	
	SESTA Sistema multistrato	H 16*	570320
H 20*		570350	
TH 14*		570455	
TH 16*		570460	
TH 18*		570465	
TH 20*		570470	
TH 26*		570475	
TH 32		570480	
TH 40		570485	
TH 50 (S)		572400	
TH 63 (S)		572405	
U 16*		570765	
U 20*	570775		
SLOVARM PEX-THERM	U 16*	570765	
	U 20*	570775	
	H 26*	570370	
	U 32	570785	
	H 16*	570320	
	H 20*	570350	
SOMATHERM MULTIX	H 26*	570370	
	H 32	570380	
	TH 16*	570460	
	TH 20*	570470	
	TH 26*	570475	
	TH 32	570480	
	U 16*	570765	
	U 20*	570775	
	U 32	570785	

REMS pressing tongs REMS pressing rings

Accessories for REMS radial presses (except for REMS Mini-Press ACC, REMS Mini-Press 22 V ACC) and suitable radial presses of other makes

System	Pressing contour	Art.-No.	
SOMATHERM SomaPRESS	H 12*	570300	
	H 16*	570320	
	H 20*	570350	
	H 25*	570360	
	RFz 12*	571320	
	RFz 16*	571325	
	RFz 20*	571330	
	RFz 25	571335	
	U 16*	570765	
	U 20*	570775	
	U 25*	570780	
	STANDARD HIDRAULICA MultiStandard	U 16*	570765
		U 18*	570770
		U 20*	570775
U 25*		570780	
U 32		570785	
U 40		570790	
STELBI Polikraft	U 50	570795	
	U 63 (PR-3B) ³⁾	572837	
	U 63 (S)	572365	
	H 16*	570320	
	H 20*	570350	
	H 26*	570370	
	TH 16*	570460	
	TH 20*	570470	
	TH 26*	570475	
	TH 32	570480	
STELBI Stelgas	TH 40	570485	
	TH 50 (S)	572400	
	TH 63 (S)	572405	
	U 16*	570765	
	U 20*	570775	
	TH 16*	570460	
	TH 20*	570470	
	TH 26*	570475	
	SURE HISPANIA SURE-PRESS	RFz 16*	571325
		RFz 20*	571330
RFz 25		571337	
RFz 32		571342	
U 40		570790	
U 50		570795	
U 63 (PR-3B) ³⁾		572837	
U 63 (S)		572365	
System WELCO-Gas	H 16 A*	570620	
	H 20 A*	570650	
	H 26 A*	570670	
	H 32 A*	570680	
System WELCO-Flex	H 14 A*	570610	
	H 16 A*	570620	
	H 17 A*	570630	
	H 20 A*	570650	
	H 26 A*	570670	
	H 32 A	570680	
System WELCO-Teck	H 40 A (4G)	570695	
	H 16 A*	570620	
	H 20 A*	570650	
	H 26 A*	570670	
TDM BRASS Serie 1600	H 16*	570320	
	H 18*	570340	
	H 20*	570350	
	H 26*	570370	
	H 32	570380	
	TH 16*	570460	
	TH 18*	570465	
	TH 20*	570470	
	TH 26*	570475	
	THL 32	570487	
	U 16*	570765	
	U 18*	570770	
	U 20*	570775	
	C 26*	570750	
	U 32	570785	
	TDM BRASS Serie 1700 (Gas)	TH 16*	570460
TH 20*		570470	
TH 26*		570475	
THL 32		570487	

System	Pressing contour	Art.-No.	
TERMICALINE Termipex	B 16*	570850	
	B 20*	570860	
	B 26	570870	
	B 32	570880	
	H 16*	570320	
	H 20*	570350	
	TH 16*	570460	
	TH 20*	570470	
	TH 26*	570475	
	TH 32	570480	
	U 16*	570765	
	U 20*	570775	
	TermoConcept TC-PRESS	Basic E01 ⁵⁾	571855
THERMOLUTZ	H 14*	570310	
	H 16*	570320	
	H 17*	570330	
	TH 20*	570470	
	TE-SA TE-SA press serie 800	TH 14*	570455
TH 16*		570460	
TH 18*		570465	
TH 20*		570470	
TH 26*		570475	
TH 32		570480	
TH 40		570485	
TH 50 (S)		572400	
TH 63 (S)		572405	
TIEMME AL-COBRAPEX Serie 1650		TH 14*	570455
	TH 16*	570460	
	TH 18*	570465	
	TH 20*	570470	
	TH 25*	570495	
	TH 26*	570475	
	THL 32	570487	
	TH 40	570485	
	TH 50 (S)	572400	
	TH 63 (S)	572405	
TIEMME Serie 1700 PE-X a pressare	RFz 12*	571320	
	RFz 16*	571325	
	RFz 20*	571330	
	RFz 25	571335	
	RFz 32	571340	
TIEMME TIEMME Gas	TH 16*	570460	
	TH 20*	570470	
	TH 26*	570475	
TIEMME THL 32	570487		
TIGRE ALPEX GÁS	TH 16*	570460	
	TH 20*	570470	
	TH 26*	570475	
TKM Systemtechnik	TH 32	570480	
	TH 40	570485	
	TH 50 (S)	572400	
	TH 63 (S)	572405	
	U 16*	570765	
	U 18*	570770	
	U 20*	570775	
	U 25*	570780	
TRA MULTITRAPRESS	U 32	570785	
	U 40	570790	
	U 50	570795	
	U 63 (PR-3B) ³⁾	572837	
	U 63 (S)	572365	
	U 16*	570765	
	U 18*	570770	
	U 20*	570775	
	U 25*	570780	
	U 32	570785	
TRA TRAPRESS	U 40	570790	
	U 50	570795	
	U 63 (PR-3B) ³⁾	572837	
	U 63 (S)	572365	
	H 12*	570300	
	H 16*	570320	
	H 20*	570350	
	H 25*	570360	
	H 32	570380	
	RFz 12*	571320	
	RFz 16*	571325	
	RFz 20*	571330	
	RFz 25	571335	
	RFz 32	571340	
	TWEETOP	U 16*	570765
		U 20*	570775
U 25*		570780	
U 32		570785	
U 40		570790	
U 50		570795	
U 63 (PR-3B) ³⁾		572837	
U 63 (S)		572365	
U 75 (PR-3B) ³⁾	572828		

System	Pressing contour	Art.-No.
UNICAL AG MAX-MULTIPEX	U 16*	570765
	U 20*	570775
	H 26*	570370
	U 32	570785
	UNIDELTA DeltAll	TH 16*
TH 20*		570470
TH 26*		570475
TH 32		570480
TH 40		570485
TH 50 (S)		572400
TH 63 (S)		572405
H 16*		570320
H 20*		570350
H 26*		570370
UNIDELTA DeltAll GAS	H 32	570380
	H 40 (4G)	570390
	U 16*	570765
	U 20*	570775
	U 32	570785
	U 40	570790
	U 50	570795
	U 63 (S)	572365
	TH 16*	570460
	TH 20*	570470
Uponor MLC	TH 26*	570475
	TH 32	570480
	H 16*	570320
	H 20*	570350
	H 26*	570370
	H 32	570380
	U 16*	570765
	U 20*	570775
	U 32	570785
	UP 14*	572630
Uponor MLC-D	UP 16*	572632
	UP 18*	572634
	UP 20*	572636
	UP 25	572638
	UP 32	572640
	U 40	570790
	U 50	570795
	U 63 (PR-3B) ³⁾	572837
	U 63 (S)	572365
	U 75 (PR-3B) ³⁾	572828
Uponor MLC-G ²⁾	UP 16*	572632
	UP 20*	572636
	UP 25	572638
	UP 32	572640
	U 63 (PR-3B) ³⁾	572837
Uponor Uni Pipe PLUS	U 63 (S)	572365
	U 75 (PR-3B) ³⁾	572828
	UP 16*	572632
	UP 20*	572636
Valsir PEXAL	UP 25	572638
	UP 32	572640
	H 14*	570310
	H 16*	570320
	H 20*	570350
	H 26*	570370
	H 32 V	570685
	H 40 V (PR-3B) ³⁾	572833
	H 50 V (PR-3B) ³⁾	572834
	H 63 V (PR-3B) ³⁾	572835
Valsir PEXAL Gas	H 14*	570310
	H 16*	570320
	H 20*	570350
	H 26*	570370
	Van Marcke Log. Tu-Bi-Pex	TH 16*
TH 17*		570462
TH 20*		570470
TH 26*		570475
TH 32		570480
TH 40		570485
TH 50 (S)		572400
TH 63 (S)	572405	
TH 75 (PR-3B) ³⁾	572829	

Pressfitting systems for gas installations must only be pressed with pressing tongs/pressing rings which are highlighted in yellow. Observe the national regulations.

* These pressing tongs also fit the manual radial press REMS Eco-Press. Observe the national regulations.

¹⁾ Only pressing tongs from designation "108" (1st quarter of 2008), "208" (2nd quarter of 2008) etc. can be used. The designation is stamped on every pressing jaw.

²⁾ For this pressfitting system producing a pressing joint with manual radial presses is not permitted.

³⁾ Adapter tongs are required for driving pressing rings (PR), see page 160.

⁴⁾ Press fittings made of red bronze (ProPress XL) must be pressed with pressing rings with press contour VUSR, copper fittings (ProPress XL-C) and stainless steel fittings (ProPress XL-S) with pressing rings with press contour VUSF.

⁵⁾ For taking suitable pressing inserts.

⁶⁾ Press fittings made of red bronze (Sanpress XL) must be pressed with pressing rings with press contour VR, copper fittings (Profipress XL, Profipress G XL), carbon steel (Prestabo XL) and stainless steel fittings (Sanpress Inox XL, Sanpress Inox G XL) with pressing rings with press contour VF.

⁷⁾ Driven by REMS Power-Press XL.

The suitability of REMS pressing tools for pressfitting systems: Date 09.10.2015. For the updated situation regarding suitability status check our website: www.rems.de → Downloads → Product catalogues, brochures → REMS Catalogue.

Pressing tongs/pressing rings for additional pressfitting systems on request.

REMS pressing tongs REMS pressing rings

Accessories for REMS radial presses (except for REMS Mini-Press ACC, REMS Mini-Press 22 V ACC) and suitable radial presses of other makes

System	Pressing contour	Art.-No.	
Van Marcke Log. Tu-Bi-Press	M 12	570100	
	M 15	570110	
	M 18	570120	
	M 22	570130	
	M 28	570140	
	M 35	570150	
	M 42 (4G)	570160	
	M 54 (4G)	570170	
	M 42 (PR-3S) ³⁾	572706	
	M 54 (PR-3S) ³⁾	572708	
	M 12 45° (PR-2B) ³⁾	574520	
	M 15 45° (PR-2B) ³⁾	574522	
	M 18 45° (PR-2B) ³⁾	574524	
	M 22 45° (PR-2B) ³⁾	574526	
	M 28 45° (PR-2B) ³⁾	574528	
	M 35 45° (PR-2B) ³⁾	574530	
	Variotherm System TH	TH 11,6*	570482
TH 16*		570460	
TH 20*		570470	
Viega Fonterra	VX 12*	571630	
	VP 14/15*	570905	
	VP 16/17*	570910	
	VP 20*	570915	
Viega Pexfit	VP 25*	570920	
	VX 16*	571635	
	VX 20*	571640	
	VX 25*	571645	
Viega Pexfit G	VX 16*	571635	
	VX 20*	571640	
	VX 25*	571645	
	Viega Prestabo	V 12	570107
V 15		570115	
V 18		570125	
V 22		570135	
V 28		570145	
V 35		570155	
V 42		570165	
V 54		570175	
VF 64,0 (PR-3B) ^{3) 6)}		572815	
VF 76,1 (PR-3B) ^{3) 6)}		572816	
VF 88,9 (PR-3B) ^{3) 6)}		572817	
VF 108,0 (PR-3B) ^{3) 6)}		572818	
V 12 45° (PR-2B) ³⁾		574502	
V 15 45° (PR-2B) ³⁾		574504	
V 18 45° (PR-2B) ³⁾		574506	
V 22 45° (PR-2B) ³⁾		574508	
V 28 45° (PR-2B) ³⁾		574510	
V 35 45° (PR-2B) ³⁾	574512		
Viega Profipress	V 12	570107	
	VG 14	570132	
	V 15	570115	
	VG 16	570137	
	V 18	570125	
	V 22	570135	
	V 28	570145	
	V 35	570155	
	V 42	570165	
	V 54	570175	
	VF 64,0 (PR-3B) ^{3) 6)}	572815	
	VF 76,1 (PR-3B) ^{3) 6)}	572816	
	VF 88,9 (PR-3B) ^{3) 6)}	572817	
	VF 108,0 (PR-3B) ^{3) 6)}	572818	
	V 12 45° (PR-2B) ³⁾	574502	
	VG 14 45° (PR-2B) ³⁾	574536	
	V 15 45° (PR-2B) ³⁾	574504	
VG 16 45° (PR-2B) ³⁾	574538		
V 18 45° (PR-2B) ³⁾	574506		
V 22 45° (PR-2B) ³⁾	574508		
V 28 45° (PR-2B) ³⁾	574510		
V 35 45° (PR-2B) ³⁾	574512		
Viega Profipress G	V 12	570107	
	V 15	570115	
	V 18	570125	
	V 22	570135	
	V 28	570145	
	V 35	570155	
	V 42	570165	
	V 54	570175	
	VF 64,0 (PR-3B) ^{3) 6)}	572815	
	V 12 45° (PR-2B) ³⁾	574502	
	V 15 45° (PR-2B) ³⁾	574504	
	V 18 45° (PR-2B) ³⁾	574506	
	V 22 45° (PR-2B) ³⁾	574508	
	V 28 45° (PR-2B) ³⁾	574510	
	V 35 45° (PR-2B) ³⁾	574512	
	Viega Profipress S	V 12	570107
		V 15	570115
V 18		570125	
V 22		570135	
V 28		570145	
V 35		570155	
V 12 45° (PR-2B) ³⁾		574502	
V 15 45° (PR-2B) ³⁾		574504	
V 18 45° (PR-2B) ³⁾		574506	
V 22 45° (PR-2B) ³⁾		574508	
Viega Profipress Therm	V 28 45° (PR-2B) ³⁾	574510	
	V 35 45° (PR-2B) ³⁾	574512	
	V 12	570107	
	V 15	570115	
	V 18	570125	
	V 22	570135	
	V 12 45° (PR-2B) ³⁾	574502	
	V 15 45° (PR-2B) ³⁾	574504	
	V 18 45° (PR-2B) ³⁾	574506	
	V 22 45° (PR-2B) ³⁾	574508	

System	Pressing contour	Art.-No.	
Viega ProPress System USA	VUS ½" (OD 15,9 mm)	571770	
	VUS ¾" (OD 22,2 mm)	571775	
	VUS 1" (OD 28,6 mm)	571780	
	VUS 1¼" (OD 34,9 mm)	571785	
	VUS 1½" (OD 41,3 mm)	571790	
XL-C/XL-S	VUS 2" (OD 54,0 mm)	571795	
	VUSF 2½" (PR-3B) ^{3) 6)} (OD 66,7 mm)	572819	
XL-C/XL-S	VUSF 3" (PR-3B) ^{3) 6)} (OD 79,4 mm)	572820	
	VUSF 4" (PR-3B) ^{3) 6)} (OD 104,8 mm)	572821	
Viega Propress WATER System AUS	VAU 15 (OD 12,7 mm)	572687	
	VAU 20 (OD 19,1 mm)	572689	
	VAU 25 (OD 25,4 mm)	572691	
	VAU 32 (OD 31,8 mm)	572693	
	VAU 40 (OD 38,1 mm)	572695	
	VAU 50 (OD 50,8 mm)	572697	
Viega PropressG GAS System AUS	VAU 15 (OD 12,7 mm)	572687	
	VAU 20 (OD 19,1 mm)	572689	
	VAU 25 (OD 25,4 mm)	572691	
	VAU 32 (OD 31,8 mm)	572693	
	VAU 40 (OD 38,1 mm)	572695	
	VAU 50 (OD 50,8 mm)	572697	
Viega Raxofix	VRX 16	571750	
	VRX 20	571752	
	VRX 25	571754	
	VRX 32	571756	
	VRX 40	571758	
	VRX 50	571760	
Viega Sanfix ²⁾	VP 16/17*	570910	
	VP 20*	570915	
	VP 25*	570920	
	VP 32*	570925	
Viega Sanpress	V 12	570107	
	V 15	570115	
	V 18	570125	
	V 22	570135	
	V 28	570145	
	V 35	570155	
	V 42	570165	
	V 54	570175	
	VR 76,1 (PR-3B) ^{3) 6)}	572822	
	VR 88,9 (PR-3B) ^{3) 6)}	572823	
	VR 108,0 (PR-3B) ^{3) 6)}	572824	
	V 12 45° (PR-2B) ³⁾	574502	
	V 15 45° (PR-2B) ³⁾	574504	
	V 18 45° (PR-2B) ³⁾	574506	
	V 22 45° (PR-2B) ³⁾	574508	
	V 28 45° (PR-2B) ³⁾	574510	
	V 35 45° (PR-2B) ³⁾	574512	
Viega Sanpress Inox	V 15	570115	
	V 18	570125	
	V 22	570135	
	V 28	570145	
	V 35	570155	
	V 42	570165	
	V 54	570175	
	VF 64,0 (PR-3B) ^{3) 6)}	572815	
	VF 76,1 (PR-3B) ^{3) 6)}	572816	
	VF 88,9 (PR-3B) ^{3) 6)}	572817	
	VF 108,0 (PR-3B) ^{3) 6)}	572818	
	V 15 45° (PR-2B) ³⁾	574504	
	V 18 45° (PR-2B) ³⁾	574506	
	V 22 45° (PR-2B) ³⁾	574508	
	V 28 45° (PR-2B) ³⁾	574510	
	V 35 45° (PR-2B) ³⁾	574512	
	Viega Sanpress Inox G	V 15	570115
V 18		570125	
V 22		570135	
V 28		570145	
V 35		570155	
V 42		570165	
V 54		570175	
VF 64,0 (PR-3B) ^{3) 6)}		572815	
VF 76,1 (PR-3B) ^{3) 6)}		572816	
VF 88,9 (PR-3B) ^{3) 6)}		572817	
VF 108,0 (PR-3B) ^{3) 6)}		572818	
V 15 45° (PR-2B) ³⁾		574504	
V 18 45° (PR-2B) ³⁾		574506	
V 22 45° (PR-2B) ³⁾		574508	
V 28 45° (PR-2B) ³⁾		574510	
V 35 45° (PR-2B) ³⁾		574512	
Viessmann		TH 14*	570455
	TH 16*	570460	
	TH 20*	570470	
	TH 26*	570475	
	TH 32	570480	
	TH 40	570485	
	VSH MultiPress	U 14*	570760
		U 16*	570765
U 20*		570775	
U 25*		570780	
U 32		570785	
U 40		570790	
VSH SudoPress Carbon	V 12	570107	
	V 15	570115	
	V 18	570125	
	V 22	570135	
	V 28	570145	
	V 35	570155	
	V 42	570165	
	V 54	570175	
	VSH SudoPress Copper	V 12	570107
		V 15	570115
V 16		570117	
V 18		570125	
V 22		570135	
V 28		570145	
V 35		570155	
V 42		570165	
V 54		570175	
VSH SudoPress Stainless		V 12	570107
	V 15	570115	
	V 16	570117	
	V 18	570125	
	V 22	570135	
	V 28	570145	
	V 35	570155	
	V 42	570165	
	V 54	570175	

System	Pressing contour	Art.-No.
VSH SudoPress Copper Gas	V 12	570107
	V 14	570112
	V 15	570115
	V 16	570117
	V 18	570125
	V 22	570135
	V 28	570145
	V 35	570155
	V 42	570165
	V 54	570175
VSH SudoPress Copper Solar	V 14	570112
	V 15	570115
	V 16	570117
	V 18	570125
	V 22	570135
VSH SudoPress Stainless	V 15	570115
	V 18	570125
	V 22	570135
	V 28	570145
	V 35	570155
VSH SkinPress	V 42	570165
	V 54	570175
	TH 14*	570455
	TH 16*	570460
	TH 18*	570465
VSH SkinPress Gas	TH 20*	570470
	TH 26*	570475
	THL 32	570487
	TH 40	570485
	TH 50 (S)	572400
VSH SkinPress Carbon	TH 63 (S)	572405
	TH 16*	570460
	TH 20*	570470
	TH 26*	570475
	THL 32	570487
VSH XPress Copper	M 12	570100
	M 15	570110
	M 18 ¹⁾	570120
	M 22	570130
	M 28 ¹⁾	570140
	M 35	570150
	M 42 (4G)	570160
	M 54 (4G)	570170
	M 42 (PR-3S) ³⁾	572706
	M 54 (PR-3S) ³⁾	572708
	M 12 45° (PR-2B) ³⁾	574520
	M 15 45° (PR-2B) ³⁾	574522
	M 18 45° (PR-2B) ³⁾	574524
	M 22 45° (PR-2B) ³⁾	574526
	M 28 45° (PR-2B) ³⁾	574528
	M 35 45° (PR-2B) ³⁾	574530
	VSH XPress Copper GAS	M 15
M 18 ¹⁾		570120
M 22		570130
M 28 ¹⁾		570140
M 35		570150
M 42 (PR-3S) ³⁾		572706
M 54 (PR-3S) ³⁾		572708
M 15 45° (PR-2B) ³⁾		574522
M 18 45° (PR-2B) ³⁾		574524
M 22 45° (PR-2B) ³⁾		574526
VSH XPress Copper Solar	M 28 45° (PR-2B) ³⁾	574528
	M 35 45° (PR-2B) ³⁾	574530
	M 15	570110
	M 18 ¹⁾	570120
	M 22	570130
	M 28 ¹⁾	570140
	M 35	570150
	M 42 (PR-3S) ³⁾	572706
	M 54 (PR-3S) ³⁾	572708
	M 15 45° (PR-2B) ³⁾	574522
VSH XPress Stainless	M 18 45° (PR-2B) ³⁾	574524
	M 22 45° (PR-2B) ³⁾	574526
	M 28 45° (PR-2B) ³⁾	574528
	M 35 45° (PR-2B) ³⁾	574530
	M 15	570110
	M 18 ¹⁾	570120
	M 22	570130
	M 28 ¹⁾	570140
	M 35	570150
	M 42 (PR-3S) ³⁾	572706
VSH XPress Stainless Gas	M 54 (PR-3S) ³⁾	572708
	M 15 45° (PR-2B) ³⁾	574522
	M 18 45° (PR-2B) ³⁾	574524
	M 22 45° (PR-2B) ³⁾	574526
	M 28 45° (PR-2B) ³⁾	574528
	M 35 45° (PR-2B) ³⁾	574530
	M 15	570110
	M 18 ¹⁾	570120
	M 22	570130
	M 28 ¹⁾	570140

REMS pressing tongs REMS pressing rings

Accessories for REMS radial presses (except for REMS Mini-Press ACC, REMS Mini-Press 22 V ACC) and suitable radial presses of other makes

System	Pressing contour	Art.-No.
Walter Meier	U 16*	570765
Metalplast	U 18*	570770
	U 20*	570775
	U 25*	570780
	U 32	570785
	U 40	570790
	U 50	570795
	U 63 (PR-3B) ³⁾	572837
	U 63 (S)	572365
	U 75 (PR-3B) ³⁾	572828
Watts MTR	TH 16*	570460
Art press	TH 20*	570470
	TH 26*	570475
	TH 32	570480
WATTS	US 3/4"	571450
RADIANT	US 1/2"	571455
Watts WaterPEX	US 3/4"	571460
	US 1"	571465
	US 1 1/4"	571470
	US 1 1/2"	571475
WATTS	US 3/4"	571450
RADIANT	US 1/2"	571455
Watts	US 3/4"	571460
RadiantPEX	US 1"	571465
	US 1 1/4"	571470
	US 1 1/2"	571475
WATTS	U 16 (1/2")	570765
RADIANT	U 20 (5/8")	570775
Watts	U 25 (3/4")	570780
RadiantPEX-AL	U 32 (1")	570785
Wavin	U 14*	570760
Tigris K1	U 16*	570765
	U 20*	570775
	U 25*	570780
	U 32	570785
	U 40	570790
	U 50	570795
Wavin	U 14*	570760
Tigris M1	U 16*	570765
	U 20*	570775
	U 25*	570780
	U 32	570785
	U 40	570790
	U 50	570795
WeeConPress	M 12	570100
Alu	M 15	570110
	M 18	570120
	M 22	570130
	M 28	570140
	M 35	570150
	M 42 (4G)	570160
	M 54 (4G)	570170
	M 42 (PR-3S) ³⁾	572706
	M 54 (PR-3S) ³⁾	572708
	M 12 45° (PR-2B) ³⁾	574520
	M 15 45° (PR-2B) ³⁾	574522
	M 18 45° (PR-2B) ³⁾	574524
	M 22 45° (PR-2B) ³⁾	574526
	M 28 45° (PR-2B) ³⁾	574528
	M 35 45° (PR-2B) ³⁾	574530
	V 12	570107
	V 15	570115
	V 18	570125
	V 22	570135
	V 28	570145
	V 35	570155
	V 42	570165
	V 54	570175
	V 12 45° (PR-2B) ³⁾	574502
	V 15 45° (PR-2B) ³⁾	574504
	V 18 45° (PR-2B) ³⁾	574506
	V 22 45° (PR-2B) ³⁾	574508
	V 28 45° (PR-2B) ³⁾	574510
	V 35 45° (PR-2B) ³⁾	574512
	SA 12	570930
	SA 15	570935
	SA 18	570940
	SA 22	570945
	SA 28	570950
	SA 35	570955

System	Pressing contour	Art.-No.
WeeConPress	M 12	570100
C-Stahl	M 15	570110
	M 18	570120
	M 22	570130
	M 28	570140
	M 35	570150
	M 42 (4G)	570160
	M 54 (4G)	570170
	M 42 (PR-3S) ³⁾	572706
	M 54 (PR-3S) ³⁾	572708
	M 12 45° (PR-2B) ³⁾	574520
	M 15 45° (PR-2B) ³⁾	574522
	M 18 45° (PR-2B) ³⁾	574524
	M 22 45° (PR-2B) ³⁾	574526
	M 28 45° (PR-2B) ³⁾	574528
	M 35 45° (PR-2B) ³⁾	574530
WeeConPress	M 12	570100
Inox	M 15	570110
	M 18	570120
	M 22	570130
	M 28	570140
	M 35	570150
	M 42 (4G)	570160
	M 54 (4G)	570170
	M 42 (PR-3S) ³⁾	572706
	M 54 (PR-3S) ³⁾	572708
	M 12 45° (PR-2B) ³⁾	574520
	M 15 45° (PR-2B) ³⁾	574522
	M 18 45° (PR-2B) ³⁾	574524
	M 22 45° (PR-2B) ³⁾	574526
	M 28 45° (PR-2B) ³⁾	574528
	M 35 45° (PR-2B) ³⁾	574530
WeeConPress	M 12	570100
Kupfer	M 15	570110
	M 18	570120
	M 22	570130
	M 28	570140
	M 35	570150
	M 42 (4G)	570160
	M 54 (4G)	570170
	M 42 (PR-3S) ³⁾	572706
	M 54 (PR-3S) ³⁾	572708
	M 12 45° (PR-2B) ³⁾	574520
	M 15 45° (PR-2B) ³⁾	574522
	M 18 45° (PR-2B) ³⁾	574524
	M 22 45° (PR-2B) ³⁾	574526
	M 28 45° (PR-2B) ³⁾	574528
	M 35 45° (PR-2B) ³⁾	574530
WeeConFlex	H 16*	570320
MVR	H 20*	570350
	H 26*	570370
	H 32	570380
	U 40	570790
	U 50	570795
	U 63 (PR-3B) ³⁾	572837
	U 63 (S)	572365
	TH 16*	570460
	TH 20*	570470
	TH 26*	570475
	TH 32	570480
	TH 40	570485
	TH 50 (S)	572400
	TH 63 (S)	572405
WEM	U 16*	570765
WIELAND	TH 14 ²⁾	570455
cuprotherm	TH 16 ²⁾	570460
CTX ²⁾	TH 18 ²⁾	570465
	TH 20 ²⁾	570470
	TH 26 ²⁾	570475
WKS-Press	TH 14*	570455
	TH 16*	570460
	TH 17*	570462
	TH 20*	570470
	TH 26*	570475
	TH 32	570480
	TH 40	570485

System	Pressing contour	Art.-No.
XtraConnect	F 16*	570717
	F 20*	570727
	F 26*	570730
	F 32	570735
	H 16*	570320
	H 20*	570350
	H 26*	570370
	H 32	570380
	TH 16*	570460
	TH 20*	570470
	TH 26*	570475
	TH 32	570480
	U 16*	570765
	U 20*	570775
(DN 26)	U 25*	570780
	U 32	570785
	VP 16*	570910
	VP 20*	570915
	VP 32	570925
Zetaesse	TH 14*	570455
Multistrato	TH 16*	570460
EUROPEX	TH 18*	570465
	TH 20*	570470
	TH 26*	570475
	TH 32	570480
	U 14*	570760
	U 16*	570765
	U 18*	570770
	U 20*	570775
Zetaesse	TH 14*	570455
Multistrato	TH 16*	570460
ISOPEX	TH 18*	570465
	TH 20*	570470
	TH 26*	570475
	TH 32	570480
	U 14*	570760
	U 16*	570765
	U 18*	570770
	U 20*	570775
Zetaesse Rame	TH 14*	570455
HydroSAN	TH 16*	570460
	TH 20*	570470
	U 14*	570760
	U 16*	570765
	U 20*	570775
Zetaesse Rame	TH 14*	570455
ThermoSAN	TH 16*	570460
	TH 20*	570470
	U 14*	570760
	U 16*	570765
	U 20*	570775
ZEWOTHERM	TH 12*	570452
	TH 16*	570460
	TH 17*	570462
	TH 18*	570465
	TH 20*	570470
	TH 26*	570475
	TH 32	570480
	TH 40	570485
	TH 50 (S)	572400
	TH 63 (S)	572405
ZURN	US 3/4"	571450
INDUSTRIES	US 1/2"	571455
ZURN PEX	US 3/4"	571460
	US 1"	571465
	US 1 1/4"	571470
	US 1 1/2"	571475
	US 2"	571477

Pressfitting systems for gas installations must only be pressed with pressing tongs/pressing rings which are highlighted in yellow.

Observe the national regulations.

* These pressing tongs also fit the manual radial press REMS Eco-Press. Observe the national regulations.

¹⁾ Only pressing tongs from designation "108" (1st quarter of 2008), "208" (2nd quarter of 2008) etc. can be used. The designation is stamped on every pressing jaw.

²⁾ For this pressfitting system producing a pressing joint with manual radial presses is not permitted.

³⁾ Adapter tongs are required for driving pressing rings (PR), see page 160.

⁴⁾ Press fittings made of red bronze (ProPress XL) must be pressed with pressing rings with press contour VUSR, copper fittings (ProPress XL-C) and stainless steel fittings (ProPress XL-S) with pressing rings with press contour VUSF.

⁵⁾ For taking suitable pressing inserts.

⁶⁾ Press fittings made of red bronze (Sanpress XL) must be pressed with pressing rings with press contour VR, copper fittings (Profipress XL, Profipress G XL), carbon steel (Prestabo XL) and stainless steel fittings (Sanpress Inox XL, Sanpress Inox G XL) with pressing rings with press contour VF.

⁷⁾ Driven by REMS Power-Press XL.

The suitability of REMS pressing tools for pressfitting systems: Date 09.10.2015. For the updated situation regarding suitability status check our website:

www.rems.de → Downloads → Product catalogues, brochures → REMS Catalogue.

Pressing tongs/pressing rings for additional pressfitting systems on request.

REMS pressing tongs REMS pressing rings

Accessories for REMS radial presses (except for REMS Mini-Press ACC, REMS Mini-Press 22 V ACC) and suitable radial presses of other makes

REMS pressing tongs

REMS pressing tongs with two pivoted mono block pressing jaws. Top-selling standard version.

REMS pressing tongs (4G)

REMS pressing tongs (4G) with two pivoted, parallel aligned pressing segments for linear pressing of midsize dimensions.



REMS pressing tongs (S)

REMS pressing tongs (S) with one fixed and two pivoted pressing segments, for midsize dimensions.

REMS pressing rings (PR-3S)

REMS pressing ring (PR-3S) with 3 swivellable pressing segments mounted on a jointed ring for large dimension complex pressings. Ideal pressing through radially controlled movement of pressing segments, with adaptor tongs.



REMS pressing rings (PR-3B)

REMS pressing rings (PR-3B) with 3 pressing segments for high quality, large dimension pressings Optimum pressing by radially controlled movement of the pressing segments with adaptor tongs.

REMS pressing rings 45° (PR-2B)

REMS pressing ring 45° (PR-2B) with 2 pressing jaws for pressings at places of difficult access, with adaptor tongs.



Accessories

Description	Art.-No.
Adapter tongs Z1 for driving REMS pressing rings 45° (PR-2B)	574500
Adapter tongs Z2 for driving REMS pressing rings M 42–54 (PR-3S)	572795
Adapter tongs Z4 for driving REMS pressing rings F 75 (PR-3B), TH 63–75 (PR-3B), U 63–75 (PR-3B)	572801
Adapter tongs Z5 for driving REMS pressing rings VF/VR 64–108 (PR-3B), VUSF/VUSR 2½–4" (PR-3B), VAUF 65–100 (PR-3B), ECI 2½–3" (PR-3S)	572802
Adapter tongs Z6 (XL) for driving REMS pressing rings ECI 4" (XL PR-3S) with REMS Power-Press XL	579120
Steel case with insert for 6 pressing tongs (up to Ø 35 mm/1" and pressing tongs U 40, U 50, TH 40, F 40, F 50, G 40, VUS 1¼")/cropping tongs and compartment for pipe cutter up to 42 mm	570295
Steel case with insert for 2 pressing tongs (M 42 (4G), M 54 (4G), V 42, V 54, H 40, H 40 A, VUS 1½", VUS 2")	570290
Steel case with insert for adapter tongs with pressing rings M 42 (PR-3S) and M 54 (PR-3S) or with pressing rings SA 42 (PR-3S) and M 54 (PR-3S).	572810
Steel case with inlay for adapter tongs and 4 pressing rings VF 64,0–108,0/VR 76,1–108,0/VUSF 2½–4"/VUSR 2½–4" (PR-3B)	572809
Steel case with insert for adapter tongs Mini Z1 and adapter tongs Z1 and 6 REMS pressing rings V 12–35 45° (PR-2B) or M 12–35 45° (PR-2B)	574516



Confirmation of suitability

The suitability of crimping tools is determined basically by the manufacturer of crimping tools. Moreover the suitability of REMS crimping tools has been confirmed by the system manufacturer/supplier himself or approved through independent testing institutes.

Confirmation of suitability through the system manufacturer/supplier

More than 90 % of the manufacturers/suppliers of the pressfitting systems listed herein have tested REMS pressing tongs and confirmed the suitability for their pressfitting system.

Confirmation of suitability through independent testing institutes

The suitability of REMS pressing tongs for additional pressfitting systems have been confirmed through independent technical institutes:

TÜV-Certificates

Exist for Geberit Mepla, Geberit Mapress C-STAHL, Geberit Mapress EDELSTAHL, Geberit Mapress Kupfer, Nussbaum Cupress, Nussbaum Optipress, Uponor Unipipe, Viega-'profipress', Viega-'profipress G', Viega-'sanfix P', Viega-'sanpress', Viega-'Viegatherm P', Wavin Tigris. The TÜV-certificates confirm that REMS crimping tools are suitable for producing perfect and system-conformity pressing joints corresponding to these systems.

Suitability test according to DVGW W 534 (potable water)

Pressing joints produced with REMS pressing tools were tested by the state-operated material testing institute in Darmstadt/Germany or the material testing institute of the Land of North-Rhine-Westphalia, Germany according to DVGW work sheet W 534. These material testing institutes are certified by the DVGW for making these tests. A representative cross-section of press joints of pressfitting systems Geberit Mapress Edelstahl, Raccorderie Metalliche inoxPRES, Raccorderie Metalliche steelPRES, Uponor Unipipe, Viega Profipress and Viega Raxofix, was tested. The tests led to the result that all REMS pressing tools are suitable for producing perfect and system conformity pressing joints in accordance with these systems.

Suitability test according to DVGW G 5614/VP 625 or prEN 1254-7 (gas)

Pressing joints made with REMS pressing tools have been tested by the TÜV or by the Land Material Testing Institute Nordrhein-Westfalen or the DVGW Research Institute Karlsruhe according to DVGW Regulations G 5614/VP 625 or by the BSI (UK) according to prEN 1254-7. A representative cross-section of pressing joints of the pressfitting systems Geberit Mapress Edelstahl Gas, Geberit Mapress Kupfer Gas, Henco Gas, IBP >B<press Gas, Kembla KemPress Gas, Pegler Yorkshire X-Press Copper Gas, Raccorderie Metalliche inoxPRES Gas, Uponor MLC-G, Valsir PEXAL Gas, Viega Profipress G, Viega Pexfit G, Viega Sanpress INOX G, Viega PropressG GAS System (AUS) was tested. The tests led to the result that all REMS pressing tools are suitable for producing perfect and system conformity pressing joints in accordance with these systems.



potable water



gas

Hold-Harmless and Indemnification Agreement

REMS is the first system-independent machine and tool manufacturer to sign liability acceptance agreements for pressing tools.

A hold-harmless and indemnification agreement exists with the:

Zentralverband Sanitär Heizung Klima (Central Organization for the Sanitary-, Heating- and Climatization Industries),
Rathausallee 6, D-53757 St. Augustin,
referred to in the following as "ZVSHK",

Bundesindustrieverband Technische Gebäudeausrüstung e.V.,
Hinter Hoben 149, 53129 Bonn,
referred to in the following as "BTGA",

Verband Deutscher Kälte-Klima-Fachbetriebe e. V. (German Association for Coolant & Air-Conditioning Profession Industries),
Kaiser-Friedrich-Straße 7, D-53113 Bonn,
referred to in the following as "VDKF",

Schweizerisch-Liechtensteinischem Gebäudetechnikverband (Swiss-Liechtenstein Technical Building Association),
Auf der Mauer 11, CH-8023 Zürich,
referred to in the following as "suissetec",

The Zentralverband Sanitär Heizung Klima (ZVSHK), the Bundesindustrieverband Technische Gebäudeausrüstung e. V. (BTGA), the Verband Deutscher Kälte-Klima-Fachbetriebe e. V. (VDKF) and the Schweizerisch-Liechtensteinische Gebäudetechnikverband (suissetec) have made liability acceptance agreements in the interests of trade and industry with REMS GmbH & Co KG (REMS) for the radial pressing tools.

- Manual radial press REMS Eco-Press
- Cordless radial press REMS Mini-Press ACC
- Cordless radial press REMS Mini-Press 22V ACC
- Electric radial press REMS Power-Press SE
- Electro-hydraulic radial press REMS Power-Press
- Electro-hydraulic radial press REMS Power-Press ACC
- Cordless radial press REMS Akku-Press
- Cordless radial press REMS Akku-Press ACC
- REMS pressing tongs
- REMS pressing rings
- REMS pressing tongs Mini

This makes REMS the first system-independent machine- and tool manufacturer to have concluded a hold-harmless and indemnification agreement for pressing tools. The conclusion of the agreement was effected on the basis of a successful cooperation established on partnership between REMS, the crafts, trades and industry and their organizations.

Eligible for services and performances from this agreement are all independent professional craftsmen, and companies of such, who are enrolled in the register of artisans and craftsmen (referred to in the following as "SHK-Establishments"), in as far as they have been members of the crafts guild of the sanitary- heating- and climatization enterprises competent for their business location at the time the damage event has arisen, and this crafts guild is associated with a regional guild association, which is a member of the ZVSHK.

Entitled to the services from the agreement with the BTGA are all building technology companies (hereinafter referred to as "TGA companies") insofar as they were a member of the Bundesindustrieverband Technische Gebäudeausrüstung responsible at the seat of their company at the time of the damage case and therefore an indirect member of the BTGA or direct member of the BTGA.

Eligible for services and performances from this agreement with the VDKF are all coolant systems companies or professional organisations (referred to as Coolant and Air-Conditioning Profession Industries) who, at the time the damage is caused, are members of the VDKF.

Eligible for services and performances from this agreement are all building systems companies (following TGA companies) who, at the time the damaged is caused, are members of suissetec.

In as far as the radial pressing tools mentioned show a defect with regard to construction, manufacture or material, or if the operator's manuals are faulty, thereby causing damage for the customer of the SHK-establishment, the Coolant and Air-Conditioning Profession Industries, or the TGA-companies, for which the SHK-establishment or the TGA-company is liable, then REMS shall be additionally liable - aside of the statutory prescriptions – for the consequences resulting from leakage, in accordance with the stipulations and provisions of this hold-harmless agreement.

The hold-harmless and indemnification agreement shall be independently valid, regardless of which pressfitting system is pressed with the REMS pressing tools. The current status regarding suitability of the REMS pressing tools for pressfitting systems can be viewed on the Internet: www.rems.de → Downloads → Product catalogues, brochures → REMS Catalogue.

Please consult Mr. Walter Hindelang for further information:
walter.hindelang@rems.de.



German Quality Product

Reliable and safe: REMS was the first system-independent machine and tool manufacturer to sign liability acceptance agreements for pressing tools as early as the year 2000.



REMS cropping tongs

Accessories for REMS radial presses (except for REMS Mini-Press ACC, REMS Mini-Press 22V ACC) and suitable radial presses of other makes

High performance cropping tongs in forged and specially hardened steel for cutting threaded rods.

Steel, stainless steel up to hardness classification 4.8 (400 N/mm²) M 6–M 12

REMS cropping tongs – for cutting threaded rods.

Made of forged and specially hardened steel.

Reversible cropping inserts for double service life.

M cropping inserts with high precision thread contour machined on CNC machining centres for exact guiding of the threaded rod in the cutting process. Pliers parts, cropping inserts and specially machined and hardened cutting edges, made to fit exactly, for cutting without burr.

Threaded rod can be screwed into a threaded connection of the pipe clip or the nut without rework after cutting.

Cutting device in pliers design (**Patent EP 1 459 825, patent US 7,284,330**). Drive through all REMS radial presses (except for REMS Mini-Press ACC, REMS Mini-Press 22V ACC) and through suitable radial presses of other makes. All cropping tongs marked with * have an optional connection (**Patent EP 1 223 008, patent US 6,739,172**) for manual drive through the radial press REMS Eco-Press.



Supply format

REMS cropping tongs. Cropping tongs with 1 pair of reversible cropping inserts for steel, stainless steel, M 6–M 12. In a carton.

Description	for threaded rods	Art.-No.
REMS cropping tongs M 6*	M 6	571890
REMS cropping tongs M 8*	M 8	571895
REMS cropping tongs M 10	M 10	571865
REMS cropping tongs M 12	M 12	571870



German Quality Product



Patent EP 1 223 008
Patent US 6,739,172
Patent EP 1 459 825
Patent US 7,284,330

Accessories

Description	for threaded rods	Art.-No.
Cropping inserts M 6 (pair)	M 6	571891
Cropping inserts M 8 (pair)	M 8	571896
Cropping inserts M 10 (pair)	M 10	571866
Cropping inserts M 12 (pair)	M 12	571871
Steel case with insert for 6 cropping tongs/pressing tongs and compartment for pipe cutter up to 42 mm		570295



REMS cable shear

Accessories for REMS radial presses (except for REMS Mini-Press ACC, REMS Mini-Press 22V ACC) and suitable radial presses of other makes

High-grade cable shear in forged and specially hardened steel for cutting electric cable.

Electric cable ≤ 300 mm² (Ø 30 mm)

REMS cable shear – Easy cutting of electric cable.

Made of forged and specially hardened steel.

Replaceable cutting blades manufactured on CNC production centres ensure a precision blade geometry and long service life. Large cutting range.

Drive through electric REMS radial presses (except for REMS Mini-Press ACC, REMS Mini-Press 22V ACC) and through suitable radial presses of other makes.



German Quality Product



Supply format

REMS cable shear. Cable shears with 2 changeable cable cutters for electric cables ≤ 300 mm² (Ø 30 mm). In a carton.

Description	Art.-No.
REMS cable shear	571887



Accessories

Description	Art.-No.
Cable cutters (pack of 2)	571889

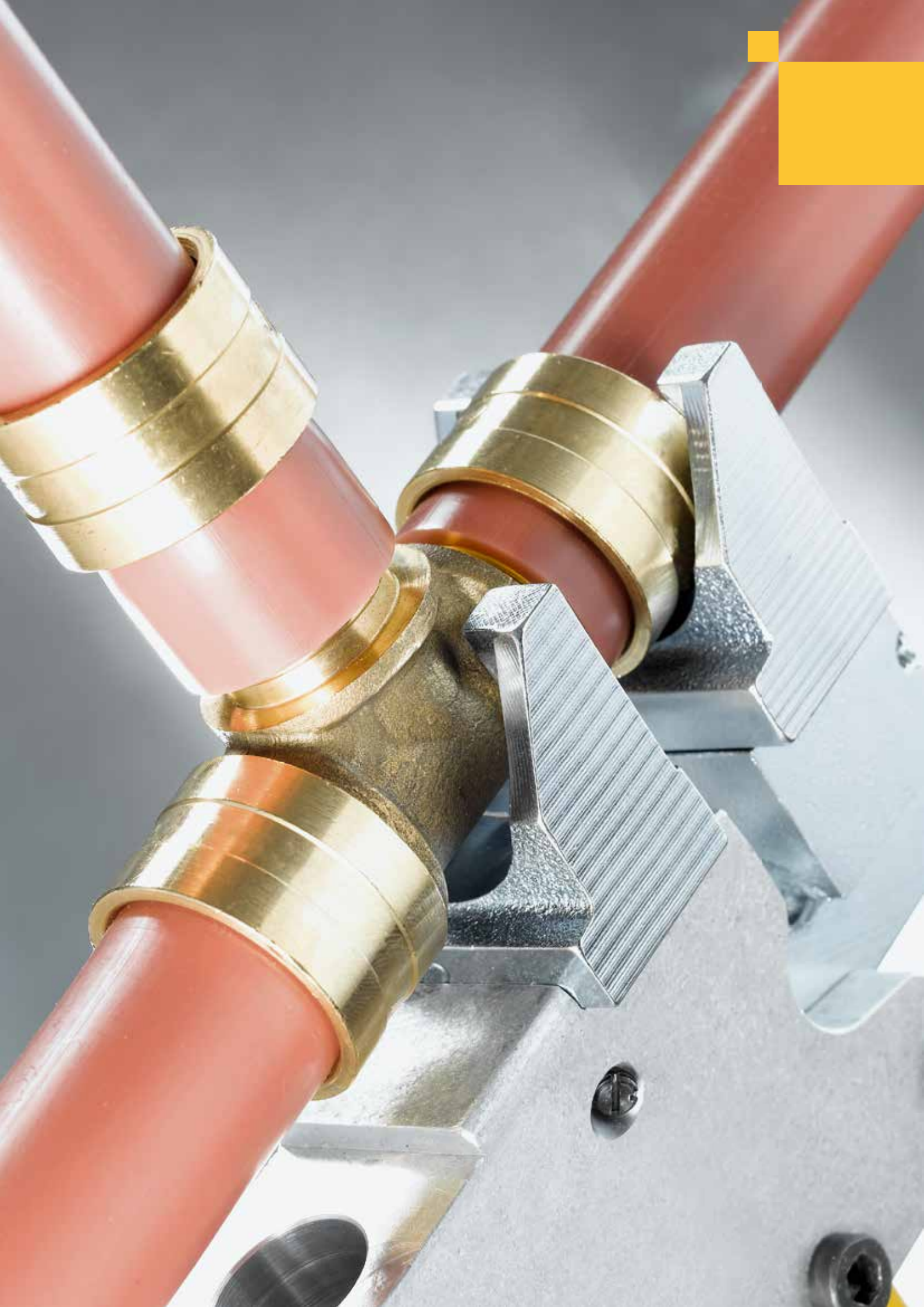



Axial Press Jointing

	Cordless axial press 25 / 25 L	166
	Manual axial press	168
	Compression heads	169
	Cordless axial press 30 / 40 Compression heads	172

REMS Ax-Press 25 / 25 L ACC

Cordless axial press with automatic return

Compact, handy electric tool for producing compression sleeve joints and for expanding tubes. For battery and corded operation. For trade and industry. For the building site and the workshop.

Axial compression Ø 12–40 mm

REMS Ax-Press 25 ACC – universal up to Ø 40 mm. Super light, super handy. Fast. With automatic return. Optimum weight distribution for single-hand operation. Swivelling compression device.

System advantage

Only **one** type of compression heads for REMS Ax-Press HK, REMS Ax-Press H, REMS Ax-Press 25 and REMS Ax-Press 25 L. Thus easy, economic stocking.

Compression heads for all common systems

Full range of REMS compression heads for all common compression sleeve systems (page 169–170). Choice of REMS compression heads with spring lock for

seating common compression inserts. High-grade compression heads in forged and specially hardened steel. The REMS compression heads are system-specific and meet the demands of compression sleeve systems. Thus perfect system-conformity, safe jointing.

Expander heads for all common systems

Complete assortment of REMS expander heads for all common compression sleeve systems. The REMS compression heads are system-specific and correspond to the respective compression sleeve system. Thus perfect system-conformity, precise expanding.

Design

Compact, handy, light. REMS Ax-Press 25 drive machine with battery weighs only 2.9 kg, only 29 cm long REMS Ax-Press 25 L drive machine with battery weighs only 3.1 kg, only 32 cm long REMS Ax-Press 25 and REMS Ax-Press 25 L with 40 mm stroke respectively REMS Ax-Press 25 with preset compression head position for pressing compression sleeve connectors with a clamping distance ≤ 82 mm in one action REMS Ax-Press 25 L with selectable compression head position for pressing compression sleeve connectors with a clamping distance ≤ 116 mm in one action and for double pressings. Works anywhere, free-hand, overhead, in confined areas. Optimum weight distribution for single-hand operation. Ergonomically shaped housing with recessed grip. Integrated LED work light for illuminating the work place. Swivelling compression device for working in confined area. Extension for enlarging the clamping distance on the pressing sleeve connector, also for double pressings, as an accessory. Compression heads quickly interchangeable, without tools. Secure spring lock seating of compression heads. For battery and corded operation. Electronic charging status check with flat battery protection and charging status indicator with 2-coloured LED.

Drive

Enormous pressing force for fast and perfect jointing. Powerful electro-hydraulic drive with automatic return (ACC), eccentric reciprocating pump with robust planetary gear. Powerful electro-hydraulic drive with powerful battery motor 14.4 V, 420 W output, robust planetary gear, eccentric reciprocating pump and compact high power hydraulic system. Safety tip switch.

Battery or mains operation

Li-Ion PLUS technology. Highly resistant Li-Ion 14.4 V battery with 1.5 or 3.0 Ah capacity for long service life. Powerful and light. Total discharge and overload protection with single cell monitoring. Temperature monitoring during the charging process. Operating temperature range –10 to +60 °C. No memory effect for maximum battery power. Rapid charger for short charging times. Li-Ion 230 V voltage supply for mains operation instead of Li-Ion 14.4 V battery, as accessory.

Expanding

Various pipe expanders and complete range of REMS expanding heads for all common pressure sleeve systems



←ACC→
Automatic Circuit Control

with automatic circuit control and charging status check

e.g.
aquatherm,
Genreal Fittings,
IVT,
REHAU,
REVEL,
ROTEX,
Seppelfricke,
TECE,
TIEMME,
Würth

REMS TECHNOLOGY
LI-ION PLUS



←ACC→
Automatic Circuit Control

with automatic circuit control and charging status check

e.g.
AC-FIX,
BARBI,
BRASELI,
Brass & Fittings,
EUROP FLUIDES,
Fittings Estándar,
ISOLTUBEX,
PLÁSTICOS FERRO,
SURE HISPANIA,
Velta

REMS TECHNOLOGY
LI-ION PLUS

Tested by electro:suisse >>>

German Quality Product

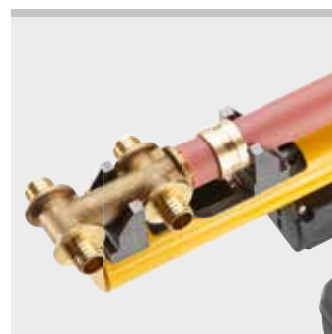

Supply format

REMS Ax-Press 25 ACC Basic-Pack. Cordless axial press for producing compression sleeve joints Ø 12–40 mm. 40 mm stroke, for pressing compression sleeve connections with a clamping distance ≤ 82 mm. For driving REMS pressing heads. Electro-hydraulic drive with powerful battery motor 14,4 V, 420 W, robust planetary gear, eccentric reciprocating pump and compact high power hydraulic system, safety tip switch, swivelling pressing device. Integrated LED work light. Battery Li-Ion 14.4 V, 1.5 Ah, rapid charger Li-Ion/Ni-Cd 230 V or 110 V, 50–60 Hz, 50 W. Without compression heads. In sturdy steel case.

Art.-No.	
573033	

Other voltages on request.



Supply format

REMS Ax-Press 25 L ACC Basic-Pack. Cordless axial press for producing compression sleeve joints Ø 12–40 mm. 40 mm stroke, for pressing compression sleeve connections with a clamping distance ≤ 116 mm. For driving REMS pressing heads. Electro-hydraulic drive with powerful battery motor 14,4 V, 420 W, robust planetary gear, eccentric reciprocating pump and compact high power hydraulic system, safety tip switch, swivelling pressing device. Integrated LED work light. Battery Li-Ion 14.4 V, 1.5 Ah, rapid charger Li-Ion/Ni-Cd 230 V or 110 V, 50–60 Hz, 50 W. Without compression heads. In sturdy steel case.

Art.-No.	
573034	

Other voltages on request.



Combi Set

Space and weight saving Combi Set, consisting of REMS Ax-Press 25 ACC and REMS Akku-Ex-Press P ACC For fast and simple expanding of pipes and pressing of compression sleeve connectors with a clamping distance of ≤ 82 mm For details of the REMS Akku-Ex-Press P ACC. see page 179. Advantage: only 1 steel case for REMS Ax-Press 25 ACC and REMS Akku-Ex-Press P ACC, expanding heads and compression heads Price advantage.

Supply format

REMS Ax-Press 25 ACC / Akku-Ex-Press P ACC Combi Set Basic. Space and weight saving Combi Set, consisting of REMS Ax-Press 25 ACC drive machines for producing compression sleeve connections Ø 12–40 mm, with 40 mm stroke, for pressing compression sleeve connectors with a clamping distance of ≤ 82 mm and REMS Akku-Ex-Press P ACC for fast expanding of plastic and composite tubes Ø 12–40 mm. 2 Li-ion 14.4 V, 1.5 Ah batteries, Li-ion/Ni-Cd 230 V, 50–60 Hz, 65 W rapid charger. Without compression heads. Without expanding heads. In sturdy steel case.

Art.-No.	
573035	

Other voltages on request.



Accessories

Description	Art.-No.
REMS compression heads see page 169–170.	
Expander heads P see page 181.	
REMS Ax-Press 25 ACC drive unit , without battery	573003
REMS Ax-Press 25 L ACC drive unit , without battery	573004
REMS Akku-Ex-Press P ACC drive unit , without battery	575008
Battery Li-Ion 14,4 V, 1.5 Ah	571545
Battery Li-Ion 14.4 V, 3.0 Ah	571555
Rapid charger Li-Ion/Ni-Cd 230 V , 50–60 Hz, 65 W	571560
Voltage supply Li-Ion 230 V for mains operation instead of battery Li-Ion 14.4 V.	571565
Steel case with insert	578290
Steel case with inlay for cordless axial press and cordless pipe expander	573284
REMS cordless LED lamp see page 95	175200



REMS Ax-Press HK / H

One-hand axial press / Manual axial press

Universal manual axial press for producing compression sleeve joints.

Axial compression Ø 12–32 mm

REMS Ax-Press HK – universal up to Ø 22 mm
Ultra small, ultra light, ultra handy. Only 1.1 kg

REMS Ax-Press H – universal up to Ø 32 mm.
Handy and light. Only 1.4 kg.

Complete assortment of REMS compression heads, quickly interchangeable.

System advantage

Only **one** type of compression heads for REMS Ax-Press HK, REMS Ax-Press H, REMS Ax-Press 25 and REMS Ax-Press 25 L. Thus easy, economic stocking.

Compression heads

Full range of REMS compression heads for all common compression sleeve systems (page 169–170). Choice of REMS compression heads with spring lock for seating common compression inserts. High-grade compression heads in forged and specially hardened steel. The REMS compression heads are system-specific and meet the demands of compression sleeve systems. Thus perfect system-conformity, safe jointing.

Design

Compact, job site proven. Handy and light. REMS Ax-Press HK drive unit only 1.1 kg. REMS Ax-Press H drive unit only 1.4 kg. Works anywhere, free-hand, also in tight spots. 66 mm stroke. Quick-acting forward and release for easy, fast operation. Selectable compression head position (**Patent ES 2 273 563, Patent FR 05 03513, Patent DE pending**) for pressing compression sleeve connectors with a clamping distance of ≤ 161 mm in one action and for double pressings. Quick-change compression heads and pressing inserts without tools. Secure fit of compression heads and pressing inserts by spring catch. REMS Ax-Press H with overload protection.

Expanding

Various pipe expanders and complete range of REMS expanding heads for all common compression sleeve systems (page 178–181).



Patent ES 2 273 563
Patent FR 05 03513
Patent DE pending

e.g.
AC-FIX,
BARBI,
BRASELI,
Brass & Fittings,
COMAP,
EUROPFLUIDES,
Fittings Estándar,
ISOLTUBEX,
PB TUB,
PLÁSTICOS FERRO,
RIQUIER,
ROTEX,
SURE HISPANIA,
TECE,
TIEMME,
VELTA



German Quality Product



Supply format

REMS Ax-Press HK drive unit. Axial press for single-handed operation for producing compression sleeve joints Ø 12–22 mm. 66 mm stroke. With quick-acting forward and release. For driving REMS compression heads. In a carton.

	Art.-No.	
	574302	

Supply format

REMS Ax-Press H drive unit. Manual axial press for producing compression sleeve joints Ø 12–32 mm. 66 mm stroke. With quick-acting forward and release. For driving REMS compression heads. In a carton.

	Art.-No.	
	574300	

Accessories

Description	Art.-No.	
REMS compression heads see page 169–170.		
Carrying bag for REMS Ax-Press HK/H drive unit and compression heads	574437	
Case with inlay for REMS Ax-Press HK drive unit and compression heads	574352	



REMS compression heads

Accessories for REMS Ax-Press HK, REMS Ax-Press H, REMS Ax-Press 25, REMS Ax-Press 25 L



REMS compression heads with spring lock for commercially available press inserts

Description	Use
Compression head Basic 20 (pack of 2)	for pipe fittings 20 mm and for standard press inserts outer Ø 20 mm
Compression head Basic 25 (pack of 2)	for pipe fittings 25 mm and for standard press inserts outer Ø 25 mm
Compression head Basic 32 (pack of 2)	for pipe fittings 32 mm and for standard press inserts outer Ø 32 mm

Commercially available press inserts:

T's and elbows

Dm 16

Dm 20

Dm 22

Dm 25

Dm 32

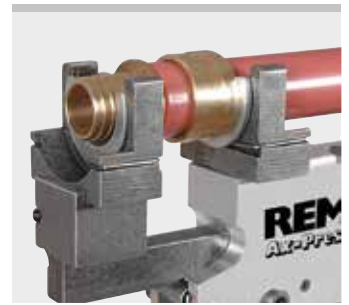

REMS compression head for T-pieces, elbows, splitters, transition pieces

Description	Use
Compression head UNI T/L (piece)	for T-pieces, elbows, splitters, in combination with an additional compression head; for transition pieces, in combination with a support bolt

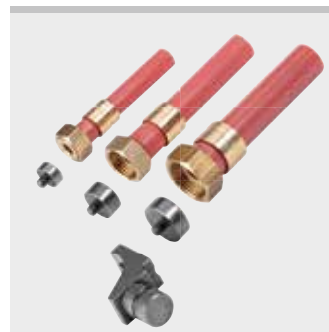

REMS support bolt for transition pieces

Description	for transition pieces inch	Art.-No.
Support bolt 3/8"	3/8	573647
Support bolt 1/2"	1/2	573648
Support bolt 3/4"	3/4	573649



REMS compression heads

Accessories for REMS Ax-Press HK, REMS Ax-Press H, REMS Ax-Press 25, REMS Ax-Press 25 L

Select compression heads yourself!

Search for the required compression sleeve system in the table below and select the correct compression heads.

High-grade compression heads in forged and specially hardened steel. Quickly interchangeable, without tools. The REMS compression heads are system-specific and comply with the requirements of the respective compression sleeve system. Thus perfect system-conformity, safe jointing. Drive through REMS axial presses.

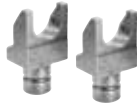

Compr. heads Uni



Compr. head UNI T/L

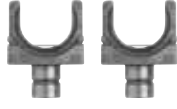

Compr. heads Basic for press inserts

Pressure sleeves system	Compression head mm	Number of pressing heads	fits REMS Ax-Press				Art.-No.	
			HK ¹⁾	H	25	25L		
AC-FIX (Global Piping System)	UNI 12	2	•	•	•	•	573630	
	UNI 16	2	•	•	•	•	573632	
	UNI 20	2	•	•	•	•	573636	
	UNI 25	2	•	•	•	•	573640	
	UNI 32	2	•	•	•	•	573644	
	UNI T/L**	1	•	•	•	•	573646	
	Basic 20*	2	•	•	•	•	573624	
	Basic 25*	2	•	•	•	•	573616	
	Basic 32*	2	•	•	•	•	573628	
	aquatherm	AT 16	2			•		573120
AT 20		2			•		573122	
AT 25		2			•		573124	
AT 32		2			•		573126	
AT 40		2			•		573128	
BARBI GLADIATOR (Industrial Blansol)	UNI 16	2	•	•	•	•	573632	
	UNI 20	2	•	•	•	•	573636	
	UNI 25	2	•	•	•	•	573640	
	UNI 32	2	•	•	•	•	573644	
	UNI 40	2	•	•	•	•	573652	
	UNI T/L**	1	•	•	•	•	573646	
	Basic 20*	2	•	•	•	•	573624	
	Basic 25*	2	•	•	•	•	573616	
	Basic 32*	2	•	•	•	•	573628	
	BARBI RETICULADO (Industrial Blansol)	UNI 12	2	•	•	•	•	573630
UNI 16		2	•	•	•	•	573632	
UNI 20		2	•	•	•	•	573636	
UNI 25		2	•	•	•	•	573640	
UNI 32		2	•	•	•	•	573644	
UNI 40		2	•	•	•	•	573652	
UNI T/L**		1	•	•	•	•	573646	
Basic 20*		2	•	•	•	•	573624	
Basic 25*		2	•	•	•	•	573616	
Basic 32*		2	•	•	•	•	573628	
BRASELI	UNI 12	2	•	•	•	•	573630	
	UNI 16	2	•	•	•	•	573632	
	UNI 20	2	•	•	•	•	573636	
	UNI 25	2	•	•	•	•	573640	
	UNI 32	2	•	•	•	•	573644	
	UNI T/L**	1	•	•	•	•	573646	
	Basic 20*	2	•	•	•	•	573624	
	Basic 25*	2	•	•	•	•	573616	
	Basic 32*	2	•	•	•	•	573628	
	Brass & Fittings	UNI 16	2	•	•	•	•	573632
UNI 20		2	•	•	•	•	573636	
UNI 25		2	•	•	•	•	573640	
UNI 32		2	•	•	•	•	573644	
UNI T/L**		1	•	•	•	•	573646	
Basic 20*		2	•	•	•	•	573624	
Basic 25*		2	•	•	•	•	573616	
Basic 32*		2	•	•	•	•	573628	
COMAP PEXY		UNI 12	2	•	•	•	•	573630
		UNI 16	2	•	•	•	•	573632
	UNI 20	2	•	•	•	•	573636	
	UNI 25	2	•	•	•	•	573640	
	UNI 32	2	•	•	•	•	573644	
	UNI T/L**	1	•	•	•	•	573646	
	Basic 25*	2	•	•	•	•	573616	
	Basic 32*	2	•	•	•	•	573628	
	EUROP FLUIDES HYDROFLUIDES	UNI 12	2	•	•	•	•	573630
		UNI 16	2	•	•	•	•	573632
UNI 20		2	•	•	•	•	573636	
UNI 25		2	•	•	•	•	573640	
UNI 32		2	•	•	•	•	573644	
UNI T/L**		1	•	•	•	•	573646	
Basic 25*		2	•	•	•	•	573616	
Basic 32*		2	•	•	•	•	573628	
Fittings Estándar		UNI 12	2	•	•	•	•	573630
		UNI 16	2	•	•	•	•	573632
	UNI 20	2	•	•	•	•	573636	
	UNI 25	2	•	•	•	•	573640	
	UNI 32	2	•	•	•	•	573644	
	UNI T/L**	1	•	•	•	•	573646	
	Basic 20*	2	•	•	•	•	573624	
	Basic 25*	2	•	•	•	•	573616	
	Basic 32*	2	•	•	•	•	573628	
	General Fittings Serie 3400 PEX	RE 16	2			•		573160
RE 20		2			•		573162	
RE 25		2			•		573172	
RE 32		2			•		573178	
RO 16		2			•		573184	
RO 20		2			•		573186	
General Fittings Serie 3400 PEX/AL/PEX		RE 16	2			•		573160
	RE 20	2			•		573162	
	RE 25	2			•		573172	
	RE 32	2			•		573178	
	RO 16	2			•		573184	
	RO 20	2			•		573186	
	General Fittings Serie 3700 PEX	TC 12/14/16	2			•		573360
TC 18/20		2			•		573364	
TC 25		2			•		573367	
TC 32		2			•		573370	
General Fittings Serie 3700 PEX/AL/PEX		TC 12/14/16	2			•		573360
	TC 18/20	2			•		573364	
	TC 25	2			•		573367	
	TC 32	2			•		573370	
	IVT PRINETO	IV 16	3			•		573320
IV 20		3			•		573325	
IV 25		3			•		573330	
IV 32		3			•		573335	

Pressure sleeves system	Compression head mm	Number of pressing heads	fits REMS Ax-Press				Art.-No.	
			HK ¹⁾	H	25	25L		
ISOLTUBEX	UNI 12	2	•	•	•	•	573630	
	UNI 16	2	•	•	•	•	573632	
	UNI 20	2	•	•	•	•	573636	
	UNI 25	2	•	•	•	•	573640	
	UNI 32	2	•	•	•	•	573644	
	UNI T/L**	1	•	•	•	•	573646	
	Basic 20*	2	•	•	•	•	573624	
	Basic 25*	2	•	•	•	•	573616	
	Basic 32*	2	•	•	•	•	573628	
	PB TUB Sertiglass	UNI 12	2	•	•	•	•	573630
UNI 16		2	•	•	•	•	573632	
UNI 20		2	•	•	•	•	573636	
UNI 25		2	•	•	•	•	573640	
UNI 32		2	•	•	•	•	573644	
UNI T/L**		1	•	•	•	•	573646	
Basic 25*		2	•	•	•	•	573616	
Basic 32*		2	•	•	•	•	573628	
PLÁSTICOS FERRO FERROPLAST		UNI 16	2	•	•	•	•	573632
		UNI 20	2	•	•	•	•	573636
	UNI 25	2	•	•	•	•	573640	
	UNI 32	2	•	•	•	•	573644	
	UNI T/L**	1	•	•	•	•	573646	
	Basic 20*	2	•	•	•	•	573624	
	Basic 25*	2	•	•	•	•	573616	
Basic 32*	2	•	•	•	•	573628		
PLUMBING PLUS EziPex Slide (AUS)	RH 16 L	2			•		573150	
	RH 20 L	2			•		573152	
	RH 16/20 L	2			•		573158	
	RH 25	2			•		573154	
	RH 32	2			•		573156	
REHAU RAUTHERM (serie S 5)	RH 12	2			•		573164	
	RH 16	2			•		573166	
	RH 20	2			•		573170	
	RH 25	2			•		573154	
	RH 32	2			•		573156	
REHAU RAUTHERM S (REHAU HAS)	RH 17	2			•		573168	
	RH 20	2			•		573170	
	RH 25	2			•		573154	
	RH 32	2			•		573156	
	REHAU RAUTITAN PX/MX/SX/RX/ gas/sprinkler	RE 16	2			•		573160
RE 20		2			•		573162	
RE 25		2			•		573172	
RE 32		2			•		573178	
RE 40		2			•		573176	
REHAU (GBR) EVERLOC	RH 16	2			•		573166	
	RH 20	2			•		573170	
	RH 25	2			•		573154	
	RH 32	2			•		573156	
REVEL	RV 16	2			•		573400	
	RV 20	2			•		573402	
	RV 25	2			•		573404	
	RV 32	2			•		573406	
Riquier à glissement	UNI 12	2	•	•	•	•	573630	
	UNI 16	2	•	•	•	•	573632	
	UNI 20	2	•	•	•	•	573636	
	UNI 25	2	•	•	•	•	573640	
	UNI 32	2	•	•	•	•	573644	
	UNI T/L** Basic 25*	1	•	•	•	•	573646	
ROTEX	RO 12	2			•		573180	
	RO 16	2			•		573184	
	RO 20	2			•		573186	
	RO 25	2			•		573188	
	RO 32	2			•		573190	
	Seppelfricke SD Sistemi Italia Sylver	RE 16	2			•		573160
		RE 20	2			•		573162
RE 25		2			•		573172	
RE 32		2			•		573178	
RO 16		2			•		573184	
Seppelfricke SD Sistemi Italia Neroflex	RE 16	2			•		573160	
	RE 20	2			•		573162	
	RE 25	2			•		573172	
	RE 32	2			•		573178	
	RO 16	2			•		573184	
SURE HISPANIA SURE-CAS	UNI 12	2	•	•	•	•	573630	
	UNI 16	2	•	•	•	•	573632	
	UNI 20	2	•	•	•	•	573636	
	UNI 25	2	•	•	•	•	573640	
	UNI 32	2	•	•	•	•	573644	
	UNI T/L** Basic 20*	1	•	•	•	•	573646	
	Basic 25*	2	•	•	•	•	573616	
Basic 32*	2	•	•	•	•	573628		
TECE TECEflex	TC 12/14/16	2			•		573360	
	TC 18/20	2			•		573364	
	TC 25	2			•		573367	
	TC 32	2			•		573370	
	TIEMME Assialpex	IV 16	3			•		573320
IV 20		3			•		573325	
IV 25		3			•		573330	
Velta Eurojauge	UNI 12	2	•	•	•	•	573630	
	UNI 16	2	•	•	•	•	573632	
	UNI 20	2	•	•	•	•	573636	
	UNI 25	2	•	•	•	•	573640	
	UNI T/L** Basic 25*	1	•	•	•	•	573646	
Würth PRINETO	IV 16	3			•		573320	
	IV 20	3			•		573325	
	IV 25	3			•		573330	
	IV 32	3			•		573335	

</



REMS
ArcPress 30

REMS TECHNOLOGY
LI-ION 22V



REMS Ax-Press 30

Cordless axial press

Compact, handy electric tool for producing compression sleeve joints with crimping sleeve. For trade and industry. For the building site and the workshop.
Li-Ion 22V Technology.

Axial compression Ø 12–32 mm

REMS Ax-Press 30 Li-Ion – up to Ø 32 mm.
Ultra light, ultra small, ultra handy, ultra fast.
Li-Ion 22V Technology for 50% more pressings¹⁾

Compression heads for all common systems

Complete assortment of REMS compression heads for all common compression sleeve systems with crimping sleeve. High-grade compression heads in forged and specially hardened steel. The REMS compression heads are system-specific and correspond to the respective compression sleeve system. Thus perfect system-conformity, safe jointing.

Design

Compact, handy, light. Drive unit with battery only 4.4 kg. Can be used anywhere, free hand, over head, in confined spaces. Optimum weight distribution for one-hand operation. Drive unit with inserted compression heads can be put down on the battery ready to pick up. Ergonomically designed housing with soft grip. Integrated LED work light for illuminating the work place. Compression heads and expander heads quickly interchangeable, without tools. Secure spring lock seating of compression heads. Electronic charging status check with flat battery protection and charging status indicator with 2-coloured LED.

Drive

High pressing force for perfect pressing in seconds, e.g. Ø 26 mm in only 5 s. Powerful electro-hydraulic drive, eccentric reciprocating pump with robust planetary gear. Powerful electro-hydraulic drive with powerful battery motor 21.6 V, 380 W output, robust planetary gear, eccentric reciprocating pump and compact high power hydraulic system. Safety tip switch.

Li-Ion 22V Technology

Highly resistant Li-Ion 21.6 V batteries with 1.5 or 2.5 Ah capacity for long service life. Powerful and light. Li-Ion 21.6 V batteries for 50% more pressings¹⁾ than Li-Ion 14.4 V batteries. Graduated charging state display with coloured LEDs. Total discharge and overload protection with single cell monitoring. Temperature monitoring during the charging process. Operating temperature range – 10 to + 60 °C. No memory effect for maximum battery power. Rapid charger for short charging times.

Supply format

REMS Ax-Press 30 Basic-Pack. Cordless axial press for producing compression sleeve joints with crimping sleeve Ø 12–32 mm. Electro-hydraulic drive with powerful battery motor 21.6 V, 380 W, robust planetary gear, eccentric reciprocating pump and compact high power hydraulic system, safety tip switch. Integrated LED work light. Battery Li-Ion 21.6 V, 1.5 Ah, rapid charger Li-Ion 230 V, 50–60 Hz, 70 W. In sturdy steel case.

	Art.-No.	
	573018	

Accessories

Description	Art.-No.	
REMS Ax-Press 30 Li-Ion drive unit, without battery	573006	
Battery Li-Ion 21.6 V, 1.5 Ah	571570	
Battery Li-Ion 21.6 V, 2.5 Ah	571571	
Rapid charger Li-Ion 230 V, 50–60 Hz, 70 W	571575	
Steel case with insert	573282	

REMS compression heads

Compression sleeve system	Compression head	Art.-No.	
Brasstech Raptor/ Metalpex/ Raptor 2/ MULTitermoSAN	ME 14 (pack of 2)	573100	
	ME 16 (pack of 2)	573102	
	ME 20 (pack of 2)	573106	
	ME 26 (pack of 2)	573108	
	ME 32 (pack of 2)	573110	
General Fittings Serie 5400	ME 14 (pack of 2)	573100	
	ME 16 (pack of 2)	573102	
	ME 20 (pack of 2)	573106	
	ME 26 (pack of 2)	573108	
	ME 32 (pack of 2)	573110	
Georg Fischer pfc ALUPEX-EXPRESS/ Alupex Gas System	ME 14 (pack of 2)	573100	
	ME 16 (pack of 2)	573102	
	ME 20 (pack of 2)	573106	
	ME 26 (pack of 2)	573108	
	ME 32 (pack of 2)	573110	



e.g.
Brasstech,
General Fittings,
Georg Fischer pfc

German Quality Product

Tested by electrosuisse >>>



REMS Ax-Press 40

Cordless axial press

Compact, handy electric tool for producing compression sleeve joints with crimping sleeve. For trade and industry. For the building site and the workshop.

Axial compression \varnothing 12–32 mm

REMS Ax-Press 40 Li-Ion – up to \varnothing 32 mm.

Compression heads for all common systems

Complete assortment of REMS compression heads for all common compression sleeve systems with crimping sleeve. High-grade compression heads in forged and specially hardened steel. The REMS compression heads are system-specific and correspond to the respective compression sleeve system. Thus perfect system-conformity, safe jointing.

Design

Compact, handy, light. Drive unit with battery only 5.5 kg. Vertically from the drive unit located pressing device for seating the compression heads (**Patent US 6,415,641**). Works anywhere, free-hand, overhead, in confined areas. Optimum weight distribution for single-hand operation. Ergonomically shaped housing with recessed grip. Integrated LED work light for illuminating the work place. Swivelling compression device for working in confined area. Compression heads and expander heads quickly interchangeable, without tools. Secure spring lock seating of compression heads. For battery and corded operation. Electronic charging status check with flat battery protection and charging status indicator with 2-coloured LED.

Drive

Enormous pressing force for fast and perfect jointing. Powerful electro-hydraulic drive, eccentric reciprocating pump with robust planetary gear. Powerful electro-hydraulic drive with powerful battery motor 14.4 V, 380 W output, robust planetary gear, eccentric reciprocating pump and compact high power hydraulic system. Safety tip switch.

Battery or mains operation

Li-Ion PLUS technology. Highly resistant Li-Ion 14.4 V battery with 3.0 Ah capacity, for long service life. Powerful and light. Total discharge and overload protection with single cell monitoring. Temperature monitoring during the charging process. Operating temperature range – 10 to + 60 °C. No memory effect for maximum battery power. Rapid charger for short charging times. Li-Ion 230 V voltage supply for mains operation instead of Li-Ion 14.4 V battery, as accessory.

Supply format

REMS Ax-Press 40 Set. Cordless axial press for producing compression sleeve joints with crimping sleeve \varnothing 12–32 mm. Electro-hydraulic drive with powerful battery motor 14.4 V, 380 W, robust planetary gear, eccentric reciprocating pump and compact high power hydraulic system, safety tip switch, swivelling compression device. Integrated LED work light. Battery Li-Ion 14.4 V, 3.0 Ah, rapid charger Li-Ion/Ni-Cd 230 V, 50–60 Hz, 65 W. REMS compression heads corresponding to the respective compression sleeve system. In sturdy steel case.

Description	Compression sleeve system	Art.-No.
Set ME 16-20-26	Brasstech Raptor/Metalpex/ Raptor 2/MULTItermoSAN, General Fittings Serie 5400, Georg Fischer pfcI ALUPEX- EXPRESS/Alupex Gas-System	573061 573064
Set LR 20-22-25	Logstor	573064
Basic-Pack	without compression heads	573060

Accessories

Description	Art.-No.
REMS Ax-Press 40 Li-Ion drive unit, without battery	573006
Battery Li-Ion 14.4 V, 3.0 Ah	571555
Rapid charger Li-Ion/Ni-Cd 230 V, 50–60 Hz, 65 W	571560
Voltage supply Li-Ion 230 V for mains operation instead of battery Li-Ion 14.4 V.	571565
Steel case with insert	573282
REMS cordless LED lamp see page 95	175200

REMS compression heads

Compression sleeve system	Compression head	Art.-No.
Brasstech Raptor/ Metalpex/ Raptor 2/ MULTItermoSAN	ME 14 (pack of 2)	573100
	ME 16 (pack of 2)	573102
	ME 20 (pack of 2)	573106
	ME 26 (pack of 2)	573108
	ME 32 (pack of 2)	573110
General Fittings Serie 5400	ME 14 (pack of 2)	573100
	ME 16 (pack of 2)	573102
	ME 20 (pack of 2)	573106
	ME 26 (pack of 2)	573108
	ME 32 (pack of 2)	573110
Georg Fischer pfcI ALUPEX-EXPRESS/ Alupex Gas System	ME 14 (pack of 2)	573100
	ME 16 (pack of 2)	573102
	ME 20 (pack of 2)	573106
	ME 26 (pack of 2)	573108
	ME 32 (pack of 2)	573110



e.g.
Brasstech,
General Fittings,
Georg Fischer pfcI,
Logstor

Patent
US 6,415,641

German Quality Product

Tested by electrosuisse >>>













REMS compression heads

Compression sleeve system	Compression head	Art.-No.
Logstor	ME 16 (pack of 2)	573102
	LR 20 (pack of 2)	573430
	LR 22 (pack of 2)	573432
	LR 25 (pack of 2)	573434
	LR 28 (pack of 2)	573436
	LR 32 (pack of 2)	573438

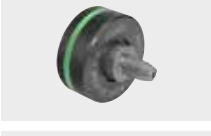
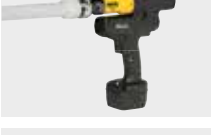

Expanding Extracting

	Hand tube expander Cu	176
	Expander head Cu	176
	Cordless pipe expander Cu	177
	One-hand pipe expander	178
	Hand tube expander P	178
	Cordless pipe expander P	179
	Expander head Cu P	181
	Cordless pipe expander Q&E	182
	Electro-hydraulic pipe expander Q&E	183
	Hand tube extractor	184
	Electric tube extractor Electric tube expander	185

REMS Akku-Ex-Press Cu ACC

Cordless pipe expander with automatic return

Compact, handy electric tool for fast, easy expanding and calibration of pipes for pipe installation without fittings. For battery and corded operation. For trade and industry. For the building site and the workshop.

Soft copper tubes $s \leq 1.5$ mm	$\varnothing 8-42$ mm $\varnothing \frac{3}{8}-1\frac{3}{4}$ "
Soft aluminium tubes, soft precision steel tubes $s \leq 1.2$ mm	$\varnothing 8-42$ mm $\varnothing \frac{3}{8}-1\frac{3}{4}$ "
Soft stainless steel tubes $s \leq 1$ mm	$\varnothing 8-42$ mm $\varnothing \frac{3}{8}-1\frac{3}{4}$ "

REMS Akku-Ex-Press Cu ACC – fast, easy electric expanding up to $\varnothing 42$ mm. With automatic return.

Cost advantage

Pipe installation without fittings. No costs for fittings, storage, procurement. Savings in soldering joints, soldering material and working hours. Using up pipe pieces to provide sockets.

Expander heads for all common systems

Quick-change. Extra long expander heads result in extra long sockets for perfect pipe connections according to DVGW. Special neck at expander head specially for calibration of deformed pipe ends.

Execution

Compact, handy, light. Drive unit with battery only 2.3 kg. Drive machine only 30 cm long. Works anywhere, free-hand, overhead, in confined areas. Optimum weight distribution for single-hand operation. Ergonomically shaped housing with recessed grip. For battery and corded operation. Integrated LED work light for illuminating the work place. Electronic charging status check with flat battery protection and charging status indicator with 2-coloured LED. Conical expanding mandrel (conical angle 18°) for even concentric expanding. Extra long sockets, spring-loaded return of mandrel.

Drive

High pressing force for fast, perfect expanding. Powerful electro-hydraulic drive with automatic return (ACC), with powerful battery motor 14.4 V, 380 W, robust planetary gear, eccentric reciprocating pump and compact high power hydraulic system. Safety tip switch.

Battery or mains operation

Li-Ion PLUS technology. Highly resistant Li-Ion 14.4 V battery with 1.5 or 3.0 Ah capacity for long service life. Powerful and light. Total discharge and overload protection with single cell monitoring. Temperature monitoring during the charging process. Operating temperature range -10 to $+60$ °C. No memory effect for maximum battery power. Rapid charger for short charging times. Li-Ion 230 V voltage supply for mains operation instead of Li-Ion 14.4 V battery, as accessory.



German Quality Product

Tested by electrosuisse



Supply format

REMS Akku-Ex-Press Cu ACC Basic-Pack. Cordless pipe expander for fast, easy expanding and calibration of pipes. Soft copper pipes $\varnothing 8-42$ mm, $\varnothing \frac{3}{8}-1\frac{3}{4}$ ", $s \leq 1.5$ mm, soft aluminium pipes, soft precision steel pipes, $\varnothing 8-42$ mm, $\varnothing \frac{3}{8}-1\frac{3}{4}$ ", $s \leq 1.2$ mm, soft stainless steel pipes $\varnothing 8-42$ mm, $\varnothing \frac{3}{8}-1\frac{3}{4}$ ", $s \leq 1$ mm. Electro-hydraulic drive with automatic retraction, with powerful battery motor 14.4 V, 420 W, robust planetary gear, eccentric reciprocating pump and compact high power hydraulic system. Safety tip switch. Integrated LED work light. Battery Li-Ion 14.4 V, 1.5 Ah, rapid charger Li-Ion/Ni-Cd 230 V, 50–60 Hz, 65 W. Without expander heads. In sturdy steel case.

	Art.-No.
	575016

Other voltages on request.

Accessories

Description	Art.-No.
Expander heads Cu see page 176.	
REMS Akku-Ex-Press Cu ACC drive unit, without battery	575006
Battery Li-Ion 14.4 V, 1.5 Ah	571545
Battery Li-Ion 14.4 V, 3.0 Ah	571555
Rapid charger Li-Ion/Ni-Cd 230 V, 50–60 Hz, 65 W	571560
Voltage supply Li-Ion 230 V for mains operation instead of battery Li-Ion 14.4 V.	571565
Steel case with insert	578290
REMS cordless LED lamp see page 95	175200



REMS Ex-Press H

One-hand pipe expander

Robust, compact quality tool for expanding tubes.
For one-hand operation.

PEX tubes Serie S 5 according to ISO 4065 Ø 12–40 mm

REMS Ex-Press H – universal up to Ø 40 mm.

Robust, compact quality tool. Super light, only 0.7 kg.
Stepped mandrels for expanding several tube dimensions, no tool change required.
Torsion-free, leveraged expander tool for effortless expanding.
For one-hand operation.

Supply format

REMS Ex-Press H. One-hand pipe expander for PEX tubes Serie S 5 according to ISO 4065 Ø 12–40 mm. In a carton.

	Art.-No.	
	150550	



German Quality Product



REMS Ex-Press P

Hand tube expander

Proven quality tool for expanding tubes.

Plastic tubes, multi-layer composite tubes Ø 12–32 mm

REMS Ex-Press P – for expanding tubes. Conical mandrel for even and concentric expanding.

Design

Robust quality tool. Torsion-free, power-transmitting expander levers with ergonomically designed handles, for effortless expanding. Conical mandrel (taper angle 18°) for even and concentric expanding. Long mandrel guidance, spring-loaded mandrel release.

Expander heads for all common systems

Complete assortment of REMS expander heads P for all common compression sleeve systems (page 181). Quickly interchangeable, without tools. The REMS expander heads are system-specific and comply with the requirements of the respective compression sleeve system. Thus perfect system-conformity, exact expanding.

Supply format

REMS Ex-Press P Set. Hand tube expander for plastic tubes and multi-layer composite tubes Ø 12–32 mm. REMS Ex-Press P. Expander heads P for tubes in mm. In sturdy steel case.

Description	Compr. sleeve system	Art.-No.
Set AT P 16-20-25	aquatherm SHT PB/ PE-Rohre	150021
Set AT V 16-20-25	aquatherm SHT Mehrschicht-Metall- verbundrohre	150033
Set IV 16-20-25	IVT PRINETO, Würth PRINETO	150026
Set RH HAS 17-20-25	REHAU RAUTHERM S (REHAU HAS)	150027
Set RH HIS 16-20-25	REHAU RAUTITAN flex/gas flex/pink/his, General Fittings Serie 3400 PEX, Seppelfricke SD Sistemi Italia	150028
Set RH MKV 16-20-25	Neroflex/Sylver REHAU RAUTITAN stabil/gas stabil, General Fittings Serie 3400 PEX/AL/PEX	150022
Set RH 16-20-25	REHAU RAUTHERM (série S 5), REHAU (GBR) EVERLOC	150029
Set RO VA 16-20-25	ROTEX	150023
Set TC 16-18/20-25	TECE TECEflex, General Fittings Serie 3700 PEX	150025

System-specific and/or national differences of the wall thickness (s) of tubes need to be considered selecting expander heads, see table page 181.

Accessories

Description	Art.-No.
Expander heads P see page 181.	
Expander drive REMS Ex-Press P (taper angle 18°)	150510
Steel case with insert	150600



German Quality Product

e.g.
aquatherm,
General Fittings,
IVT,
REHAU,
REVEL,
ROTEX,
Seppelfricke,
TECE,
Würth



REMS Akku-Ex-Press P ACC

Cordless pipe expander with automatic return

Compact, handy power tool with automatic return for fast, easy expansion of pipes. For battery and corded operation. For trade and industry. For the building site and the workshop.

Plastic tubes, multi-layer composite tubes Ø 12–40 mm

REMS Akku-Ex-Press P ACC – Fast, easy electric expanding up to Ø 40 mm. With automatic return. Conical mandrel for even and concentric expanding.

Expander heads

Quickly interchangeable, without tools. The REMS expander heads are system-specific and comply with the requirements of the respective compression sleeve system. Thus perfect system-conformity, exact expanding.

Execution

Compact, handy, light. Drive unit with battery only 2.3 kg. Drive machine only 30 cm long. Works anywhere, free-hand, overhead, in confined areas. Optimum weight distribution for single-hand operation. Ergonomically shaped housing with recessed grip. Integrated LED work light for illuminating the work place. For battery and corded operation. Electronic charging status check with flat battery protection and charging status indicator with 2-coloured LED. Conical expanding mandrel (conical angle 18°) for even centric expanding. Long mandrel guide, spring-loaded mandrel recoil.

Drive

High pressing force for fast, perfect expanding. Powerful electro-hydraulic drive with automatic return (ACC), with powerful battery motor 14.4 V, 380 W, robust planetary gear, eccentric reciprocating pump and compact high power hydraulic system. Safety tip switch.

Battery or mains operation

Li-Ion PLUS technology. Highly resistant Li-Ion 14.4 V battery with 1.5 or 3.0 Ah capacity for long service life. Powerful and light. Total discharge and overload protection with single cell monitoring. Temperature monitoring during the charging process. Operating temperature range -10 to +60 °C. No memory effect for maximum battery power. Rapid charger for short charging times. Li-Ion 230 V voltage supply for mains operation instead of Li-Ion 14.4 V battery, as accessory.



German Quality Product

Tested by electrosuisse >>



Supply format

REMS Akku-Ex-Press P ACC Basic-Pack. Cordless pipe expander for fast expanding of plastic and multilayer composite pipes Ø 12–40 mm. Electro-hydraulic drive with automatic retraction, with powerful battery motor 14.4 V, 420 W, robust planetary gear, eccentric reciprocating pump and compact high power hydraulic system. Safety tip switch. Integrated LED work light. Battery Li-Ion 14.4 V, 1.5 Ah, rapid charger Li-Ion/Ni-Cd 230 V, 50–60 Hz, 65 W. Without expander heads. In sturdy steel case.

	Art.-No.	
	575018	

Other voltages on request.

Accessories

REMS expander heads P

Quickly interchangeable, without tools. The REMS expander heads are system-specific and comply with the requirements of the respective compression sleeve system. Thus perfect system-conformity, exact expanding. Drive through expander REMS Ex-Press P (taper angle 18°), REMS Akku-Ex-Press P ACC and through suitable expanders of other makes.

Compression sleeve system	Expander head P Ø × s	Art.-No.
ROTEX	RO VA 12 × 2,0	150814
	RO VA 16 × 2,2	150851
	RO VA 20 × 2,8	150890
	RO VA 25 × 3,5	150918
	RO VA 32 × 4,4	150919
Description		Art.-No.
REMS Akku-Ex-Press P ACC drive unit, without battery		575008
Battery Li-Ion 14.4 V, 1.5 Ah		571545
Battery Li-Ion 14.4 V, 3.0 Ah		571555
Rapid charger Li-Ion/Ni-Cd 230 V, 50–60 Hz, 65 W		571560
Voltage supply Li-Ion 230 V for mains operation instead of battery Li-Ion 14.4 V.		571565
Steel case with insert		578290
REMS cordless LED lamp see page 95		175200

e.g. ROTEX



REMS Akku-Ex-Press P

Cordless pipe expander with switch-off signal

Compact, handy power tool with switch-off signal for fast, easy expansion of pipes. For battery and corded operation. For trade and industry. For the building site and the workshop.

Plastic tubes,
multi-layer composite tubes Ø 12–40 mm

REMS Akku-Ex-Press P – Fast, easy electric expanding up to Ø 40 mm. Conical mandrel for even and concentric expanding.

Expander heads for all common systems

Complete assortment of REMS expander heads P for all common compression sleeve systems (page 181). Quickly interchangeable, without tools. The REMS expander heads are system-specific and comply with the requirements of the respective compression sleeve system. Thus perfect system-conformity, exact expanding.

Execution

Compact, handy, light. Drive unit with battery only 2.3 kg. Drive machine only 30 cm long. Works anywhere, free-hand, overhead, in confined areas. Optimum weight distribution for single-hand operation. Ergonomically shaped housing with recessed grip. Integrated LED work light for illuminating the work place. For battery and corded operation. Electronic charging status check with flat battery protection and charging status indicator with 2-coloured LED. Conical expanding mandrel (conical angle 18°) for even centric expanding. Long mandrel guide, spring-loaded mandrel recoil.

Drive

High pressing force for fast, perfect expanding. Powerful electro-hydraulic drive with powerful battery motor 14.4 V, 380 W, robust planetary gear, eccentric reciprocating pump and compact high power hydraulic system. Safety tip switch. Acoustic signal after successfully finished expansion. The expanding heads stay open until switching over to return. Read and follow the installation and assembly instructions of the system provider/manufacturer.

Battery or mains operation

Li-Ion technology. Highly resistant Li-Ion 14.4 V battery with 1.5 or 3.0 Ah capacity for long service life. Powerful and light. Total discharge and overload protection with single cell monitoring. Temperature monitoring during the charging process. Operating temperature range –10 to +60 °C. No memory effect for maximum battery power. Rapid charger for short charging times. Li-Ion 230 V voltage supply for mains operation instead of Li-Ion 14.4 V battery, as accessory.



German Quality Product

Tested by electrosuisse >>



Supply format

REMS Akku-Ex-Press P Basic-Pack. Cordless pipe expander for fast expanding of plastic and multilayer composite pipes Ø 12–40 mm. Electro-hydraulic drive with switch-off signal, with powerful battery motor 14.4 V, 420 W, robust planetary gear, eccentric reciprocating pump and compact high power hydraulic system. Safety tip switch. Integrated LED work light. Battery Li-Ion 14.4 V, 1.5 Ah, rapid charger Li-Ion/Ni-Cd 230 V, 50–60 Hz, 65 W. Without expander heads. In sturdy steel case.

	Art.-No.	
	575019	

Other voltages on request.

Accessories

Description	Art.-No.
Expander heads P see page 181.	
REMS Akku-Ex-Press P drive unit, without battery	575009
Battery Li-Ion 14.4 V, 1.5 Ah	571545
Battery Li-Ion 14.4 V, 3.0 Ah	571555
Rapid charger Li-Ion/Ni-Cd 230 V, 50–60 Hz, 65 W	571560
Voltage supply Li-Ion 230 V for mains operation instead of battery Li-Ion 14.4 V.	571565
Steel case with insert	578290
REMS cordless LED lamp see page 95	175200

e.g.
aquatherm,
General Fittings,
IVT,
REHAU,
REVEL,
TECE,
TIEMME,
Würth



REMS expander heads P

Accessories for REMS Ex-Press P,
REMS Akku-Ex-Press P and other makes

REMS expander heads P

Complete assortment of REMS expander heads P for all common compression sleeve systems. Quickly interchangeable, without tools. The REMS expander heads are system-specific and comply with the requirements of the respective compression sleeve system. Thus perfect system-conformity, exact expanding. Drive through expander REMS Ex-Press P (taper angle 18°), REMS Akku-Ex-Press P and through suitable expanders of other makes.

Compression sleeve system	Expander head P Ø × s	Art.-No.	
aquatherm SHT PB/PE-RT-Rohre	AT P 14 × 2,0	150828	
	AT P 16 × 2,0	150842	
	AT P 18 × 2,0	150873	
	AT P 20 × 2,0	150882	
	AT P 25 × 2,3	150912	
aquatherm SHT Mehrschicht- Metallverbundrohre (MVR)	AT V 16 × 2,4	150843	
	AT V 20 × 2,4	150883	
	AT V 25 × 2,7	150913	
	AT V 32 × 3,2	150957	
	AT V 40 × 3,5	150958	
General Fittings Serie 3400 PEX	RH HIS 16 × 2,2	150849	
	RH HIS 20 × 2,8	150888	
	RH HIS 25 × 3,5	150916	
	RH HIS 32 × 4,4	150945	
General Fittings Serie 3400 PEX/AL/PEX	RH MKV 16,2 × 2,6	150858	
	RH MKV 20 × 2,9	150897	
	RH MKV 25 × 3,7	150926	
	RH MKV 32 × 4,7	150952	
General Fittings Serie 3700 PEX	TC 16	150855	
	TC 18/20	150894	
	TC 25	150923	
	TC 32	150950	
General Fittings Serie 3700 PEX/AL/PEX	TC 16	150855	
	TC 18/20	150894	
	TC 25	150923	
	TC 32	150950	
IVT PRINETO	IV 16 × 2,2/2,8	150845	
	IV 20 × 2,8/3,4	150885	
	IV 25 × 3,5/4,0	150914	
	IV 32 × 4,4/4,9	150943	
REHAU RAUTHERM (série S 5)	RH 12 × 1,1	150812	
	RH 16 × 1,5	150846	
	RH 20 × 1,9	150886	
	RH 25 × 2,3 (RH HAS 25 × 2,3)	150915	
	RH 32 × 2,9 (RH HAS 32 × 2,9)	150944	
REHAU RAUTHERM S (REHAU HAS)	RH HAS 17 × 2,0	150868	
	RH HAS 20 × 2,0	150887	
	RH HAS 25 × 2,3	150915	
	RH HAS 32 × 2,9	150944	
REHAU RAUTITAN flex/ RAUTITAN gas flex/ RAUTITAN pink/ RAUTITAN his	RH HIS 16 × 2,2	150849	
	RH HIS 20 × 2,8	150888	
	RH HIS 25 × 3,5	150916	
	RH HIS 32 × 4,4	150945	
	RH HIS 40 × 5,5	150946	
REHAU RAUTITAN stabil/ RAUTITAN gas stabil	RH MKV 16,2 × 2,6	150858	
	RH MKV 20 × 2,9	150897	
	RH MKV 25 × 3,7	150926	
	RH MKV 32 × 4,7	150952	
	RH MKV 40 × 6,0	150947	
REHAU (GBR) EVERLOC	RH 16 × 1,5	150846	
	RH 20 × 1,9	150886	
	RH 25 × 2,3 (RH HAS 25 × 2,3)	150915	
	RH 32 × 2,9 (RH HAS 32 × 2,9)	150944	
REVEL	RH HIS 16 × 2,2	150849	
	RH HIS 20 × 2,8	150888	
	RH HIS 25 × 3,5	150916	
	RH HIS 32 × 4,4	150945	
Seppelfricke SD Sistemi Italia Neroflex/Sylver	RH HIS 16 × 2,2	150849	
	RH HIS 20 × 2,8	150888	
	RH HIS 25 × 3,5	150916	
	RH HIS 32 × 4,4	150945	
TECE TECEflex	TC 12/14	150826	
	TC 16	150855	
	TC 18/20	150894	
	TC 25	150923	
	TC 32	150950	
TIEMME Assialpex	IV 16 × 2,2/2,8	150845	
	IV 20 × 2,8/3,4	150885	
	IV 25 × 3,5/4,0	150914	
Würth PRINETO	IV 16 × 2,2/2,8	150845	
	IV 20 × 2,8/3,4	150885	
	IV 25 × 3,5/4,0	150914	
	IV 32 × 4,4/4,9	150943	

System-specific and/or national differences of the wall thickness (s) of tubes need to be considered selecting expander heads. REMS expander heads P for additional compression sleeve systems on request.

Choose expander heads yourself!

Search for the required compression sleeve system in the table below and select the correct expander heads.



German Quality Product

REMS Akku-Ex-Press Q & E ACC

Cordless pipe expander with automatic return

Compact, handy electric tool for fast, easy expanding of tubes/coil of the Uponor Quick & Easy system. For battery and corded operation. For trade and industry. For the building site and the workshop.

Expanding Ø 16–40 mm

REMS Akku-Ex-Press Q&E ACC – Fast, easy electric expanding up to Ø 40 mm. Compact, handy, light. With automatic return. For Uponor Quick & Easy.

Expander heads

Large expanding capacity up to Ø 40 mm. Automatic, gradual expansion until reaching the given end position which is determined by the expander head. Use of original Uponor Quick & Easy expander heads, manual and hydraulic.

Execution

Compact, handy, light. Drive unit with battery only 2.3 kg. Drive machine only 30 cm long. Works anywhere, free-hand, overhead, in confined areas. Optimum weight distribution for single-hand operation. Ergonomically shaped housing with recessed grip. Integrated LED work light for illuminating the work place. For battery and corded operation. Electronic charging status check with flat battery protection and charging status indicator with 2-coloured LED.

Drive

High pressing force for fast, perfect expanding. Powerful electro-hydraulic drive with automatic return (ACC), with powerful battery motor 14.4 V, 380 W, robust planetary gear, eccentric reciprocating pump and compact high power hydraulic system. Safety tip switch.

Battery or mains operation

Li-Ion PLUS technology. Highly resistant Li-Ion 14.4 V battery with 1.5 or 3.0 Ah capacity for long service life. Powerful and light. Total discharge and overload protection with single cell monitoring. Temperature monitoring during the charging process. Operating temperature range –10 to +60 °C. No memory effect for maximum battery power. Rapid charger for short charging times. Li-Ion 230 V voltage supply for mains operation instead of Li-Ion 14.4 V battery, as accessory.



German Quality Product

Tested by electrosuisse >>



Supply format

REMS Akku-Ex-Press Q&E ACC Basic-Pack. Cordless tube expander for expanding tubes/coils of the Uponor Quick & Easy system Ø 16–40 mm, Ø ½–1½". Electro-hydraulic drive with automatic retraction, with powerful battery motor 14.4 V, 420 W, robust planetary gear, eccentric reciprocating pump and compact high power hydraulic system. Safety tip switch. Integrated LED work light. Battery Li-Ion 14.4 V, 1.5 Ah, rapid charger Li-Ion/Ni-Cd 230 V, 50–60 Hz, 65 W. Without expander heads. In sturdy steel case.

	Art.-No.	
	575015	

Note assembly instructions of system supplier. Battery tube expander for other systems on request. Other voltages on request.

Accessories

Description	Art.-No.	
REMS Akku-Ex-Press Q&E ACC Li-Ion drive unit, without battery	575005	
Battery Li-Ion 14.4 V, 1.5 Ah	571545	
Battery Li-Ion 14.4 V, 3.0 Ah	571555	
Rapid charger Li-Ion/Ni-Cd 230 V, 50–60 Hz, 65 W	571560	
Voltage supply Li-Ion 230 V for mains operation instead of battery Li-Ion 14.4 V.	571565	
Steel case with insert	578290	
REMS cordless LED lamp see page 95	175200	



REMS Power-Ex-Press Q & E ACC

Electro-hydraulic pipe expander with automatic return

Compact, handy electric tool for fast, easy expanding of tubes/coils of the Uponor Quick & Easy system. For trade and industry. For the building site and the workshop.

Expanding	Ø 16–63 mm Ø ½–2" s ≤ 5,8 mm
-----------	------------------------------------

REMS Power-Ex-Press Q&E ACC – Fast, easy electric expanding up to Ø 63 mm. With automatic return. For Uponor Quick & Easy.

Expander heads

Large expanding capacity up to Ø 63 mm. Automatic, gradual expansion until reaching the given end position which is determined by the expander head. Use of original Uponor Quick & Easy expander heads, Ø 16–63 mm, Ø ½–2", 2" expanding heads. Expanding device for holding the original Uponor Quick & Easy 16–40 mm, ½–1½", expanding heads as an accessory.

Execution

Compact, robust, job site-proven. Small in size, slender design, drive unit only 5.3 kg. Works anywhere, free-hand, overhead, in confined areas. Ideal weight distribution for single handed operation. Ergonomically designed housing with recessed grip.

Drive

High pressing force for fast, perfect expanding. Powerful electro-mechanical drive with automatic return (ACC), with proven universal motor, 450 W, maintenance-free gear with safety slipping clutch and in-feed system with machine screw spindle. Safety tip switch.



German Quality Product

Tested by electrosuisse >>

Supply format

REMS Power-Ex-Press Q&E ACC Basic-Pack. Electro-hydraulic pipe expander for expanding tubes/coils of the Uponor Quick & Easy system Ø 16–63 mm, Ø ½–2", s ≤ 5,8 mm. Electro-hydraulic drive with automatic retraction, with proven universal motor 230 V or 110 V, 50–60 Hz, 450 W, robust planetary gear, eccentric reciprocating pump and compact high power hydraulic system. Safety tip switch. Expanding device 54–63 mm, 2". Without expander heads. In a carton.

	Art.-No.	
	575017	

Note assembly instructions of system supplier. Battery tube expander for other systems on request. Other voltages on request.

Accessories

Description	Art.-No.	
Adapter 16–40 mm, ½–1½" for fitting the original expanding heads Uponor Quick & Easy 16–40 mm, ½–2".	575100	
Steel case with insert	575278	



REMS Hurrican H

Hand tube extractor

Economic manual tool for efficiently making T-branches for pipe installations without fittings.

Hard and soft copper tubes \varnothing 10–22 mm
 \varnothing $\frac{3}{8}$ – $\frac{7}{8}$ "
 $s \leq 1.5$ mm

REMS Hurrican H – for making T-branches yourself. Inexpensive. Also on tubes already installed.

System advantage

Only **one** type of extractor tools for REMS Hurrican H, REMS Hurrican and REMS Twist/Hurrican. Simple, inexpensive storage. No confusion possible.

Cost advantage

No costs for T-pieces, storage, procurement. Savings in soldering joints, pressing joints and working hours. Higher safety by fewer tube joints.

Design

Compact, handy, light. Can be used anywhere, free-hand, on pipes already installed. Drill head for exact drilling start without centre punching, drilling depth stop according to size of the T-outlet. Limitation of insertion depth to avoid obstruction by using the dimpling pliers. Handy gripping tongs for fixing the tool holder on the pipe, as an accessory.

Drill head drive

Drive with conventional electric drill.

Extractor tools

Special design of extractor tools facilitate even and smooth material deformation without burrs and notches. Therefore no secondary treatment required.

Tool holder drive

With standard ratchet and hexagon socket 11 mm or with spanner. Upgrade to electric pipe neck expander by buying the REMS Twist/Hurrican drive machine.



German Quality Product

Supply format

REMS Hurrican H Set. Hand tube extractor for hard and soft copper tubes \varnothing 10–22 mm, \varnothing $\frac{3}{8}$ – $\frac{7}{8}$ ", $s \leq 1.5$ mm. Tool holder, drill head, dimpling pliers, lubricant. Extractor tools for tubes in mm or inch. In sturdy case.

Description	Art.-No.
Set 12-15-18-22	151003
Set 12-14-16-18-22	151004
Set $\frac{3}{8}$ - $\frac{1}{2}$ - $\frac{5}{8}$ - $\frac{3}{4}$ - $\frac{7}{8}$ "	151005



Accessories

Description	Tubes \varnothing mm/inch	Art.-No.
Extractor tool	10	151105
	12	151110
	14	151120
	15	151125
	16	151130
	18	151140
	20	151145
	22	151150
	$\frac{3}{8}$ "	151155
	$\frac{1}{2}$ "	151160
	$\frac{5}{8}$ "	151165
$\frac{3}{4}$ "	151170	
$\frac{7}{8}$ "	151175	
REMS Twist/Hurrican drive unit with stabiliser		151401
Grip wrench for clamping the tool holder		076117
Tool holder		151200
Drill head		151210
Dimpling pliers		151230
Ratchet $\frac{1}{2}$"		074021
Hexagon socket 11 mm		074041
Lubricant (tin)		151240
Case with inlay		151618



REMS Hurrican

Electric tube extractor

Powerful, compact electric tool for efficient machining of T-branches of hard and soft tubes for tube installations without fittings.

Hard and soft copper tubes \varnothing 10–22 mm
 \varnothing $\frac{3}{8}$ – $\frac{7}{8}$ "
 $s \leq 1.5$ mm

REMS Hurrican – for making T-branches yourself. Inexpensive. Also on tubes already installed.

System advantage

Only one type of extractor tools for REMS Hurrican H, REMS Hurrican and REMS Twist/Hurrican. Simple, inexpensive storage. No confusion possible.

Cost advantage

No costs for T-branches, storage, procurement. Savings in soldering joints, soldering material and working hours. Higher safety by fewer tube joints.

Design

Compact, handy, light. Can be used anywhere, free-hand, on pipes already installed. Drill head provides precise drilling without punching with any standard power drill. Drill depth-stop according to the size of T-branch. Tool holder for holding the extractor tools. Limitation of insertion depth to avoid obstruction by using the dimpling pliers. Handy grip wrench for clamping the tool holder onto the pipe.

Drive

Proven drive unit with hexagon mount. Enormously powerful. Handy, light, only 2 kg. Can be used anywhere, free-hand, also on pipes already installed. Robust, maintenance-free gear with safety slipping clutch. Universal motor, 600 W, high-torque forward and reverse at low speed. Stepless, electronic speed control. The speed between 0 and 550 rpm is controlled by pressing the tip switch steplessly (acceleration switch).

Extractor tools

Special design of extractor tools facilitate even and smooth material deformation without burrs and notches. Therefore no secondary treatment required.

REMS Twist/Hurrican

Space and weight-saving combination set for efficient production of T-branches and for efficient cold-expanding of hard and soft tubes for installations without fittings. Only one drive unit for expanding and extracting tools. Price advantage! See page 187.



German Quality Product



Supply format

REMS Hurrican Set. Electric tube extractor for hard and soft copper tube \varnothing 10–22 mm, \varnothing $\frac{3}{8}$ – $\frac{7}{8}$ " , $s \leq .5$ mm. Drive unit with hexagon mount, maintenance-free gear, universal motor 230 V or 110 V, 50–60 Hz, 600 W. High torque at low speed, left and right-hand rotation. Safety tip switch. Stepless, electronic speed control (acceleration switch). Drive holder. Tool holder, drill head, dimpling pliers, lubricant. Extractor tools for pipes in mm or inch. In sturdy steel case.

Description	Art.-No.
Set 12-15-18-22	151000
Set 12-14-16-18-22	151010
Set $\frac{3}{8}$ - $\frac{1}{2}$ - $\frac{5}{8}$ - $\frac{3}{4}$ - $\frac{7}{8}$ "	151002

Other voltages on request.



Accessories

Description	Tubes \varnothing mm/inch	Art.-No.
Extractor tool	10	151105
	12	151110
	14	151120
	15	151125
	16	151130
	18	151140
	20	151145
	22	151150
	$\frac{3}{8}$ "	151155
	$\frac{1}{2}$ "	151160
	$\frac{5}{8}$ "	151165
$\frac{3}{4}$ "	151170	
$\frac{7}{8}$ "	151175	
REMS Twist/Hurrican drive unit with stabiliser		151401
Tool holder		151200
Drill head		151210
Dimpling pliers		151230
Lubricant (tin)		151240
Case with inlay		151618



Powerful, compact electric tool for efficient cold-expanding of hard and soft tubes for pipe installations without fittings.

Hard and soft copper tubes	Ø 12–22 mm
	Ø 3/8–7/8"
	s ≤ 1 mm

REMS Twist – for making sockets yourself. Cold-expanding of hard copper pipes.

Cost advantage

No costs for annealing hard copper tubes, for deburring and cleaning, for fittings, storage, procurement. Savings in soldering joints, soldering material and working hours. Higher safety by fewer tube joints. Using up tube pieces to make sockets.

Design

Compact, robust, job site-proven. Simple and fast working free-hand, at vice or workbench. No adjustments. Integrated clamping device provides safe support against torque in both directions.

Drive

Proven drive unit with hexagon mount. Enormously powerful. Handly, light, only 2 kg. Can be used anywhere, free-hand, also on pipes already installed. Robust, maintenance-free gear with safety slipping clutch. Universal motor, 600 W, high-torque forward and reverse at low speed. Stepless, electronic speed control. The speed between 0 and 550 rpm is controlled by pressing the tip switch steplessly (acceleration switch).

Expander tools

One quick-changing expander tool of each tube size with rotating mandrel for easy expanding and smooth operation. Without annealing, standard socket in just a few seconds, extra long.

REMS Twist/Hurrican

Space and weight-saving combination set for efficient production of T-branches and for efficient cold-expanding of hard and soft tubes for installations without fittings. Only one drive unit for expanding and extracting tools. Price advantage! See page 187.



German Quality Product

Supply format

REMS Twist Set. Electric tube expander for hard and soft copper tubes Ø 12–22 mm, Ø 3/8–7/8", s ≤ 1 mm. Drive unit with hexagon mount, maintenance-free gear, universal motor 230 V or 110 V, 50–60 Hz, 600 W. High torque at low speed, left and right-hand rotation. Safety tip switch. Stepless, electronic speed control (acceleration switch). Drive holder. Lubricant. Expander tools for mm or inch. In sturdy steel case.

Description	Art.-No.
Set 12-15-18-22	156000
Set 12-14-16-18-22	156002
Set 3/8-1/2-5/8-3/4-7/8"	156004

Other voltages on request.

Accessories

Description	Tubes Ø mm/inch	Art.-No.
Expander tool	12	156150
	14	156200
	15	156225
	16	156250
	18	156300
	22	156350
	3/8"	156375
	1/2"	156400
	5/8"	156425
	3/4"	156450
7/8"	156475	
REMS Twist/Hurrican drive unit with stabiliser		151401
Lubricant (tin)		151240
Steel case with insert		151600



REMS Twist/Hurrican

Electric tube extractor
Electric tube expander

Powerful, compact electric tool for efficient machining of T-branches and for efficient cold-expanding of hard and soft tubes for tube installations without fittings.

Extracting:

Hard and soft copper tubes \varnothing 10–22 mm
 \varnothing $\frac{3}{8}$ – $\frac{7}{8}$ "
 $s \leq 1.5$ mm

Expanding:

Hard and soft copper tubes \varnothing 12–22 mm
 \varnothing $\frac{3}{8}$ – $\frac{7}{8}$ "
 $s \leq 1$ mm

REMS Hurrican for making T-branches yourself. Inexpensive. Also on tubes already installed.

REMS Twist for making sockets yourself. Cold-expanding of hard copper tubes.

Space and weight saving combi set. Only **one** drive unit for expander and extractor tools. Price advantage!

Description see REMS Hurrican and REMS Twist (page 185–186).



German Quality Product

Supply format

REMS Twist/Hurrican Combi Set. Electric tube expander and electric tube extractor for hard and soft copper tubes. Expanding \varnothing 12–22 mm, \varnothing $\frac{3}{8}$ – $\frac{7}{8}$ ", $s \leq 1$ mm, extracting \varnothing 10–22 mm, \varnothing $\frac{3}{8}$ – $\frac{7}{8}$ ", $s \leq 1.5$ mm. Drive unit with hexagon mount, maintenance-free gear, universal motor 230 V or 110 V, 50–60 Hz, 600 W. High torque at low speed, left and right-hand rotation. Stepless, electronic safety switch. Drive holder. Tool holder, drill head, dimpling pliers, lubricant. Choice of expander and extractor tools for pipes in mm or inch. In sturdy steel case.

Description	Art.-No.
Set 12-15-18-22	156010
Set 12-14-16-18-22	156012
Set $\frac{3}{8}$ – $\frac{1}{2}$ – $\frac{5}{8}$ – $\frac{3}{4}$ – $\frac{7}{8}$ "	156014

Other voltages on request.



Accessories

Description	Tubes \varnothing mm/inch	Art.-No.
Expander tool	12	156150
	14	156200
	15	156225
	16	156250
	18	156300
	22	156350
	$\frac{3}{8}$ "	156375
	$\frac{1}{2}$ "	156400
	$\frac{5}{8}$ "	156425
	$\frac{3}{4}$ "	156450
	$\frac{7}{8}$ "	156475
Extractor tool	10	151105
	12	151110
	14	151120
	15	151125
	16	151130
	18	151140
	20	151145
	22	151150
	$\frac{3}{8}$ "	151155
	$\frac{1}{2}$ "	151160
	$\frac{5}{8}$ "	151165
$\frac{3}{4}$ "	151170	
$\frac{7}{8}$ "	151175	
REMS Twist/Hurrican drive unit with stabiliser		151401
Tool holder		151200
Drill head		151210
Dimpling pliers		151230
Lubricant (tin)		151240
Steel case with insert		151600



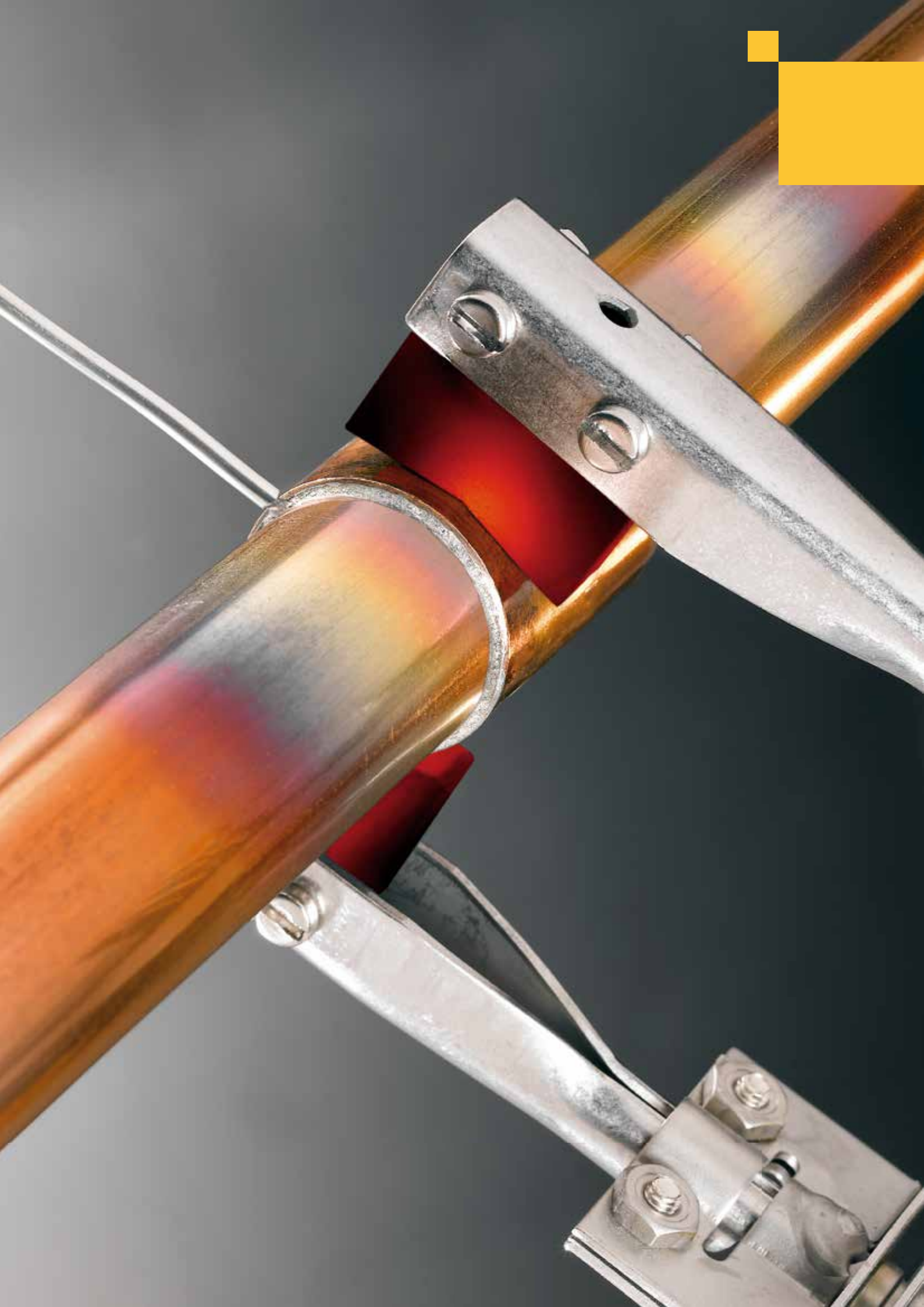

Soldering

	Cleaning pads	190
	Electric soldering pliers	190
	Electric soldering unit	191
	Turbo soldering torches	192
	Solder wire and solder paste	193

REMS Cu-Vlies

Cleaning pads

Metal-free, highly flexible cleaning pads for cleaning surfaces to be soldered on copper tubes and soldering fittings. Also for other materials.

REMS Cu-Vlies – clean surfaces according to DVGW.

Universal use, for many materials, highly flexible. Cleans metallic clear, dirt and oxide-free, according to DVGW work sheet GW 2. Clean finish. Multiple use, reusable by washing out, thus long service life. Can be used wet or dry.

Supply format

REMS Cu-Vlies. Metal-free, highly flexible cleaning pad for cleaning areas to be soldered on copper pipes and soldering fittings. Pack of 10.

	Art.-No.	
	160300	



German Quality Product

REMS Hot Dog 2

Electric soldering pliers

Efficient, light-weight electric tool for soft soldering. Directly connected to a socket, no transformer required. For trade and industry. For the building site and the workshop.

Copper tubes	Ø 10–28 mm Ø 3/8–1 1/8"
Heating capacity	800°C

REMS Hot Dog 2 – the smallest and most powerful soldering pliers. Super fast without flame.

Super fast soldering, e.g. Ø 18 mm in only 15 s. Enormous heating capacity up to 800°C through 2 heating cartridges. For permanent use.

Super light and handy, complete only 0.7 kg. Can be used anywhere, in confined areas also.



German Quality Product

Supply format

REMS Hot Dog 2 Set. Electric soldering pliers for soft soldering copper tubes Ø 10–28 mm, Ø 3/8–1 1/8". 230 V, 50–60 Hz, 440 W. 250 g REMS Lot Cu 3 and REMS Paste Cu 3. Cleaning brush. In steel case with fire retarding insert.

	Art.-No.	
	163020	

Other voltages on request.

Accessories

Description	Art.-No.	
REMS soldering material see page 193.		
Steel case with fire-proof inlay	163350	



REMS Contact 2000

Electric soldering unit

Compact, powerful electric tool for soft soldering. With safety transformer. For trade and industry. For the building site and the workshop.

Copper tubes	Ø 6–54 mm Ø ¼–2 1/8"
Heating capacity	900°C (1650°F)

REMS Contact 2000 – the smallest, strongest and fastest unit of its kind. 2000 W soldering power. 4 m long soldering tongs cable.

Handy, compact. Favourable weight, small in size for work and transport. L×W×H: 210×150×140 mm.

Enormous heating capacity (900°C) ensures super-fast soldering. Rated power = Soldering capacity = 2000 W! Soldering time, e.g. for Ø 18 mm in only 18 s.

Can be used anywhere, with rod electrodes in tight spots also. Ready to solder any time, to be connected to a socket only. No adjustment of soldering current necessary. Wide work radius thanks to 4 m cable length. Flexible cable protector hose.

Indifferent to temperature influences electric control of soldering current.

Prisma-electrodes for universal use, maximum use through favorable seat. Rod-electrodes for working in tight spots. Electrode holders and bolts in stainless steel. Electrodes can be easily replaced.



German Quality Product



Prisma-electrodes for universal use, maximum use through favorable seat.

Supply format

REMS Contact 2000. Electric soldering unit for soft soldering of copper tubes Ø 6–54 mm, Ø ¼–2 1/8". 230 V, 50–60 Hz, 2000 W, control voltage 24 V. Soldering pliers with 4 m cable length. Safety transformer, 2 prism electrodes. In a carton.

	Art.-No.	
	164011	

Other voltages on request.

Supply format

REMS Contact 2000 Super-Pack. Electric soldering unit for soft soldering of copper tubes Ø 6–54 mm, Ø ¼–2 1/8". 230 V or 110 V, 50–60 Hz, 2000 W, control voltage 24 V. Soldering pliers with 4 m cable length, safety transformer, 4 prism electrodes, 2 rod electrodes, 250 g quality soft solder REMS Lot Cu 3, 250 g quality soft solder paste REMS Paste Cu 3, 1 tubing cutter REMS RAS Cu-INOX 3-35, pack of 10 cleaning pads REMS Cu-Vlies. In sturdy steel case.

	Art.-No.	
	164050	



Accessories

Description	Art.-No.
Prism electrodes (pack of 2)	164111
Prism electrodes with holders (pack of 2)	164110
Rod electrodes (pack of 2)	164115
Steel case with insert	164250

REMS soldering material see page 193.



REMS Blitz

Turbo soldering torch propane

Handy self-lighting torch with turbo-flame for fast soft soldering and economic gas consumption.

Copper tubes $\varnothing \leq 35 \text{ mm}$

Heating, annealing, burning, melting, thawing, shrinking and similar thermal procedures.

Flame temperature 1950°C (3500°F)

REMS Blitz – extremely fast soft soldering.

Piezo-electric self-lighting

Without igniter! Pull trigger – flame comes on! Release trigger – flame goes out! Little gas consumption, only 160 g/h!

Design

Super handy, ergonomic, with one hand only. No setting, no adjustment. Locking button for continuous operation. Only 1 universal flame tube. Small gas bottles can be used.

Turbo-flame

Spot-flame with turbo-twisting-booster for high heating capacity and super fast soft soldering.



Supply format

REMS Blitz. Turbo soldering torch propane for soft soldering of copper tubes $\varnothing \leq 35 \text{ mm}$. Piezo-electric self-lighting. Hose connector BSPP $\frac{3}{8}$ " LH. Hollow cap nut and socket BSPP $\frac{3}{8}$ " LH. In blister pack.

	Art.-No.
	160010

Accessories

Description	Art.-No.
REMS soldering material see page 193.	
High pressure hose 3 m , BSPP $\frac{3}{8}$ " LH	152106
Pressure reducer for 5 or 11 kg gas bottles (2 bar)	152109



REMS Macho

Turbo soldering torch acetylene

Handy self-lighting torch with turbo-flame for extremely fast brazing and soft soldering. Economic gas consumption.

Copper tubes and others $\varnothing \leq 64 \text{ mm}$

Heating, annealing, burning, melting, thawing, shrinking and similar thermal procedures.

Flame temperature 2500°C

REMS Macho – super fast brazing.

Piezo-electric self-lighting

Without igniter! Pull trigger – flame comes on! Release trigger – flame goes out! Little gas consumption, only 360 g/h!

Acetylene only

Injection torch burns atmospheric oxygen. Hence only acetylene necessary.

Design

Super handy, ergonomic, with one hand only. No setting, no adjustment. Locking button for continuous operation. Only 1 universal flame tube.

Turbo-flame

Spot-flame with turbo-twisting-booster for extremely high heating capacity and super fast brazing.



Supply format

REMS Macho. Turbo soldering torch acetylene for brazing and soft soldering of copper tubes and others $\varnothing \leq 64 \text{ mm}$. Piezo-electric self-lighting. Hose connector BSPP $\frac{3}{8}$ " LH. Hollow cap nut and socket $\frac{3}{8}$ " LH. In blister pack.

	Art.-No.
	161010

Accessories

REMS soldering material see page 193.

REMS Lot Cu 3

Soft solder S-Sn97Cu3, EN 29453

Soft soldering of copper tubes with copper, red copper cast and brass fittings for cold and hot water installation, heating installation $\leq 110^{\circ}\text{C}$ (230°F).

In accordance with DVGW work sheet GW 2.

Alloy (weight %) 97% Sn, 3% Cu
Melting temperature 230–250°C (450–480°F)

REMS Lot Cu 3 – quality soft solder.

Lead-free, harmless to health and environment.
Silver-free, complies with standards. Very low price.

Supply format

REMS Lot Cu 3. 250-g spool soft solder wire S-Sn97Cu3, EN 29453, \varnothing 3 mm, for soft soldering of copper tubes with copper, red copper cast and brass fittings for cold and hot water installation, heating installation $\leq 110^{\circ}\text{C}$ (230°F).

	Art.-No.
	160200



German Quality Product

REMS Paste Cu 3

Soft solder paste of solder powder S-Sn97Cu3 according to EN 29453 and flux 3.1.1.C, EN 29454-1

Soft soldering of copper tubes with copper, red copper cast and brass fittings for cold and hot water installation, heating installation $\leq 110^{\circ}\text{C}$ (230°F).

In accordance with DVGW work sheet GW 7 (DVGW-Reg.-Nr. DV-0101AP2793)

REMS Paste Cu 3 – quality soft solder paste.

Lead-free, harmless to health and environment.
Silver-free, complies with standards. Very low price.

No additional flux consumption, paste contains flux already.
Thus less danger of corrosion.

No overheating of tube and fitting because the melting of solder and the required temperature for soldering is clearly visible through the change of colour of paste.

High filling level of soldering joint, thereby good stability. Easy cleaning of remnants which are soluble in cold water.

Plastic bottle with brush integrated in cap which cannot get lost.

Supply format

REMS Paste Cu 3. 250-g soft solder paste of solder powder S-Sn97Cu3 according EN 29453 and flux 3.1.1.C, EN 29454-1, for soft soldering of copper tubes with copper, red copper cast and brass fittings for cold and hot water installation, heating installation $\leq 110^{\circ}\text{C}$ (230°F). DVGW approval mark FI 038. In plastic bottle with integrated brush.

	Art.-No.
	160210



German Quality Product

REMS Lot P6

Brazing solder B-Cu94P-710/890, EN 1044

Brazing of copper tubes with copper, red copper cast and brass fittings in cold and hot water installation, gas installation, refrigerating and air conditioning applications.

In accordance with DVGW work sheet GW 2.

Alloy (weight %) 94% Cu, 6% P
Melting temperature 710–890°C (1310–1640°F)

REMS Lot P6 – quality brazing solder.

Universally applicable for almost all types of joints in copper pipe installations. Specially useful for capillary brazing joints of copper pipe installations without fittings. Wide melting range due to low phosphor content result in higher toughness of soldering joint.

Silver-free, complies with standards. Very low price.

Supply format

REMS Lot P6. 1 kg brazing solder (rods) B-Cu94P-710/890, EN 1044, \varnothing 2 mm, for brazing of copper tubes with copper, red copper cast and brass fittings for cold and hot water installation, gas installation, refrigerating and air conditioning applications. In a carton.

	Art.-No.
	160220





Freezing



Pipe freezer CO₂

196



Electric pipe freezing unit

197

REMS Eskimo

Pipe freezer

Simple, fast freezing of unemptied pipes with a carbon dioxide coolant. For repair, extensions of piping systems.

Steel, copper, plastic,
composite pipes

Ø 1/8–2"
Ø 10–60 mm

Refrigerant: carbon dioxide.

Refrigerating capacity to –79°C (–110°F).

Non toxic, non flammable.

**REMS Eskimo – freezing instead of draining.
Super fast. Automatic refrigerant feed. High cooling capacity, e.g. 3/4" steel pipe in only 5 min.
Very small, indestructible freeze collars.**

Refrigerant

Carbon dioxide coolant with high cooling performance up to –79°C. Non toxic. Non flammable. Easy to obtain.

Design

Tight contact between freeze collars and pipe and direct flow of the refrigerant onto the pipe ensure extremely short freezing times and economic refrigerant consumption. Freezing is possible on one or two sides, with additional T-distributors further freeze collars can also be connected.

Freeze collars

Easy. Rapid assembly, without special tools. Very small, highly flexible, indestructible freeze collars in cold-resistant thermoplastic elastomer, for operating even in the tightest spots. Clamping screws cannot get lost.

Handle piece with injector

Ergonomically designed handle pieces in plastic for comfortable operation. Unbreakable brass injector (injection nozzle). Fast and secure connection to freeze collars. No setting, the correct amount of refrigerant is automatically supplied.

High pressure hoses

Flexible, buckling-resistant and fractureproof high pressure hoses. Extra long for wide work radius. Extendable any time. Turnable hollow cap nut at bottle connector prevents high pressure hoses from tangling.



German Quality Product

Supply format

REMS Eskimo Set. Pipe freezing device for carbon dioxide coolant. For steel, cast iron, lead, copper, plastic pipes Ø 1/8–2", Ø 10–60 mm. Two freezing jackets each in 10 different sizes for the whole working range, flange connection with T-junction, locking nut, 2 handles with injector, 2 high-pressure hoses. In sturdy carrying case.

	Art.-No.
	130002



Accessories

Description	Size	Art.-No.	
Freezing jacket	1/8"	10/12 mm	130450
	1/4"	15 mm	130455
	3/8"	18 mm	130460
	1/2"	22 mm	130465
	3/4"	28 mm	130470
	1"	35 mm	130475
	1 1/4"	42 mm	130480
	1 1/2"		130485
		54 mm	130490
		2"	60 mm
High-pressure hose 2 m		130415	
T-distributor for further collar		130207	
Locking nut		130209	
Double nipple		130208	
Handle piece with injector		130410	
Case with inlay		130430	



REMS Frigo 2

Electric pipe freezing unit

Easy, fast freezing of pipes which are not drained.
Closed refrigerant circuit. Environmentally safe.
For repair and extension of piping systems.

Steel, copper, plastic,
composite pipes Ø 1/8–2"
Ø 10–60 mm

Refrigerant: R-404A.

REMS Frigo 2 – electrically freezing instead of draining. Super fast up to 2". High cooling capacity, e.g. 3/4" steel pipe in only 9 min*. Particularly compact, patented deep-freezer heads, for very fast assembly. Temperature display with LCD digital thermometer.

System advantage

Only one pipe freezing unit for the complete working range up to 2". One-size freezer heads for the core working range Ø 1/4–1" / Ø 15–35 mm, no reducing inserts required. Aid the cooling process simply by spraying with water. Always clean freezer heads, no pastes/greases required.

Closed refrigerant circuit

Electric pipe freezing unit with closed refrigerant circuit. Environmentally safe. Can be used anywhere, also in closed rooms. Refrigerant R-404A. High cooling capacity. Ideal also for longer repairs.

Design

Robust, compact. Very small deep-freezer heads fitted parallel to the pipe leaving refrigerant hoses for working in confined areas and niches also. Single or double freezing possible.

Cooling aggregate

Very quiet. Cooling aggregate, 430 W, in sturdy sheet metal housing with ventilating side openings for optimum air circulation. Large top compartment, easily accessible, for refrigerant hoses and accessories. Weighs only 23 kg. Easy to carry.

Deep-freezer heads

Very compact deep-freezer heads with special geometrically shaped cavities for seating different pipe diameters (**Patent EP 1 108 944, Patent US 6,434,952**). Very small, only 50 mm wide. All pipe sizes from Ø 1/4–1" resp. Ø 15–35 mm can be frozen with only one deep-freezer head. Deep-freezer inserts for the rest of the capacity up to 2", 60 mm. Tightening straps for simple and quick assembly of deep-freezer heads onto the pipe, without tools.

Refrigerant hoses

Flexible, extra-long refrigerant hoses in wear resistant, synthetic rubber for large work radius.

LCD-Digital-Thermometer

LCD digital thermometer with clip, for exact temperature display directly at the freezing points.



German Quality Product

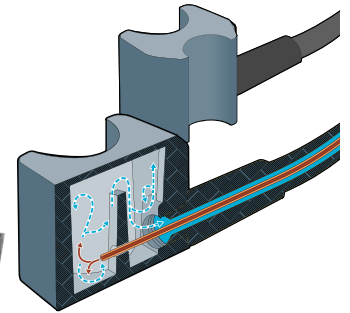

Super fast up to 2"



Supply format

REMS Frigo 2 Set. Electric pipe freezing unit with closed refrigerant circuit. For steel, copper, plastic, composite pipes, Ø 1/8–2", Ø 10–60 mm. Cooling aggregate 230 V or 110 V, 50 Hz, 430 W, 2 refrigerant hoses, 2 LCD digital thermometers, 2 tightening straps, squirt bottle. Equipped for Ø 1/4–1", 15–42 mm. In sturdy sheet metal housing.

	Art.-No.
	131011

Accessories

Description	Size	Art.-No.
Extension kit up to 2", 60 mm	1 1/2–2" / 54–60 mm	131160
Deep-freeze inserts (pack of 2)	1/8" 10, 12 mm	131110
	1 1/2" 54 mm	131157
	2" 60 mm	131158



*ambient/water temperature approx. 18°C.



REMS CamSys

Pipe and Drain inspection

Pipe and Drain cleaning

	Endoscope cameras	200
	Electronic camera inspection systems	204
	Drain cleaner for manual and electric operation	206
	Electric drain cleaning machine	207
	Electric pipe and drain cleaning machines	208

REMS CamScope Wi-Fi

Endoscope camera with Wi-Fi radio standard

Mobile, handy endoscope camera with Wi-Fi radio standard for low cost inspection and damage analysis of places with difficult access such as cavities, shafts, pipes etc. Wireless transmission of photos and videos to Smartphones/tablet PCs with Android and iOS operating systems.

Camera head Ø 4.5/9/16 mm

REMS CamScope Wi-Fi – Brilliant pictures and videos of cavities, shafts and pipes.

Wireless transmission of photos and videos to Smartphones/tablet PCs with Android and iOS operating systems.

Design

Ultra light and handy. Hand-held unit with camera cable set only 0.3 to 0.5 kg. Can be used everywhere, free hand, over head, also in very confined spaces. Sturdy, impact-proof plastic housing with ergonomically shaped handle. On/off thumbwheel switch for continuous brightness control of the LEDs in the camera head. Power LED for indicating the operating state. Practical, removable battery holder for 4 commercially available 1.5 V, AA, LR6 batteries. Various camera cable sets can be used. Plug-screw connections for changing the camera cable sets and the push cable extensions without tools. Sturdy case for hand-held unit, camera cable set 16-1/9-1/4.5-1, push cable extension, controller unit, voltage supply/charger and accessories.

Controller unit

Controller unit with Wi-Fi radio standard for wireless transmission of photos and videos to Smartphones/tablet PCs with Android and iOS operating systems. REMS application software for Android or iOS operating systems required.

Application software

REMS CamScope App application software for real time monitoring of the inspection results on the high resolution display of a Smartphone/Tablet-PC. Voice recording for simple commentary during the video recording. Immediate playback of saved recordings or transmission to other devices via e-mail for easy documentation. Free REMS application software from the Apple App Store or Android App at Google Play.

Exchangeable camera cable set Color

Camera cable set Color, consisting of colour camera Ø 4,5 mm, Ø 9 mm or Ø 16 mm, with CMOS sensor with dimmable white light LEDs for optimum setting of the brightness and fixed focus function for automatic picture focus, protected against occasional immersion in water (IP 67). Camera cable set Color 16-1 and 9-1 with 1 m flexible push cable and add-on mirror, add-on hook, add-on magnet. Camera cable set Color 4.5-1 with 1 m flexible push cable, ideal for inspecting small pipe bends and narrow places, e.g. odour traps, bore holes, breakthroughs. Flexible 900 mm push cable extension, connectable up to a working length of 4.5 m, as an accessory. Camera cable set Color 16-1 90°, with right-angled colour camera Ø 16 mm, 640 × 480 pixels, with 1 m flexible push cable, as an accessory.



REMS CamScope Wi-Fi

Endoscope camera with Wi-Fi radio standard

Supply format

REMS CamScope Wi-Fi Set. Mobile, handy endoscope camera with Wi-Fi radio standard for low cost inspection and damage analysis of places with difficult access such as cavities, shafts, pipes etc. Wireless transmission of photos and videos with voice recording to Smartphones/tablet PCs with Android or iOS* operating systems. Controller unit with 4 batteries 1.5 V, AA, LR6. In sturdy case. Optional with camera cable set 4.5-1, camera cable set 9-1 or camera cable set 16-1.

Description	Version	Art.-No.	
Set 16-1	Camera cable set Color 16-1, consisting of colour camera Ø 16 mm, 704 × 576 pixels, with dimmable white light LEDs and fixed focus function and 1 m formable push cable. Add-on mirror, add-on hook, add-on magnet	175140	
Set 9-1	Camera cable set Color 9-1, consisting of colour camera Ø 9 mm, 640 × 480 pixels, with dimmable white light LEDs and fixed focus function and 1 m formable push cable. Add-on mirror, add-on hook, add-on magnet	175141	
Set 4,5-1	Camera cable set Color 4.5-1, consisting of colour camera Ø 4.5 mm, 320 × 240 pixels, with dimmable white light LEDs and fixed focus function and 1 m formable push cable. Ideal for inspecting small pipe bends and narrow places.	175142	

*REMS CamScope App required. Free from the Apple App Store or Android App at Google Play.



Accessories

Description	Art.-No.	
Camera cable set Color 16-1 , colour camera Ø 16 mm, 704 × 576 pixels, with 1 m flexible push cable. Add-on mirror, add-on hook, add-on magnet	175103	
Camera cable set Color 16-1 90° , right-angled colour camera Ø 16 mm, 640 × 480 pixels, with 1 m flexible push cable.	175106	
Camera cable set Color 9-1 , colour camera Ø 9 mm, 640 × 480 pixels, with 1 m flexible push cable. Add-on mirror, add-on hook, add-on magnet	175104	
Camera cable set Color 4.5-1 , colour camera Ø 4.5 mm, 320 × 240 pixels, with 1 m flexible push cable.	175102	
900 mm push cable extension , flexible, connectable up to a working length of 4.5 m	175105	



Mobile, handy endoscope camera with radio signal transmission for low cost inspection and damage analysis of places with difficult access such as cavities, shafts, pipes etc. Documentation of photos and videos on MicroSD card. REMS CamScope S with voice recording. For battery and mains operation.

Camera head Ø 4.5/9/16 mm

REMS CamScope – Brilliant pictures and videos of cavities, shafts and pipes. Removable controller unit. Radio signal transmission MicroSD card slot.

REMS CamScope S – with voice recording.

Design

Ultra light and handy. Hand-held unit with camera cable set only 0.3 to 0.5 kg. Can be used everywhere, free hand, over head, also in very confined spaces. Sturdy, impact-proof plastic housing with ergonomically shaped handle. On/off thumbwheel switch for continuous brightness control of the LEDs in the camera head. Power LED for indicating the operating state. Practical, removable battery holder for 4 commercially available 1.5 V, AA, LR6 batteries. Various camera cable sets can be used. Plug-screw connections for changing the camera cable sets and the push cable extensions without tools. Sturdy case for hand-held unit, camera cable set 16-1/9-1/4.5-1, push cable extension, controller unit, voltage supply/charger and accessories.

Controller unit with TFT-LCD colour display

Controller unit with 3.5" colour display with state of the art TFT-LCD technology for brilliant pictures and videos, 88 mm screen diagonal, 320 x 240 pixels, removable for radio signal transmission or securely pluggable to hand-held unit for direct signal transmission by contact pins. Very light and handy: REMS CamScope only 0.14 kg, REMS CamScope S only 0.24 kg. Sturdy plastic housing, spray water protected, REMS CamScope S with rubber impact protection. Small dimensions: REMS CamScope 102 x 71 x 25 mm, REMS CamScope S 105 x 92 x 42 mm. MicroSD card slot with spring release mechanism. Photos and videos can be saved on a MicroSD card for simple documentation of the inspection result. REMS CamScope S with voice recording for easy commentary during video recording. REMS CamScope S with 3x digital zoom. The date and time of the recording can be saved in the photo and video as an option. Immediate playback of saved recordings or transmission to other devices via MicroSD card. Playing of the voice recording in REMS CamScope S by external devices, e.g. PC or laptop. USB connector for direct connection to PC or laptop. Video output socket Composite-Video PAL/NTSC for connecting an external monitor. Connection for voltage supply/charger Li-Ion 100–240 V.

Cordless and mains operation

Li-Ion technology. Controller unit with integrated Li-Ion 3.7 V, 1.2 Ah battery. Powerful and light. High energy density for approx. 2 hours continuous operation. Voltage supply 100–240 V, 50–60 Hz, 9 W, for mains operation instead of battery with integrated electronic Li-Ion charger. No memory effect for maximum battery performance.

Exchangeable camera cable set Color

Camera cable set Color, consisting of colour camera Ø 4,5 mm, Ø 9 mm or Ø 16 mm, with CMOS sensor with dimmable white light LEDs for optimum setting of the brightness and fixed focus function for automatic picture focus, protected against occasional immersion in water (IP 67). Camera cable set Color 16-1 and 9-1 with 1 m flexible push cable and add-on mirror, add-on hook, add-on magnet. Camera cable set Color 4.5-1 with 1 m flexible push cable, ideal for inspecting small pipe bends and narrow places, e.g. odour traps, bore holes, breakthroughs. Flexible 900 mm push cable extension, connectable up to a working length of 4.5 m, as an accessory. Camera cable set Color 16-1 90°, with right-angled colour camera Ø 16 mm, 640 x 480 pixels, with 1 m flexible push cable, as an accessory.



Supply format

REMS CamScope Li-Ion Set. Mobile, handy endoscope camera with radio signal transmission for low cost inspection and damage analysis of places with difficult access such as cavities, shafts, pipes etc. Documentation of photos and videos on MicroSD card. Handheld unit with 4 batteries 1.5 V, AA, LR6 Removable controller unit with radio signal transmission, 3.5" TFT-LCD colour display, MicroSD card slot, USB port, video out socket PAL/NTSC, integrated Li-ion battery, 3.7 V, 1.2 Ah. 2 GB MicroSD card Voltage supply/charger Li-Ion 100–240 V, 50–60 Hz, 9 W, for controller unit. USB cable, video cable. In sturdy case. Optional with camera cable set 4.5-1, camera cable set 9-1 or camera cable set 16-1.

Description	Version	Art.-No.
Set 16-1	Camera cable set Color 16-1, consisting of colour camera Ø 16 mm, 704 × 576 pixels, with dimmable white light LEDs and fixed focus function and 1 m formable push cable. Add-on mirror, add-on hook, add-on magnet	175110
Set 9-1	Camera cable set Color 9-1, consisting of colour camera Ø 9 mm, 640 × 480 pixels, with dimmable white light LEDs and fixed focus function and 1 m formable push cable. Add-on mirror, add-on hook, add-on magnet	175111
Set 4,5-1	Camera cable set Color 4.5-1, consisting of colour camera Ø 4.5 mm, 320 × 240 pixels, with dimmable white light LEDs and fixed focus function and 1 m formable push cable. Ideal for inspecting small pipe bends and narrow places.	175112



Supply format

REMS CamScope S Li-Ion Set. Mobile, handy endoscope camera with radio signal transmission for low cost inspection and damage analysis of places with difficult access such as cavities, shafts, pipes etc. Documentation of photos and videos with voice recording on MicroSD card. Handheld unit with 4 batteries 1.5 V, AA, LR6 Removable controller unit with radio signal transmission, 3.5" TFT-LCD colour display, 3x digital zoom, MicroSD card slot, USB port, video out socket PAL/NTSC, integrated Li-ion battery, 3.7 V, 1.2 Ah. 2 GB MicroSD card Voltage supply/charger Li-Ion 100–240 V, 50–60Hz, 9 W, for controller unit. USB cable, video cable. In sturdy case. Optional with camera cable set 4.5-1, camera cable set 9-1 or camera cable set 16-1.

Description	Version	Art.-No.
Set 16-1	Camera cable set Color 16-1, consisting of colour camera Ø 16 mm, 704 × 576 pixels, with dimmable white light LEDs and fixed focus function and 1 m formable push cable. Add-on mirror, add-on hook, add-on magnet	175130
Set 9-1	Camera cable set Color 9-1, consisting of colour camera Ø 9 mm, 640 × 480 pixels, with dimmable white light LEDs and fixed focus function and 1 m formable push cable. Add-on mirror, add-on hook, add-on magnet	175131
Set 4,5-1	Camera cable set Color 4.5-1, consisting of colour camera Ø 4.5 mm, 320 × 240 pixels, with dimmable white light LEDs and fixed focus function and 1 m formable push cable. Ideal for inspecting small pipe bends and narrow places.	175132



Accessories

Description	Art.-No.
Camera cable set Color 16-1 , colour camera Ø 16 mm, 704 × 576 pixels, with 1 m flexible push cable. Add-on mirror, add-on hook, add-on magnet	175103
Camera cable set Color 16-1 90° , right-angled colour camera Ø 16 mm, 640 × 480 pixels, with 1 m flexible push cable.	175106
Camera cable set Color 9-1 , colour camera Ø 9 mm, 640 × 480 pixels, with 1 m flexible push cable. Add-on mirror, add-on hook, add-on magnet	175104
Camera cable set Color 4.5-1 , colour camera Ø 4.5 mm, 320 × 240 pixels, with 1 m flexible push cable.	175102
900 mm push cable extension , flexible, connectable up to a working length of 4.5 m	175105



Ultra light, handy camera inspection system for inexpensive inspection and damage analysis of pipes, drains, chimneys and other hollow cavities. With electronic metering. Also for inspection after pipe cleaning work and for acceptance of new installations or repairs. Documentation of pictures and videos on SD card. For battery and mains operation.

Camera head	Ø 25 mm
Pipe	Ø (40) 50–150 mm
Drains, chimneys, other cavities	

REMS CamSys Li-Ion – Brilliant pictures and videos of pipes and drains. SD card slot. With electronic metering. For battery and mains operation.

System advantage

Only **one** controller unit with TFT-LCD colour display for connecting different camera cable sets for different requirements. Therefore inexpensive conversion possible.

Design

Ultra light and handy. Can be used everywhere, even in very narrow places. Controller unit connected to the camera cable set by a 2 m connecting cable, removable for easy cleaning of the camera cable set. Various camera cable sets can be used. Plug-screw connections for changing the camera cable sets and the controller unit without tools. Sturdy case for controller unit, voltage supply/charger and accessories.

Controller unit with TFT-LCD colour display

Controller unit with 3.5" colour display with state of the art TFT-LCD technology for brilliant pictures and videos, 89 mm screen diagonal, 320×240 pixels. Very light and handy, only 0.4 kg. Sturdy, impact-proof plastic housing, spray protected. Small dimensions: 172×121×58 mm. Keys for setting the brightness of the LEDs of the colour camera head. Full screen, 2x zoom and reflection possibility. SD card slot with spring release mechanism. Pictures and videos can be saved on an SD card for simple documentation of the inspection result. The date and time of the recording as well as the insertion depth of the camera can be saved in the picture and video as an option. Pictures can be taken during video recording without impairing the video recording. Immediate playback of saved recordings or transmission to other devices via SD card. Pictures can also be taken later from the video during playback of recorded videos on the controller's colour display. USB connector for direct connection to PC or laptop. Video output socket Composite-Video PAL/NTSC for connecting an external monitor. Connection for voltage supply/charger Li-Ion 100–240 V.

Cordless and mains operation

Li-Ion technology. Controller unit with integrated Li-Ion 3.7 V, 2.5 Ah battery. Powerful and light. High energy density for approx. 2 hours continuous operation. Power supply/charger 100–240 V, 50–60 Hz, 10 W, with USB port and USB cable for connecting power supply/charger, laptop or other voltage supply. No memory effect for maximum battery performance.

High resolution special colour camera

High resolution special colour camera Ø 25 mm with CMOS image sensor and 8 ultra bright, white LEDs with adjustable light intensity up to 1700 mcd and concentrated radiation angle for brilliant colour pictures with even illumination. Low light requirement due to very high light sensitivity (0.1 lux). Fixed focus and special lens with 90° wide angle, also for detecting the smallest details.

Exchangeable cable camera sets

Camera cable sets S-Color, consisting of special colour camera with optional 30 m push cable Ø 5.4 mm, flexible, for Ø 50–150 mm, in hasp with electronic metre counter, 20 m push cable Ø 4.5 mm, very flexible, for small pipe diameters and narrower bends Ø (40) 50–150 mm, in the hasp with electronic metre counter or 10 m push cable Ø 4.5 mm with length mark, very flexible, for small pipe diameters and narrower pipe bends Ø (40) 50–150 mm, in the cable reel, with connection for controller unit. Very small, rounded camera head Ø 25 mm, water-tight up to 20 m (0,2 MPa/2 bar/29 psi) and highly flexible sliding spring tapered towards the push cable for effortless feeding even through several pipe bends. Camera head with strong, quick-change protective cap made from high-strength polyacrylic with inserted mineral glass pane. Bend-maneuvring push cable in hybrid technology, with glass fibre core, data cables and plastic sheath, very stable, for long life. Robust, powder-coated, easy to clean cable cage. Hasp with rotary cage for simple unwinding and winding of the push cable and integrated sensor for electronic metering.

Guide bodies

Various guide bodies for larger pipe diameters, firmly lockable on the camera head, as an accessory.



Supply format

REMS CamSys Li-Ion Set S-Color. Electronic camera inspection system for low-cost inspection and damage analysis. Documentation of pictures and videos on SD card with specification of date and time. Controller unit in microprocessor technology with 3.5" TFT-LCD colour display, SD card slot, USB port, video out socket PAL/NTSC, integrated Li-ion battery, 3.7 V, 2.5 Ah, in sturdy, impact-proof plastic housing, spray protected. 2 m connecting cable from the controller unit to the camera cable set, voltage supply/charger 100–240 V, 50–60 Hz, 10 W, SD card 4 GB, USB cable, video cable, in sturdy case. Camera cable set S-Color with high resolution special colour camera Ø 25 mm with CMOS image sensor and push cable.

Description	Version	Art.-No.
Set S-Color 10 K	10 m push cable Ø 4.5 mm with length mark, very flexible, in cable reel. For small pipe diameters and narrower pipe bends Ø (40) 50–150 mm, drains, shafts, stacks and other cavities.	175008
Set S-Color 20 H	20 m push cable Ø 4.5 mm, very flexible, in the hasp with electronic metre counter. For small pipe diameters and narrower pipe bends Ø (40) 50–150 mm, drains, shafts, stacks and other cavities.	175007
Set S-Color 30 H	30 m push cable Ø 5.4 mm, flexible, in the hasp with electronic metre counter. For pipes Ø 50–150 mm, drains, shafts, stacks and other cavities.	175010



Accessories

Description	Art.-No.
REMS CamSys Li-Ion Basic-Pack Controller unit in microprocessor technology with 3.5" TFT-LCD colour display, SD card slot, USB port, video out socket PAL/NTSC, integrated Li-ion battery, 3.7 V, 2.5 Ah, in sturdy, impact-proof plastic housing, spray protected. 2 m connecting cable from the controller unit to the camera cable set, voltage supply/charger 100–240 V, 50–60 Hz, 10 W, SD card 4 GB, USB cable, video cable, in sturdy case.	175000
Camera cable set S-Color 10 K with high resolution special colour camera Ø 25 mm with CMOS image sensor, 10 m push cable Ø 4.5 mm with length marking, very flexible, with connection for controller unit, in cable reel. For small diameters and narrower pipe bends Ø (40) 50–150 mm.	175016
Camera cable set S-Color 20 H with high resolution special colour camera Ø 25 mm with CMOS image sensor and 20 m push cable Ø 4.5 mm, flexible, in the hasp with electronic metering and connection for controller unit. For small diameters and narrower pipe bends Ø (40) 50–150 mm.	175012
Camera cable set S-Color 30 H with high resolution special colour camera Ø 25 mm with CMOS image sensor and 30 m push cable Ø 5.4 mm, flexible, in the hasp with electronic metering and connection for controller unit. For Ø 50–150 mm.	175011
Guide body Ø 62 mm	175057
Guide body Ø 100 mm	175058
Protective cap with mineral glass pane, sealing ring	175026
Case with inlay	175018



REMS Pull-Push

Suction and pressure cleaning device

Proven, reliable suction and pressure cleaning device for fast clearance of blockages.

REMS Pull-Push – fast clearance of blockages.

High pressing force by front, adjustable handle.

Optimum adaptation to the cleaning task by 2 sleeves:

Short sleeve for wash basins and baths, long sleeve for toilets.



Supply format

REMS Pull-Push. Suction and pressure cleaning device for fast clearance of blockages. With short and long sleeve. In a box.

	Art.-No.	
	170300	

REMS Mini-Cobra

Drain cleaner for manual and electric operation

Proven hand unit for quick application to remove pipe blockages in kitchen, bath, toilet.

For pipes \varnothing 20–50 (75) mm
For cables \varnothing 6, 8, 10 mm

REMS Mini-Cobra – by hand or electric. Indispensable to remove small blockages.

Design

Simple, robust, practical design. Handy, light. Only 2.9 kg. Easy operation also in traps and tight bends. Easy insertion of cable directly through strainers in sinks and drains. Locking of cable by quick-action chuck.

Drain cleaning cables

Cables in high quality spring steel. Specially hardened. Highly flexible for effortless feed-forward in tight pipe bends. Cable end with bulbous head (sink strainer head), thus easy to bend.

Cable drum

In hot-galvanized spring steel. Specially hardened. Highly flexible for effortless feed-forward in tight pipe bends. Cable end with bulbous head. Corrosion-resistant cable drum in shock-proof, glass-fibre reinforced plastic prevents pollution of the environment. Ventilation of the cable drum interior enables self-drying of cable. View to cable at all times.

Drive

By hand with easy action, easy grip crank handle or with suitable electric drill/with suitable electric screwdriver, speed \leq 300 rpm. Hexagon adapter for electric drive located in the drum cover.



German Quality Product

Supply format

REMS Mini-Cobra. Pipe cleaning device for pipes \varnothing 20–50 (75) mm, with crank handle and hexagonal driver for electric drill/screwdriver. For drain cleaning cables \varnothing 6, 8 and 10 mm. Cable drum in shock-proof, glass-fibre reinforced plastic. Quick-action chuck. Cable \varnothing 8 mm \times 7.5 m long. In a carton.

	Art.-No.	
	170010	

Accessories

Description	\varnothing \times Length	Art.-No.
Drain cleaning cable	8 mm \times 7.5 m	170200
	10 mm \times 10 m	170205
Drain cleaning cable with core	8 mm \times 7.5 m	170201



REMS Mini-Cobra S

Electric drain cleaning machine

Electric pipe cleaning device with fast switchover. For effortless and quick application to remove pipe blockages in kitchen, bath, toilet.

For pipes \varnothing 20–50 (75) mm
For cables \varnothing 8, 10 mm

REMS Mini-Cobra S – Fast clearance of pipe blockages. Ultra fast reversal of direction of spiral feed/return by fast switchover.

Design

Compact unit of drive machine and cable drum. Handy, light. Only 5.7 kg. Combined thrust and grip handle for controlling the automatic feed-forward and reverse and for safe holding of the unit. Easy operation also in traps and tight bends.

Fast switchover

For easy operation and fast clearance of pipe blockages. Ultra fast reversal of direction of spiral feed/return by fast switchover also under full load without changing the motor's direction of rotation, avoids looping of the spirals when suddenly encountering resistance from pipe blockages, for long life of the spirals.

Drain cleaning cables

Drain cleaning cables in high quality spring steel. Specially hardened. Highly flexible for effortless feed-forward in tight pipe bends. Cable end with bulbous head (sink strainer head), thus easy to bend. Drain cleaning cables with core in high quality spring steel prevents ingress of dirt and generation of long fibres in the cable windings.

Cable drum

Corrosion resistant cable drum in shock-proof, glass-fibre reinforced plastic prevents pollution of the environment. Ventilation of the cable drum interior enables self-drying of cable. View of the cable at any time.

Drive

Proven drive unit with hexagon mount. Enormously powerful. Robust, maintenance-free gear with safety slipping clutch. Universal motor, 600 W, high-torque forward and reverse at low speed. Stepless, electronic speed control. The speed between 0 and 550 rpm is controlled by pressing the tip switch steplessly (acceleration switch).



German Quality Product



Supply format

REMS Mini-Cobra S. Electric pipe cleaning device with fast switchover, for pipes \varnothing 20–50 (75) mm. For drain cleaning cables \varnothing 8 and 10 mm. Drive unit with maintenance-free gear, universal motor 230 V or 110 V, 50–60 Hz, 600 W, high-torque forward and reverse at low speed. Safety tip switch. Stepless, electronic speed control (acceleration switch). Cable drum in shock-proof, glass-fibre reinforced plastic. Cable \varnothing 8 mm, with core, 7.5 m long. In a carton.

	Art.-No.
	170022



Accessories

Description	\varnothing × Length	Art.-No.
Drain cleaning cable with core	8 mm × 7.5 m	170201
Drain cleaning cable	10 mm × 10 m	170205
Steel case		185058



REMS Cobra 22/32

Electric pipe and drain cleaning machines

Handy, robust, compact machines for versatile use in pipe and drain cleaning. High-speed rotator with connectable cable sections. Proven technology.

For pipes \varnothing 20–250 mm
For pipe and drain cleaning cables \varnothing 8, 16, 22, 32 mm

All pipe and drain cleaning cables and tools can also be used for other makes.

REMS Cobra – clear pipe – easy and fast.
High-speed rotator with cable sections for work length up to 100 m. Effective chain knocking and milling up to 740 rpm. Closed drive spindle protects motor and drive against dirt and water.

High speed rotator with connectable cable sections
High-speed rotator, 740 rpm (REMS Cobra 22) resp. 520 rpm (REMS Cobra 32), with cable sections for effective fast operation, e.g. during chain knocking or milling. Under difficult conditions also, e.g. roots and hard incrustations. Cable sections to be connected as needed up to 70 m (REMS Cobra 22) resp. 100 m (REMS Cobra 32) work length. No unnecessary rotating of long pipe and drain cleaning cables.

Design

Robust, practical, splash-proof. Maintenance-free. Small in size. Favourable weight, drive unit REMS Cobra 22 only 19 kg, drive unit REMS Cobra 32 only 24 kg. Machine frame made of distortion-free cast aluminium with protective covers in shock-proof plastic material. Chucking system which is located outside the machine housing with straight through undivided drive spindle for the pipe and drain cleaning cable. This enables a complete seal of the machine interior against dirt and water. Connecting cable with integrated personal protection switch (PRCD). Guide hose prevents excess rotation of pipe and drain cleaning cables and pollution of the environment. Legs with rubber caps guarantee a safe, floor-protecting stand.

High-performance pipe and drain cleaning cables

Specially hardened. Highly flexible for effortless feed-forward in tight pipe bends. Rapid action coupling for fast extension and shortening. T-groove coupling with safety lock through spring-loaded thrust pin. Manual feed-forward for sensitive operation. Standard pipe and drain cleaning cable for universal pipe and drain cleaning jobs, highly flexible, specially suited for tight or several consecutive pipe bends. Pipe and drain cleaning cable S with thicker special spring steel for very difficult to remove obstructions, e.g. root cutting. Drain cleaning cables with weather-proof and temperature resistant plastic core prevents drain cleaning cable from dirt and generation of long fibres in the cable windings. Drive through REMS Cobra 22, REMS Cobra 32 or drive machines of other makes.

Clamping jaws for cable drive

Clamping jaws in high-grade hardened steel, resistant to wear and precise fit. Instant and exact clamping and opening of pipe and drain cleaning cables allow optimum control, power transmission and operating safety. REMS Cobra 22: Choice of pipe and drain cleaning cables \varnothing 16 mm and 22 mm, without changing the clamping jaws. Pipe and drain cleaning cable \varnothing 8 mm with adapter drum 22/8 and integrated clamping jaws, as accessory. REMS Cobra 32: Choice of drain cleaning cables \varnothing 22 and 32 mm, without changing the clamping jaws. Drain cleaning cables \varnothing 16 mm with clamping jaws 16, as accessory. Pipe and drain cleaning cable \varnothing 8 mm with adapter drum 32/8 and integrated clamping jaws, as accessory.

Drive

Powerful, quiet running capacitor motor with high torque, 750 W (REMS Cobra 22), 1050 W (REMS Cobra 32), right and left-hand rotation. Full transmission of motor power by a slipping-proof maintenance-free toothed belt drive. Straight through closed drive spindle. Permanently lubricated, maintenance-free roller bearings. Fast and secure run and stop of pipe and drain cleaning cable through strong, centrally located pressing lever provides central power input. Lever doubles as a carrying device without awkward locking.

Pipe and drain cleaning tools

Large variety of pipe and drain cleaning tools (page 210–211), also fit into pipe and drain cleaning machines of other makes.



German Quality Product

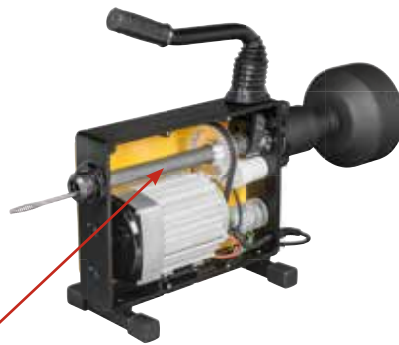

Straight through closed drive spindle protects motor and drive against dirt and water.

Supply format

REMS Cobra 22 Set. Electric pipe and drain cleaning machine for pipes Ø 20–150 mm. Drive unit with maintenance-free belt drive, capacitor motor 230 V, 50 Hz, 750 W, right and left-hand rotation, guide hose. Personal protection switch (PRCD). Choice of cable and tool set 16 or/and 22. In a carton.

Description	Ausführung	Art.-No.
Set 16	5 cable sections 16 × 2.3 m in cable carrier, straight auger 16, bulbous auger 16, toothed blade borer 16/25, cable joint separator, 1 pair of guide gloves, steel case for tool set	172010
Set 22	5 cable sections 22 × 4.5 m in cable carrier, straight auger 22, retrieving auger 22, funnel auger 22, toothed cross-blade borer 22/35, cable joint separator 22/32, 1 pair of guide gloves, steel case for tool set	172011
Set 16 + 22	5 cable sections 16 × 2.3 m in cable carrier, straight auger 16, bulbous auger 16, toothed blade borer 16/25, cable joint separator, 5 cable sections 22 × 4.5 m in cable carrier, straight auger 22, retrieving auger 22, funnel auger 22, toothed cross-blade borer 22/35, cable joint separator 22/32, 2 pairs of guide gloves, steel case for each tool set	172012



Supply format

REMS Cobra 32 Set. Electric pipe and drain cleaning machine for pipes Ø 20–250 mm (½–10"). Drive unit with maintenance-free belt drive, capacitor motor 230 V, 50 Hz, 1050 W, right and left-hand rotation, guide hose. Personal protection switch (PRCD). Choice of cable and tool set 32 or cable and tool sets 22 and 32 or 16 and 22. In a carton.

Description	Ausführung	Art.-No.
Set 32	4 cable sections 32 × 4.5 m in cable carrier, straight auger 32, retrieving auger 32, funnel auger 32, toothed cross-blade borer 32/45, cable joint separator 22/32, 1 pair of guide gloves, case for tool set	174010
Set 22 + 32	5 cable sections 22 × 4.5 m in cable carrier, straight auger 22, retrieving auger 22, funnel auger 22, toothed cross-blade borer 22/35, cable joint separator 22/32, 4 cable sections 32 × 4.5 m in cable carrier, straight auger 32, retrieving auger 32, funnel auger 32, toothed cross-blade borer 32/45, cable joint separator 22/32, 2 pairs of guide gloves, steel case/ case for each tool set	174011
Set 16 + 22	5 cable sections 16 × 2.3 m in cable carrier, 2 clamping jaws 16, straight auger 16, bulbous auger 16, toothed blade borer 16/25, cable joint separator 16, 5 cable sections 22 × 4.5 m in cable carrier, straight auger 22, retrieving auger 22, funnel auger 22, toothed cross-blade borer 22/35, cable joint separator 22/32, 2 pairs of guide gloves, steel case for each tool set	174012



Accessories

Description	Art.-No.
REMS Cobra 22 drive unit with guide hose	172000
REMS Cobra 32 drive unit with guide hose	174000

Pipe and drain cleaning tools see page 210–211.



Description	Size	Art.-No.
Cable and tool set 16 consisting of 5 cable sections 16 × 2.3 m in cable carrier, straight auger 16, bulbous auger 16, toothed blade borer 16/25, cable joint separator, 1 pair of guide gloves, steel case for tool set		172050
Cable and tool set 22 consisting of 5 cable sections 22 × 4.5 m in cable carrier, straight auger 22, retrieving auger 22, funnel auger 22, toothed cross-blade borer 22/35, cable joint separator, 1 pair of guide gloves, steel case for tool set		172051
Cable and tool set 32 consisting of 4 cable sections 32 × 4.5 m in cable carrier, straight auger 32, retrieving auger 32, funnel auger 32, toothed cross-blade borer 32/45, cable joint separator 22/32, 1 pair of guide gloves, case for tool set		174050
Adapter drum REMS Cobra 22/8 with cable Ø 8 mm × 7.5 m long, with bulbous head		170011
Adapter drum REMS Cobra 32/8 with cable Ø 8 mm × 7.5 m long, with bulbous head		170012
Clamping jaws 16 (pack of 2) for REMS Cobra 32 for clamping drain cleaning cables Ø 16 mm		174101
Pipe and drain cleaning cable for pipe-Ø 10–50 (75) mm	8 × 7.5 m	170200
for pipe-Ø 25–125 mm	16 × 2.3 m	171200
for pipe-Ø 50–150 mm	22 × 4.5 m	172200
for pipe-Ø 50–250 mm	32 × 4.5 m	174200
Pipe and drain cleaning cable (5 pieces) in cable carrier for pipe-Ø 25–125 mm	16 × 2.3 m	171201
Pipe and drain cleaning cable (5 pieces) in cable carrier for pipe-Ø 50–150 mm	22 × 4.5 m	172201
Pipe and drain cleaning cable (4 pieces) in cable carrier for pipe-Ø 50–250 mm	32 × 4.5 m	174201
Pipe and drain cleaning cable S With thick special spring steel for high stability, e.g. during root cutting, milling, chain knocking for pipe-Ø 25–125 mm	16 × 2 m	171205
for pipe-Ø 50–150 mm	22 × 4 m	172205
for pipe-Ø 50–250 mm	32 × 4 m	174205
Pipe and drain cleaning cable with core prevents clogging of pipe and drain cleaning cable with dirt for pipe-Ø 25–125 mm	16 × 2.3 m	171210
for pipe-Ø 50–150 mm	22 × 4.5 m	172210
for pipe-Ø 50–250 mm	32 × 4.5 m	174210
Pipe and drain cleaning cable with core (5 pieces) in cable carrier for pipe-Ø 50–150 mm	22 × 4.5 m	172203
Pipe and drain cleaning cable with core (4 pieces) in cable carrier for pipe-Ø 50–250 mm	32 × 4.5 m	174203
Cable reduction 22/16 for connecting individual cables of different sizes	22/16	172154
Cable reduction 32/22 for connecting individual cables of different sizes	32/22	174154
Cable carrier (empty)	16	171150
	22	172150
	32	174150
Cable joint separator for releasing the safety lock	16	171151
	22/32	172151



Description	Size	Art.-No.
Straight auger for exploring the obstruction to withdraw a sample. Clearing of solid blockages caused by e.g. textiles, paper, kitchen waste	16 22 32	171250 172250 174250
Bulbous auger for minor obstructions caused by textiles and papers. Flexible, facilitates advancement in tight bends.	16 22 32	171265 172265 174265
Funnel auger for textile and paper obstructions in particular. Especially useful for cleaning larger diameter pipes. Also be used as a recovery tool for cables left in the pipe.	16 22 32	171270 172270 174270
Retrieving auger with extended, specially angled grappling arms. Used to recover cables left in the pipe. Not suitable for boring operations.	16 22 32	171275 172275 174275
Serrated blade borer for boring out greasy or heavily silted pipes, e.g. drains of washing machines, dishwashers. Riveted to the connector (not soldered or welded), so as to prevent any deformation of the hardened spring steel blades.	16/25 22/35 22/45 32/55	171280 172280 172281 174282
Serrated cross-blade borer Universal use for obstructions of all kinds, including incrustations, e.g. limescale deposits on the inside of the pipe. Riveted to the connector (not soldered or welded), so as to prevent any deformation of the hardened spring steel blades. Operation with pipe and drain cleaning cable S recommended.	16/25 16/35 22/35 22/45 22/65 32/45 32/65 32/90 32/115	171290 171291 172290 172291 172293 174291 174293 174295 174296
Forked cutter to remove moderate to severe silting or persistent grease contamination. Made of hardened spring steel.	16	171305
Cross-forked cutter to remove moderate to severe silting or persistent grease contamination. Made of hardened spring steel. Operation with pipe and drain cleaning cable S recommended.	16	171306
Serrated forked cutter Versatile use, e.g. for removal of slurries and for mincing (crushing) of root infested pipe. Made of hardened spring steel.	22/65 32/65 32/90	172305 174305 174306
Root cutter specially designed for root infested pipe. Hardened, replaceable ring-type saw, cutting to front and rear. Operation with pipe and drain cleaning cable S recommended.	22/65 32/65 32/90	172310 174310 174311
Chain knocker, smooth rings for final pipe and drain cleaning for removal of grease deposits and incrustations, e.g. limescale deposits on the inside of the pipe. For sensitive pipes, e.g. plastic.	16 22 32	171340 172340 174340
Chain knocker, spiked links for final pipe and drain cleaning for removal of grease deposits and incrustations, e.g. limescale deposits on the inside of the pipe. For cast and concrete pipes.	16 22 32	171341 172341 174341
Guide gloves, pair for secure gripping and guiding of pipe and drain cleaning cables		172610
Riveted guide glove, left Riveted guide glove, right for secure gripping and guiding of pipe and drain cleaning cables. Fully leather, inner surface riveted.		172611 172612



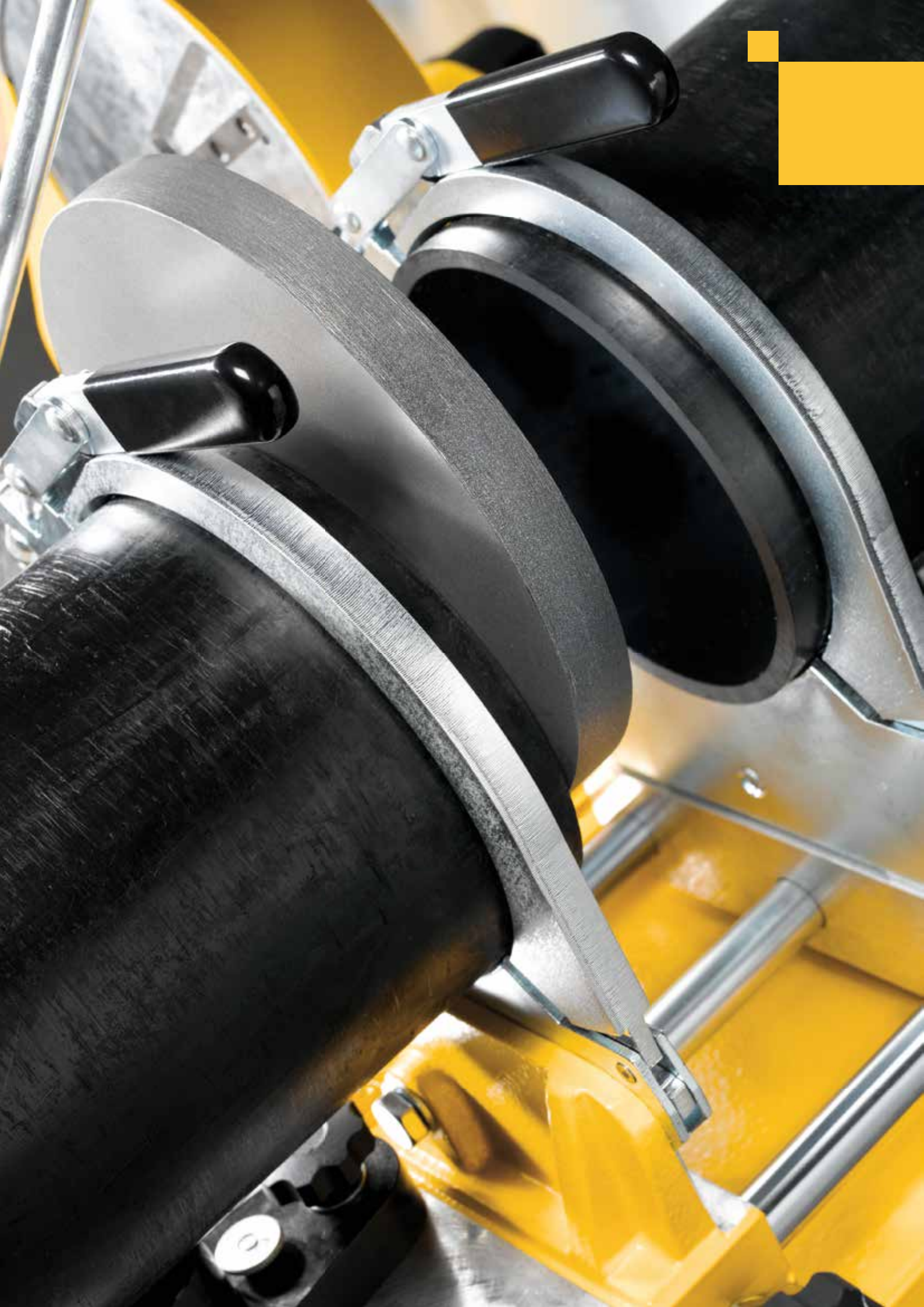

Plastic Pipe Welding



Electric sleeve welding unit

214



Sleeve welding units

215



Butt welding machines

216



Butt welding units

220

REMS EMSG 160

Electric sleeve welding unit

Powerful, handy unit for welding plastic drain pipes with electric sleeves in PE.

Plastic pipes and electric sleeves in PE Ø 40–160 mm

For Geberit, Akatherm-Euro, Coes, Valsir, Waviduo, Vulcathene-Euro

REMS EMSG 160 – automatic welding.
Electronic control. Acoustic and visual monitoring of welding process.

- Smallest sizes. Super-handy, light, only 0.7 kg. Can be used anywhere.
- Electronic control with micro controller for automatic adjustment of welding current (welding temperature) and welding time according to sleeve size.
- Automatic compensation of welding time in accordance with the ambient temperature.
- Acoustic and visual monitoring of welding process.
- Wide work radius through extra-long cables.
- Sturdy, shock-proof plastic casing with carrying strap. Splash-proof.



German Quality Product



Supply format

REMS EMSG 160. Electric sleeve welding unit 230 V, 50 Hz, 1150 W, for welding plastic drain pipes with electric sleeves in PE made by Akatherm-Euro, Coes, Geberit, Valsir, Waviduo, Vulcathene-Euro, Ø 40–160 mm. Electronic control, with acoustic and visual monitoring of welding process. In sturdy, shock-proof plastic casing. Welding leads 4.40 m. In a carton.

	Art.-No.	
	261001	

Accessories

Description	Art.-No.	
Case	151615	



Powerful electric tools for efficient sleeve welding.
Can be used anywhere, free-hand or on the work bench.

Plastic pipes and fittings
in PB, PE, PP, PVDF Ø 16–125 mm

REMS MSG – heating element according to DVS. High quality PTFE coating of heating spigots/sockets.

Design

Handy, light, safe. Free-hand or work bench assembly. Supplied in standard with supporting stand and bench support for mounting the unit in a horizontal or vertical position (bench support not supplied for MSG 25).

Heating element according to DVS

Plate-shaped, plane parallel heating element according to DVS. Electric heater embedded in corrosion-resistant cast aluminium for indirect heat transfer. Heating spigots and heating sockets according to DVS. High-quality, long-lasting PTFE coating prevents adherence of plastic remnants as well as oxidizing, and enables easy cleaning. Ideal temperature distribution and constant temperature at the complete working area. Fastening screws in stainless steel.

Temperature and temperature control

Choice of

- adjustable temperature 180–290°C, preadjusted to 260°C for PP pipes, with electronic temperature control with tight tolerance (EE) or
- fixed temperature to 260°C for PP pipes, with mechanical temperature control with a tolerance of +/- 10°C (FM).

The electronic and manual temperature control automatically controls the preadjusted temperature within the permitted range according to DVS. Temperature control lamp and power control lamp.



Supply format

REMS MSG. Sleeve welding unit for plastic pipes and fittings in PB, PE, PP, PVDF. Heating element 230 V, 50–60 Hz, without PTFE-coated heating spigots and heating sockets. Choice of adjustable temperature 180–290°C, preadjusted to 260°C for PP pipes, with electronic temperature control (EE) or fixed temperature to 260°C for PP pipes, with mechanical temperature control (FM). Support stand. Bench support for mounting the welding unit in a horizontal or vertical position (not for MSG 25). Hexagon key for assembly and dismantling of heating spigots and heating sockets. In a carton.

Description	Pipes Ø mm	Power W	Art.-No.
25 EE	16–25	500	256020
63 FM	16–63	800	256211
63 EE	16–63	800	256220
125 EE	16–125	1400	256320

Other voltages available.

Supply format

REMS MSG 63 FM Set. As REMS MSG 63 FM, but with PTFE-coated heating spigots, heating sockets for Ø 20, 25, 32 mm. Fastening screws in stainless steel. In steel case.

Description	Pipes Ø mm	Power W	Art.-No.
	16–63	800	256231

Other voltages available.

Supply format

REMS MSG 63 EE Set. As REMS MSG 63 EE, but with PTFE-coated heating spigots, heating sockets for Ø 20, 25, 32 mm. Fastening screws in stainless steel. In steel case.

Description	Pipes Ø mm	Power W	Art.-No.
	16–63	800	256240

Other voltages available.



Accessories

Description	Pipes Ø mm	Art.-No.
Heating spigot, heating socket, fastening screw in stainless steel	16	256400
	17	256410
	18	256420
	19	256430
	20	256440
	25	256450
	32	256460
	40	256470
	50	256480
	63	256490
	75	256500
	90	256510
	110	256520
125	256530	
Steel case		
REMS MSG 25		256042
REMS MSG 63		256242
REMS MSG 125		256342



REMS SSM 160RS

Butt welding machine

Handy, easy-to-carry compact machine. Complete only 48 kg. Ideal for sanitary installations and installation of drain pipes, chimney reconstruction with PVDF pipes. For job site and workshop.

Plastic pipes and fittings

in PB, PE, PP, PVDF

Ø 40–160 mm

PE Ø 40–90 mm	SDR ≥ 6
PE Ø 40–110 mm	SDR ≥ 9
PE Ø 40–125 mm	SDR ≥ 11
PE Ø 40–140 mm	SDR ≥ 17
PE Ø 40–160 mm	SDR ≥ 21

REMS SSM 160RS – ideal for the pipe fitter.
Light and compact. Heating element according to DVS. Electronic temperature control.
High-quality PTFE coating. Powerful facing cutter.
Closed facing cutter housing.

Design

Light and compact. Low weight, complete only 48 kg. Can be easily carried by one person.

- Base frame in cast aluminium
- Free suspension of butt welding unit REMS SSG 180 for exact alignment of the faces to be welded
- Electric facing cutter unit for plane-parallel machining of pipe ends
- Smooth sliding, roller-bearing mounting of butt welding unit and electric facing cutter unit
- Quick clamping device, also suitable for angular branches.
- Pressing device, clear scale for easy reading of jointing pressure, clamping handle for pressure holding
- Can be used on the workbench or on the tubular stand provided as standard (= sub-frame = transport device).

Heating element according to DVS

Plate-shaped, plane parallel heating element according to DVS. Electric heater embedded in corrosion-resistant cast aluminium for indirect heat transfer. High-quality, long-lasting PTFE coating prevents adherence of plastic remnants as well as oxidizing, and enables easy cleaning. Ideal temperature distribution and constant temperature at the complete working area. Protective cover for heating element.

Electronic temperature control

Adjustable temperature 180–290°C, preset for PE pipes. The electronic temperature control automatically controls the preset temperature within the permitted range according to DVS. Temperature control lamp and power control lamp.

Facing cutter unit

Electric facing cutter unit with special, high torque universal motor, 500 W, for plane-parallel machining of one or both pipe ends according to DVS. Fast positioning of facing cutter with proven safety switch. Closed facing cutter housing. Specially hardened and specially ground planing blades guarantee easy, vibration-free planing.

Quick clamping device, also for angular branches

Sturdy quick clamping device made of nickel-plated steel, consisting of 2 vices with 2 clamping inserts each for pipes of Ø 40, 50, 56, 63, 75, 90, 110, 125, 135, 140, 160 mm. Also suitable for angular branches.

Pipe supports

Multiple adjustment, easy positioning of pipe supports for pipes Ø 160 mm for supporting and easy axial alignment of pipes and fittings. 2 pipe support inserts each for pipes Ø 40, 50, 56, 63, 75, 90, 110, 125, 135, 140 mm.

Supply format

REMS SSM 160RS. Butt welding machine for plastic pipes and fittings in PB, PE, PP, PVDF, PE Ø 40–90 mm SDR ≥ 6, PE Ø 40–110 mm SDR ≥ 9, PE Ø 40–125 mm SDR ≥ 11, PE Ø 40–140 mm SDR ≥ 17, PE Ø 40–160 mm SDR ≥ 21. Butt welding unit with PTFE-coated heating element 230 V, 50–60 Hz, 1200 W. Adjustable temperature 180–290°C, preset for PE pipes. Electronic temperature control. Protective cover for heating element. Electric planing device 230 V, 50–60 Hz, 500 W. Pressing device. Quick clamping device, also for angular branches, consisting of 2 vices with 2 clamping inserts each Ø 40, 50, 56, 63, 75, 90, 110, 125, 135, 140, 160 mm. 2 pipe rests Ø 160 mm with pipe rest inserts Ø 40, 50, 56, 63, 75, 90, 110, 125, 135, 140 mm. Work key. Steel case for pipe support inserts and clamp inserts. Tubular stand = base frame = carrying device.

Art.-No.	
252026	

Accessories

Description	Art.-No.	
Planing blade (piece)	252103	



REMS SSM 160KS

Butt welding machine

Powerful, proven, easy-to-transport compact machine. Ideal for sanitary installation, drain pipe installation, chimney reconstruction with PVDF pipes. For job site and workshop.

Plastic pipes and fittings		
in PB, PE, PP, PVDF		Ø 40–160 mm
PE Ø 40–90 mm	SDR ≥ 6	
PE Ø 40–110 mm	SDR ≥ 9	
PE Ø 40–125 mm	SDR ≥ 11	
PE Ø 40–140 mm	SDR ≥ 17	
PE Ø 40–160 mm	SDR ≥ 21	

REMS SSM 160KS – ideal for the pipe fitter. Heating element according to DVS. Electronic temperature control. High-quality PTFE coating. Powerful facing cutter. Closed facing cutter housing.

Design

Compact, robust, job site-proven. Machine on sheet metal base weighs 90 kg. Easy to carry.

- Base frame in aluminium cast
- Free suspension of butt welding unit REMS SSG 180 for exact alignment of the faces to be welded
- Electric facing cutter unit for plane-parallel machining of pipe ends
- Smooth sliding, roller-bearing mounting of butt welding unit and electric facing cutter unit
- Quick clamping device, also suitable for angular branches.
- Pressing device, clear scale for easy reading of jointing pressure, clamping handle for pressure holding
- Machine on sheet steel base with built-in drawer for clamping and pipe rest inserts
- Suitable for use on a work bench or on the standard supplied sheet metal cabinet (= carrying case).

Heating element according to DVS

Plate-shaped, plane-parallel heating element according to DVS. Electric heater embedded in corrosion-resistant cast aluminium for indirect heat transfer. High-quality, long-lasting PTFE coating prevents adherence of plastic remnants as well as oxidizing, and enables easy cleaning. Ideal temperature distribution and constant temperature at the complete working area. Protective cover for heating element.

Electronic temperature control

Adjustable temperature 180–290°C, preset for PE pipes. The electronic temperature control automatically controls the preset temperature within the permitted range according to DVS. Temperature control lamp and power control lamp.

Facing cutter unit

Electric facing cutter unit with special, high torque universal motor, 500 W, for plane-parallel machining of one or both pipe ends according to DVS. Fast positioning of facing cutter with proven safety switch. Closed facing cutter housing. Specially hardened and specially ground planing blades guarantee easy, vibration-free planing.

Quick clamping device, also for angular branches

Sturdy quick clamping device made of nickel-plated steel, consisting of 2 vices with 2 clamping inserts each for pipes of Ø 40, 50, 56, 63, 75, 90, 110, 125, 135, 140, 160 mm. Also suitable for angular branches.

Pipe supports

Multiple adjustment, easy positioning of pipe supports for pipes of Ø 160 mm for supporting and easy axial alignment of pipes and fittings. 2 pipe support inserts each for pipes Ø 40, 50, 56, 63, 75, 90, 110, 125, 135, 140 mm.

Supply format

REMS SSM 160KS. Butt welding machine for plastic pipes and fittings in PB, PE, PP, PVDF, PE Ø 40–90 mm SDR ≥ 6, PE Ø 40–110 mm SDR ≥ 9, PE Ø 40–125 mm SDR ≥ 11, PE Ø 40–140 mm SDR ≥ 17, PE Ø 40–160 mm SDR ≥ 21. Butt welding unit with PTFE-coated heating element 230 V 50–60 Hz, 1200 W. Adjustable temperature 180–290°C, preset for PE pipes. Electronic temperature control. Protective cover for heating element. Electric planing device 230 V, 50–60 Hz, 500 W. Pressing device. Quick clamping device, also for angular branches, consisting of 2 vices with 2 clamping inserts each Ø 40, 50, 56, 63, 75, 90, 110, 125, 135, 140, 160 mm. 2 pipe rests Ø 160 mm with pipe rest inserts Ø 40, 50, 56, 63, 75, 90, 110, 125, 135, 140 mm. Sheet steel base with built-in drawer. Work key. Closed sheet metal cabinet = carrying case.

	Art.-No.	
	252046	

Accessories

Description	Art.-No.	
Planing blade (piece)	252103	



REMS SSM 250KS

Butt welding machine

Powerful, proven, easy-to-transport compact machine. Ideal for sanitary installation, drain pipe installation, chimney reconstruction with PVDF pipes. For job site and workshop.

Plastic pipes and fittings

in PB, PE, PP, PVDF

Ø 75–250 mm

PE Ø 75–140 mm	SDR ≥ 6
PE Ø 75–160 mm	SDR ≥ 9
PE Ø 75–180 mm	SDR ≥ 11
PE Ø 75–200 mm	SDR ≥ 13.6
PE Ø 75–225 mm	SDR ≥ 17.6
PE Ø 75–250 mm	SDR ≥ 22

REMS SSM 250KS – compact and robust.

Design

Compact, robust, job site-proven. Easy to carry. Machine on sheet metal base weighs 109 kg.

- Base frame in aluminium cast
- Free suspension of butt welding unit for exact alignment of the faces to be welded
- Electric facing cutter unit for plane-parallel machining of pipe ends
- Smooth sliding, roller-bearing mounting of butt welding unit and electric facing cutter unit
- Quick clamping device, also suitable for angular branches.
- Pressing device, clear scale for easy reading of jointing pressure, clamping handle for pressure holding
- Machine on sheet steel base with built-in drawer for clamping and pipe rest inserts.
- Suitable for use on a work bench or on the standard supplied sheet metal cabinet (= carrying case).

Heating element according to DVS

Plate-shaped, plane-parallel heating element according to DVS. Electric heater embedded in corrosion-resistant cast aluminium for indirect heat transfer. High-quality, long-lasting PTFE coating prevents adherence of plastic remnants as well as oxidizing, and enables easy cleaning. Ideal temperature distribution and constant temperature at the complete working area.

Electronic temperature control

Adjustable temperature 180–290°C, preset for PE pipes. The electronic temperature control automatically controls the preset temperature within the permitted range according to DVS. Temperature control lamp and power control lamp.

Facing cutter unit

Electric facing cutter unit with special, high torque universal motor, 500 W, for plane-parallel machining of one or both pipe ends according to DVS. Fast positioning of facing cutter with proven safety switch. Closed facing cutter housing. Specially hardened and specially ground planing blades guarantee easy, vibration-free planing.

Quick clamping device for angular branches

Sturdy quick clamping device made of nickel-plated steel which grips the pipe all round, consisting of 2 clamps Ø 250 mm with jaws Ø 250 mm, with 2 clamping jaws and 2 clamping inserts each for pipes of Ø 75, 90, 110, 125, 160, 200 mm. Also suitable for angular branches. Clamping jaws and clamping inserts available for pipes of Ø 140, 180, 225 mm.

Pipe supports

Multiple adjustment, easy positioning of pipe supports for supporting and easy axial alignment of pipes and fittings. 2 pipe support inserts each for pipes Ø 75, 90, 110, 125, 140, 160, 180, 200, 225, 250 mm. Pipe rest inserts available for pipes of Ø 140, 180, 225 mm.

Supply format

REMS SSM 250K. Butt welding machine for plastic pipes and fittings in PB, PE, PP, PVDF. PE Ø 75–140 mm SDR ≥ 6, PE Ø 75–160 mm SDR ≥ 9, PE Ø 75–180 mm SDR ≥ 11, PE Ø 75–200 mm SDR ≥ 13.6, PE Ø 75–225 mm SDR ≥ 17.6, PE Ø 75–250 mm SDR ≥ 22. Butt welding unit with PTFE-coated heating element 230 V, 50–60 Hz, 1300 W. Adjustable temperature 180–290°C, preset for PE pipes. Electronic temperature control. Electric facing cutter unit 230 V, 50–60 Hz, 500 W. Quick clamping device, also for angular branches, consisting of 2 clamps Ø 250 mm with jaws Ø 250 mm, with 2 clamping jaws and 2 clamping inserts each for pipes of Ø 75, 90, 110, 125, 160, 200 mm. 2 pipe rests with pipe rest inserts Ø 75, 90, 110, 125, 160, 200, 250 mm. Sheet steel base with built-in drawer. Work key. Closed sheet metal cabinet = carrying case.

	Art.-No.
	254025

Accessories

Description	Art.-No.
Planing blade (piece)	254103



REMS SSM 315RF

Butt welding machine

Compact, easy-to-transport high-performance machine for sanitary installation, drain pipe installation, chimney reconstruction with PVDF pipes. For job site and workshop.

Plastic pipes and fittings

in PB, PE, PP, PVDF Ø 90–315 mm

PE Ø 90–180 mm	SDR ≥ 6
PE Ø 90–200 mm	SDR ≥ 7,4
PE Ø 90–225 mm	SDR ≥ 9
PE Ø 90–250 mm	SDR ≥ 13,6
PE Ø 90–280 mm	SDR ≥ 17
PE Ø 90–315 mm	SDR ≥ 21

REMS SSM 315RF – convenient for job site and workshop.

Design

Compact, robust, job site-proven. Weight including tubular stand on wheels 154 kg.

- Base frame in aluminium cast
- Free suspension of butt welding unit for exact alignment of the faces to be welded
- Electric facing cutter unit for plane-parallel machining of pipe ends
- Smooth sliding, roller-bearing mounting of butt welding unit and electric facing cutter unit
- Quick clamping device
- Pressing device, clear scale for easy reading of jointing pressure, clamping handle for pressure holding
- Standard supply with tubular wheel stand for secure standing and easy transport.

Heating element according to DVS

Plate-shaped, plane-parallel heating element according to DVS. Electric heater embedded in corrosion-resistant cast aluminium for indirect heat transfer. High-quality, long-lasting PTFE coating prevents adherence of plastic remnants as well as oxidizing, and enables easy cleaning. Ideal temperature distribution and constant temperature at the complete working area.

Electronic temperature control

Adjustable temperature 180–290°C, preset for PE pipes. The electronic temperature control automatically controls the preset temperature within the permitted range according to DVS. Temperature control lamp and power control lamp.

Facing cutter unit

Electric facing cutter unit with special, high torque universal motor, 500 W, for plane-parallel machining of one or both pipe ends according to DVS. Fast positioning of facing cutter with proven safety switch. Closed facing cutter housing. Specially hardened and specially ground planing blades guarantee easy, vibration-free planing.

Quick clamping device

Sturdy quick clamping devices made of nickel-plated steel which grip the pipe all round, for pipes of Ø 315 mm. 4 clamping inserts each for pipes of Ø 90, 110, 125, 160, 200, 250 mm. Clamping inserts available for pipes of Ø 140, 180, 225, 280 mm.

Pipe supports

Multiple adjustment, easy positioning of pipe supports for pipes Ø 315 mm for supporting and easy axial alignment of pipes and fittings. 2 pipe rest inserts each for pipes of Ø 90, 110, 125, 160, 200, 250 mm. Pipe rest inserts available for pipes of Ø 140, 180, 225, 280 mm.



Supply format

REMS SSM 315RF. Butt welding machine for plastic pipes and fittings in PB, PE, PP, PVDF. PE Ø 90–180 mm SDR ≥ 6, PE Ø 90–200 mm SDR ≥ 7,4, PE Ø 90–225 mm SDR ≥ 9, PE Ø 90–250 mm SDR ≥ 13,6, PE Ø 90–280 mm SDR ≥ 17, PE Ø 90–315 mm SDR ≥ 21. Butt welding unit with PTFE-coated heating element 230 V, 50–60 Hz, 3000 W. Adjustable temperature 180–290°C, preset for PE pipes. Electronic temperature control. Electric facing cutter unit 230 V, 50–60 Hz, 500 W. Pressing device. 2 quick clamping devices Ø 315 mm with 2 clamping inserts each for pipes of Ø 90, 110, 125, 160, 200, 250 mm. 2 pipe supports Ø 315 mm with pipe support inserts Ø 90, 110, 125, 160, 200, 250 mm. Ring spanner. Boxes for clamping and pipe rest inserts. Tubular stand on wheels.

	Art.-No.
	255020

Accessories

Description	Art.-No.
Planing blade (piece)	255103



Powerful electric tools for efficient butt welding.
Can be used anywhere, free-hand or on the work bench.

Plastic pipes and fittings
in PB, PE, PP, PVDF $\varnothing \leq 280 \text{ mm}$

REMS SSG – heating element according to DVS.
Electronic temperature control.
High-quality PTFE coating.

Design

Handy, light, safe. Free-hand or work bench assembly. Supplied as standard with supporting stand. Bench support available as accessory for mounting the unit in a horizontal or vertical position.

Heating element according to DVS

Plate-shaped, plane parallel heating element according to DVS. Electric heater embedded in corrosion-resistant cast aluminium for indirect heat transfer. High-quality, long-lasting PTFE coating prevents adherence of plastic remnants as well as oxidizing, and enables easy cleaning. Ideal temperature distribution and constant temperature at the complete working area.

Electronic temperature control

Adjustable temperature 180–290°C, preset for PE pipes. The electronic temperature control automatically controls the preset temperature within the permitted range according to DVS. Temperature control lamp and power control lamp.

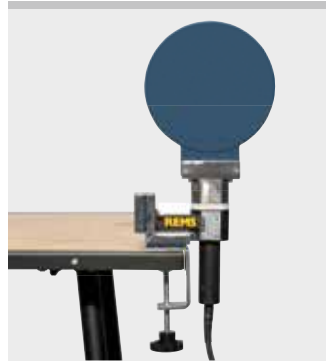

Supply format

REMS MSG. Butt welding unit for plastic pipes and fittings in PB, PE, PP, PVDF. PTFE-coated heating element 230 V, 50–60 Hz. Adjustable temperature 180–290°C, preset for PE pipes. Electronic temperature control. Support stand. In a carton.

Description	Heating element \varnothing mm	Pipes $\varnothing \leq$ mm	Power W	Art.-No.
110/45° EE	125	110	500	250020
125 EE	145	125	700	250120
180 EE	200	180	1200	250220
280 EE	300	280	1300	250320

Accessories

Description	Art.-No.
Bench support for mounting the unit in a horizontal or vertical position REMS SSG 110/45°, 125, 180 REMS SSG 280	250041 250341
Steel case REMS SSG 110/45° REMS SSG 125 REMS SSG 180 REMS SSG 280	250042 250142 250242 250342
Protection cover for heating element REMS SSG 110, 110/45°, 125 REMS SSG 180 REMS SSG 280	250143 250243 250343









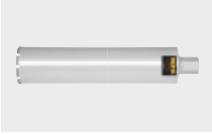

Diamond core drilling

Diamond chasing and cutting machine

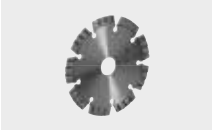
Wet and dry suction

	Electric diamond core drilling machines	224
	Drill stands	232
	Universal diamond core drilling crowns	234
	Universal diamond core drilling crowns LS	235
	Tile drilling	236
	Diamond chasing and cutting machines	238
	Diamond cutting discs	239
	Dry and wet extractor	240

Compact, handy power tool for core drilling, e.g. in concrete, steel-reinforced concrete, all kinds of masonry, natural stone, asphalt, all kinds of screed. Dry or wet drilling, hand held or with drill stand. For trade and industry.

Concrete, steel-reinforced concrete	up to Ø 102 (132) mm
Masonry and others	up to Ø 162 mm

REMS Universal diamond core drilling crowns, also suitable for drive machines of other makes, see page 234–235.

REMS Picus S1 – Core drilling instead of chiselling. Easy, fast, vibration-free.

1 system – 4 applications. Ideal for plumbers.

Universal use

Universal drive machine for dry or wet drilling, hand held or with drill stand. Can be used anywhere, in narrow angles, flush with the wall. For many materials. For pipeline and cable ducting, ventilation channels, test core drilling.

System advantage

Only **one** type of universal diamond core drilling crowns for all REMS Picus drive machines and other suitable makes of drive machines. Therefore simple, low cost storage. No confusion possible.

Design

Compact, handy drive machine for vibration-free core drilling, with drilling crown connecting thread UNC 1¼ male, BSPP ½ female. Robust, suitable for the building site. Extra light, only 5.2 kg. Simple, fast work, e.g. 200 mm in steel-reinforced concrete Ø 62 mm in only 3 min. Practical spade handle and stabiliser for hand held drilling. Throat Ø 60 mm for holding the drive machine in the drill stand. Water supply for wet drilling, with adjustable shut-off valve and quick-coupling with water stop and hose connection ½". Suction rotor for sucking off dust for dry drilling with connection for conventional vacuum cleaner, as accessory.

Drive

Robust, powerful 1850 W universal motor. Load speed drilling spindle 580 rpm. Stable, maintenance-free gear. Blocking protection by safety slip clutch. Tip switch with lock. Connecting cable with integrated personal protection switch (PRCD).

Multifunction electronics

Multifunction electronics with start-up current limiting for soft starting for delicate drilling start, automatic idle speed limiting for noise reduction and preservation of the motor, overload and blocking protection for motor and gear.

Universal diamond core drilling crowns

Universally usable for dry and wet drilling, hand held or with drill stand. Optionally REMS Universal diamond core drilling crowns, inductively soldered, resolderable or REMS Universal diamond core drilling crowns LS, laser welded, high temperature-resistant (page 234–235). Connecting thread UNC 1¼ female. Drilling depth

420 mm. Specially developed, high quality diamond segments with high diamond percentage and special bonding, for excellent drilling performance and very long life. Ideal for universal applications in steel-reinforced concrete and masonry. Adapter for using the REMS Universal diamond core drilling crowns in drive machines of other makes, as accessory. Light loosening ring, for light loosening of the diamond core crown, as accessory.

Dust extraction in accordance with EN 60335-2-69

When working with mineral building materials, e.g. concrete, steel-reinforced concrete, masonry and screed, a high degree of mineral dust containing quartz is produced which is harmful to the health. Inhalation of quartz fine dust is harmful to the health. EN 60335-2-69 prescribes the use of at least one safety extractor of dust class M for the extraction of health hazardous dusts with an exposure limit/work place limit of > 0.1 mg/m³. Observe the national regulations.

Suction rotor for dust extraction in dry drilling with connection for REMS Pull and other suitable extractors, as accessory. REMS Pull M, wet and dry dust extractor, certified for extracting health hazardous dusts of dust class M, see page 240.

Water extractor unit

Water extractor unit for wet drilling up to Ø 170 mm, consisting of a water collector ring with connection for REMS Pull or other suitable wet extractors, compression ring, rubber washer Ø 200 mm, adaptable to diameter of the drill crown and universal pressure pad for all REMS drill stands, as accessory.

Drill stand

REMS Simplex 2 or REMS Titan drill stands can be used optionally, see page 232.



REMS Simplex 2



REMS Titan



REMS Picus S1 Basic-Pack



REMS Picus S1 Set 62

Supply format

REMS Picus S1 Basic-Pack. Electric diamond core drilling machine for core drilling in concrete, steel-reinforced concrete up to Ø 102 (132) mm, masonry and other materials up to Ø 162 mm. For dry and wet drilling, hand held or with drill stand. Drive machine with drilling crown connecting thread UNC 1¼ male, BSPP ½ female, maintenance-free gear with safety slip clutch, universal motor 230 V, 50–60 Hz, 1850 W. Multifunction electronics with soft starting, idle speed limiting, overload protection, blocking protection. Touch switch with lock. Personal protection switch (PRCD). Load speed drilling spindle 580 rpm. Water supply device with adjustable shut-off valve and quick coupling with water stop and ½" hose connection. Stabiliser. Starting aid BSPP ½ with drill Ø 8 mm, Allen key size 3. Single open-ended wrench size 32. In sturdy steel case.

	Art.-No.	
	180010	

Other voltages on request.

Supply format

REMS Picus S1 Set 62. REMS Picus S1 Basic-Pack with REMS Universal diamond core drilling crown UDKB Ø 62 mm.

	Art.-No.	
	180020	

Other voltages on request.

Supply format

REMS Picus S1 Set 62 Simplex 2. REMS Picus S1 Basic-Pack with REMS Universal diamond core drilling crowns UDKB Ø 62 mm a REMS Simplex 2 drilling stand including tools and fastening kit for masonry and concrete.

	Art.-No.	
	180031	

Other voltages on request.



REMS Picus S1 Set 62 Simplex 2

Accessories

Description	Art.-No.	
REMS Picus S1 drive unit	180000	
Steel case with inlay	180600	
REMS Universal diamond core drilling crowns , inductively soldered, resolderable, see page 234.		
REMS universal diamond core drilling crowns LS , laser welded, high temperature-resistant, see page 235.		
REMS Pull L / M , dry and wet extractors, see page 240		
Additional accessories see page 232–233.		



Powerful, handy power tool for core drilling, e.g. in concrete, steel-reinforced concrete, all kinds of masonry, natural stone, asphalt, all kinds of screed. Dry or wet drilling, hand held or with drill stand. For trade and industry.

Concrete, steel-reinforced concrete	up to Ø 152 (200) mm
Masonry and others	up to Ø 250 mm

REMS Universal diamond core drilling crowns, also suitable for drive machines of other makes, see page 234–235.

REMS Picus S3 – Core drilling instead of chiselling. Easy, fast, vibration-free.

1 system – 4 applications. Ideal for plumbers.

Universal use

Universal drive machine for dry or wet drilling, hand held or with drill stand. Can be used anywhere, in narrow angles, flush with the wall. Extremely versatile and efficient, e.g. drilling in steel-reinforced concrete, masonry and other materials. For pipeline and cable ducting, ventilation channels, test core drilling.

System advantage

Only **one** type of universal diamond core drilling crowns for all REMS Picus drive machines and other suitable makes of drive machines. Therefore simple, low cost storage. No confusion possible.

Design

Compact, handy drive machine for vibration-free core drilling, with drilling crown connecting thread UNC 1¼ male, BSPP ½ female. Robust, suitable for the building site. Only 7.4 kg. Simple, fast work, e.g. 200 mm in steel-reinforced concrete Ø 62 mm in only 3 min. Practical spade handle and stabiliser for hand held drilling. Throat Ø 60 mm for holding the drive machine in the drill stand. Water supply for wet drilling, with adjustable shut-off valve and quick-coupling with water stop and hose connection ½". Suction rotor for sucking off dust for dry drilling with connection for conventional vacuum cleaner, as accessory.

Drive

Robust, powerful 2200 W universal motor. Stable, maintenance-free 3-speed gear for optimum selection of load speed according to the drilling diameter. Load speed drilling spindle 530 rpm, 1280 rpm, 1780 rpm. Blocking protection by safety slip clutch. Tip switch with lock. Connecting cable with integrated personal protection switch (PRCD).

Multifunction electronics

Multifunction electronics with start-up current limiting for soft starting for delicate drilling start, automatic idle speed limiting for noise reduction and preservation of the motor, overload and blocking protection for motor and gear.

Universal diamond core drilling crowns

Universally usable for dry and wet drilling, hand held or with drill stand. Optionally REMS Universal diamond core drilling crowns, inductively soldered, resolderable or REMS Universal diamond core drilling crowns LS, laser welded, high temperature-resistant (page 234–235). Connecting thread UNC 1¼ female. Drilling depth

420 mm. Specially developed, high quality diamond segments with high diamond percentage and special bonding, for excellent drilling performance and very long life. Ideal for universal applications in steel-reinforced concrete and masonry. Adapter for using the REMS Universal diamond core drilling crowns in drive machines of other makes, as accessory. Light loosening ring, for light loosening of the diamond core crown, as accessory.

Dust extraction in accordance with EN 60335-2-69

When working with mineral building materials, e.g. concrete, steel-reinforced concrete, masonry and screed, a high degree of mineral dust containing quartz is produced which is harmful to the health. Inhalation of quartz fine dust is harmful to the health. EN 60335-2-69 prescribes the use of at least one safety extractor of dust class M for the extraction of health hazardous dusts with an exposure limit/work place limit of > 0.1 mg/m³. Observe the national regulations.

Suction rotor for dust extraction in dry drilling with connection for REMS Pull and other suitable extractors, as accessory. REMS Pull M, wet and dry dust extractor, certified for extracting health hazardous dusts of dust class M, see page 240.

Water extractor unit

Water extractor unit for wet drilling up to Ø 170 mm, consisting of a water collector ring with connection for REMS Pull or other suitable wet extractors, compression ring, rubber washer Ø 200 mm, adaptable to diameter of the drill crown and universal pressure pad for all REMS drill stands, as accessory.

Drill stand

REMS Simplex 2 or REMS Titan drill stands can be used optionally, see page 232.



REMS Simplex 2



REMS Titan



REMS Picus S3 Basic-Pack



REMS Picus S3 Set Titan



REMS Picus S3 Set 62-82-132 Titan

Supply format

REMS Picus S3 Basic-Pack. Electric diamond core drilling machine for core drilling in concrete, steel-reinforced concrete up to Ø 152 (200) mm, masonry and other materials up to Ø 250 mm. For dry and wet drilling, hand held or with drill stand. Drive machine with drilling crown connecting thread UNC 1¼ male, BSPP ½ female, maintenance-free 3-speed gear with safety slip clutch, universal motor 230 V, 50–60 Hz, 2200 W. Multifunction electronics with soft starting, idle speed limiting, overload protection, blocking protection. Touch switch with lock, personal protection switch (PRCD). Load speed drilling spindle 530 rpm, 1280 rpm, 1780 rpm. Water supply with adjustable shut-off valve and quick-coupling with water stop and hose connection ½". Stabiliser. Starting aid BSPP ½, Allen key size 3. Single open-ended wrench size 32. In sturdy steel case.

	Art.-No.	
	180011	

Other voltages on request.

Supply format

REMS Picus S3 Set Titan. REMS Picus S3 Basic-Pack with REMS Titan drilling stand including fastening kit for masonry and concrete.

	Art.-No.	
	180029	

Other voltages on request.

Supply format

REMS Picus S3 Set 62-82-132 Titan. REMS Picus S3 Basic-Pack with REMS Universal diamond core drilling crowns UDKB Ø 62-82-132 mm and REMS Titan drilling stand including fastening kit for masonry and concrete.

	Art.-No.	
	180028	

Other voltages on request.

Accessories

Description	Art.-No.	
REMS Picus S3 drive unit	180001	
Steel case with inlay	180600	
REMS Universal diamond core drilling crowns , inductively soldered, resolderable, see page 234.		
REMS universal diamond core drilling crowns LS , laser welded, high temperature-resistant, see page 235.		
REMS Pull L / M , dry and wet extractors, see page 240		
Additional accessories see page 232–233.		

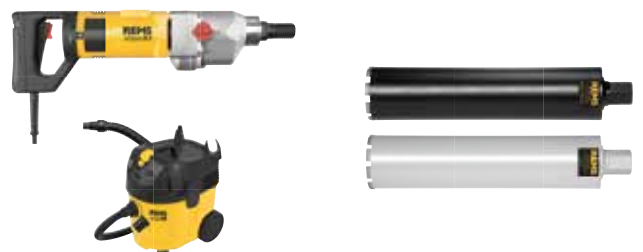

Compact, handy power tool for core drilling, e.g. in concrete, steel-reinforced concrete, all kinds of masonry, natural stone, asphalt, all kinds of screed. With speed regulation. Dry or wet drilling, hand held or with drill stand. For trade and industry.

Concrete, steel-reinforced concrete	up to Ø 162 (200) mm
Masonry and others	up to Ø 250 mm

REMS Universal diamond core drilling crowns, also suitable for drive machines of other makes, see page 234–235.

REMS Picus SR – Core drilling instead of chiselling. Easy, fast, vibration-free. With speed regulation.

1 system – 4 applications. Ideal for plumbers.

Universal use

Universal drive machine for dry or wet drilling, hand held or with drill stand. Can be used anywhere, in narrow angles, flush with the wall. Extremely versatile and efficient, e.g. drilling in steel-reinforced concrete, masonry and other materials. For pipeline and cable ducting, ventilation channels, test core drilling.

System advantage

Only **one** type of universal diamond core drilling crowns for all REMS Picus drive machines and other suitable makes of drive machines. Therefore simple, low cost storage. No confusion possible.

Design

Compact, handy drive machine for vibration-free core drilling, with drilling crown connecting thread UNC 1¼ male, BSPP ½ female. Robust, suitable for the building site. Extra light, only 6.4 kg. Simple, fast work, e.g. 200 mm in steel-reinforced concrete Ø 62 mm in only 3 min. Practical spade handle and stabiliser for hand held drilling. Throat Ø 60 mm for holding the drive machine in the drill stand. Water supply for wet drilling, with adjustable shut-off valve and quick-coupling with water stop and hose connection ½". Suction rotor for sucking off dust for dry drilling with connection for conventional vacuum cleaner, as accessory.

Drive

Robust, powerful 2200 W universal motor. Overheating protection by temperature monitoring of the motor's field winding with a PTC resistor (Positive Temperature Coefficient). Stable, maintenance-free, 2-step gear. Blocking protection by safety slip clutch. Tip switch with lock. Connecting cable with integrated personal protection switch (PRCD).

Speed-Regulation

Stepless electronic speed regulation of the drive machine for selecting the speed according to the material. The speed is steplessly adjustable on the dial: 250 rpm to 500 rpm (1st gear) or 600 rpm to 1200 rpm (2nd gear). The electronic speed control that is being used keeps the selected speed constant, also under load. Advantage: The optimum drilling speed (load speed) selected for the respective material and the drilling crown diameter remains constant for the entire duration of the drilling. For the best drilling performance and maximum life of the drilling crowns.

Multifunction electronics

Multifunction electronics with start-up current limiting for soft starting for delicate drilling start, automatic idle speed limiting for noise reduction and preservation of the motor, overload and blocking protection for motor and gear.

Universal diamond core drilling crowns

Universally usable for dry and wet drilling, hand held or with drill stand. Optionally REMS Universal diamond core drilling crowns, inductively soldered, resolderable or REMS Universal diamond core drilling crowns LS, laser welded, high temperature-resistant (page 234–235). Connecting thread UNC 1¼ female. Drilling depth 420 mm. Specially developed, high quality diamond segments with high diamond percentage and special bonding, for excellent drilling performance and very long life. Ideal for universal applications in steel-reinforced concrete and masonry. Adapter for using the REMS Universal diamond core drilling crowns in drive machines of other makes, as accessory. Light loosening ring, for light loosening of the diamond core crown, as accessory.

Drill stand

REMS Simplex 2 or REMS Titan drill stands can be used optionally, see page 232.

Dust extraction in accordance with EN 60335-2-69

When working with mineral building materials, e.g. concrete, steel-reinforced concrete, masonry and screed, a high degree of mineral dust containing quartz is produced which is harmful to the health. Inhalation of quartz fine dust is harmful to the health. EN 60335-2-69 prescribes the use of at least one safety extractor of dust class M for the extraction of health hazardous dusts with an exposure limit/work place limit of > 0.1 mg/m³. Observe the national regulations.

Suction rotor for dust extraction in dry drilling with connection for REMS Pull and other suitable extractors, as accessory. REMS Pull M, wet and dry dust extractor, certified for extracting health hazardous dusts of dust class M, see page 240.



Tested by electrosuisse >>

German Quality Product

With speed regulation for the best drilling performance and maximum life of the drilling crowns.



REMS Simplex 2



REMS Titan

REMS Picus SR

Electric diamond core drilling machine with speed regulation

Water extractor unit

Water extractor unit for wet drilling up to Ø 170 mm, consisting of a water collector ring with connection for REMS Pull or other suitable wet extractors, compression ring, rubber washer Ø 200 mm, adaptable to diameter of the drill crown and universal pressure pad for all REMS drill stands, as accessory.



REMS Picus SR Basic-Pack



REMS Picus SR Set Titan



REMS Picus SR Set 62-82-132 Titan

Supply format

REMS Picus SR Basic-Pack. For core drilling in concrete, steel-reinforced concrete up to Ø 162 (200) mm, masonry and other materials up to Ø 250 mm. For dry or wet drilling, hand held or with drill stand. Drive machine with drilling crown connection thread UNC 1¼ male, G ½ female, maintenance-free 2-step gear with safety slip clutch, universal motor 230 V, 50–60 Hz, 2200 W. Stepless electronic speed regulation 250 rpm to 500 rpm (1st gear) or 600 rpm to 1200 rpm (2nd gear), overheating protection. Multifunction electronics with soft starting, idle speed limiting, overload protection, blocking protection. Touch switch with lock. Personal protection switch (PRCD). Water supply device with adjustable shut-off valve and quick coupling with water stop and ½" hose connection. Stabiliser. Spacer set. Single open ended wrench size 32. In sturdy steel case.

	Art.-No.	
	183010	

Other voltages on request.

Supply format

REMS Picus SR Set Titan. REMS Picus SR Basic-Pack with REMS Titan drilling stand including fastening kit for masonry and concrete.

	Art.-No.	
	183022	

Other voltages on request.

Supply format

REMS Picus SR Set 62-82-132 Titan. REMS Picus SR Basic-Pack with REMS Titan drilling stand including fastening kit for masonry and concrete and REMS Universal diamond core drilling crowns UDKB Ø 62-82-132 mm.

	Art.-No.	
	183023	

Other voltages on request.

Accessories

Description	Art.-No.	
REMS Picus SR drive unit	183000	
Spacer set , for additional fastening of the REMS Picus SR drive machine to the REMS Titan drilling stand, consisting of spacer and two M 8 x 65 cylinder head screws	183632	
Steel case with inlay	180600	
REMS Universal diamond core drilling crowns , inductively soldered, resolderable, see page 234.		
REMS universal diamond core drilling crowns LS , laser welded, high temperature-resistant, see page 235.		
REMS Pull L / M , dry and wet extractors, see page 240		
Additional accessories see page 232–233.		



REMS Picus S2/3,5

Electric diamond core drilling machine

Powerful, robust core drilling machine for core drilling, e.g. in concrete, steel-reinforced concrete, all kinds of masonry, natural stone, asphalt, all kinds of screed. Dry or wet drilling with drill stand. For installation, metalwork, industry.

Concrete, steel-reinforced concrete, masonry and others Ø 40–300 mm

REMS Universal diamond core drilling crowns, also suitable for drive machines of other makes, see page 234–235.

REMS Picus S2/3,5 – Core drilling instead of chiselling. Easy, fast, vibration-free.

Universal use

Universal drive machine for dry or wet drilling, hand held or with drill stand. Can be used anywhere, in narrow angles, flush with the wall. Extremely versatile and efficient, e.g. drilling in steel-reinforced concrete, masonry and other materials. For pipeline and cable ducting, ventilation channels, test core drilling.

System advantage

Only one type of universal diamond core drilling crowns for all REMS Picus drive machines and other suitable makes of drive machines. Therefore simple, low cost storage. No confusion possible.

Design

Compact, handy drive machine for vibration-free core drilling, with drilling crown connecting thread UNC 1¼ male. Light loosening ring, for light loosening of the diamond core crowns. Compact, robust, suitable for the building site. Weight just 14.4 kg. Simple, fast work, e.g. 200 mm in steel-reinforced concrete Ø 62 mm in only 2 min. Clamping plate for fast clamping to the drill stand. Water supply for wet drilling, with adjustable shut-off valve and quick coupling with water stop and hose connection ½".

Drive

Robust, powerful 3420 W universal motor. Stable, maintenance-free 2-speed gear for optimum selection of load speed according to the drilling diameter. Load speed drilling spindle 320 rpm, 760 rpm. Blocking protection by safety slip clutch. Rocker switch. Connecting cable with integrated personal protection switch (PRCD).

Multifunction electronics

Multifunction electronics with start-up current limiting for soft starting for delicate drilling start, automatic idle speed limiting for noise reduction and preservation of the motor, overload and blocking protection for motor and gear.

Universal diamond core drilling crowns

Universally usable for dry and wet drilling, hand held or with drill stand. Optionally REMS Universal diamond core drilling crowns, inductively soldered, resolderable or REMS Universal diamond core drilling crowns LS, laser welded, high temperature-resistant (page 234–235). Connecting thread UNC 1¼ female. Drilling depth 420 mm. Specially developed, high quality diamond segments with high diamond percentage and special bonding, for excellent drilling performance and very long life. Ideal for universal applications in steel-reinforced concrete and masonry. Adapter for using the REMS Universal diamond core drilling crowns in drive machines of other makes, as accessory. Light loosening ring, for light loosening of the diamond core crown, as accessory.

Water extractor unit

Water extractor unit for wet drilling up to Ø 170 mm, consisting of a water collector ring with connection for REMS Pull or other suitable wet extractors, compression ring, rubber washer Ø 200 mm, adaptable to diameter of the drill crown and universal pressure pad for all REMS drill stands, as accessory.

Drill stand REMS Titan

Robust, highly stable drilling stand for core drilling in steel-reinforced concrete and other materials up to Ø 300 mm. For high demands. Drill column made of rigid, unbendable square precision steel tube \varnothing 50 mm, with extra narrow tolerance, for low-vibration guiding of the slide. Continuously tiltable with degree scale up to 45°, with double support by adjustable, single-part steel girders, for maximum thrust pressure. Highly stable, 3-sided guidance of the drill column in the base plate and triple cross fastening for high rigidity in vertical drilling. 4 Eyebolts for levelling unevenness of the floor, for exact standing position. Drill depth scale. Slide guided on all sides by adjustable, pretensioned plastic slide bearings. Precision in-feed drive ensures easy, low-vibration drilling and precise, low-vibration drill thrust. For high thrust pressure and long life of the drilling crowns. Spirit level integrated in the slide for exact alignment of the drill stand. Locking of the slide for simple assembly of the drilling crown and safe transport. Rigid connection plate made of wear-resistant spheroidal iron. Quick-clamping device for accommodating drive units with a suitable connection plate. Highly stable clamping bracket, unbendable and rigid, for accommodating drive units with Ø 60 mm clamping throat. Rack and pinion force transmission with ergonomically designed pressing lever which can be inserted in both sides of the slide. Wide steel rack. Base plate with groove for sealing ring of the vacuum fastening. Vacuum fastening as accessory. Drill column with adjustable clamping head for clamping the drill stand between the ceiling and floor or between two walls. Mobile drill stand for easy transport. Weight 19.5 kg.

With tools, consisting of Allen key size 6, single open ended wrench size SW 19 and SW 30 and fastening kit for masonry and concrete, consisting of 2 M12 splaying anchors, 10 M12 hammer anchors for concrete, setting iron for M12 hammer anchors, cord threaded bar M12 x 65, quick clamping nut, washer, carbide masonry drill Ø 15 mm SDS-plus, in box.



REMS Titan

Supply format

REMS Picus S2/3,5 Basic-Pack. Electric diamond core drilling machine for core drilling in concrete, steel-reinforced concrete, all kinds of masonry, natural stone, asphalt, all kinds of screed, up to Ø 300 mm. For dry and wet drilling with drill stand. Drive machine with drilling crown connecting thread UNC 11/4 male, maintenance-free 2-speed gear with safety slip clutch, universal motor 230 V, 50–60 Hz, 3420 W. Multifunction electronics with soft starting, idle speed limiting, overload protection, blocking protection. Touch switch with lock. Personal protection switch (PRCD). Load speed drilling spindle 320 rpm, 760 rpm. Water supply device with adjustable shut-off valve and quick coupling with water stop and hose connection 1/2". Light loosening ring. Single open-ended wrench size 32. In a carton.

	Art.-No.	
	180012	

Other voltages on request.



Supply format

REMS Picus S2/3,5 Set Titan. REMS Picus SR/3.5 Basic-Pack with REMS Titan drilling stand including fastening kit for masonry and concrete.

	Art.-No.	
	180030	

Other voltages on request.



Accessories

Description

REMS Universal diamond core drilling crowns, inductively soldered, resolderable, see page 234.

REMS universal diamond core drilling crowns LS, laser welded, high temperature-resistant, see page 235.

REMS Pull L / M, dry and wet extractors, see page 240

Additional accessories see page 232–233.



Drill stands

Accessories for REMS Picus S1, REMS Picus S3, REMS Picus SR, REMS Picus S2/3,5 and other makes

Supply format

REMS Simplex 2. Robust, handy drilling stand for core drilling up to Ø 200 mm. Drill column made of rigid, unbendable square precision steel tube \varnothing 50 mm, with extra narrow tolerance, for low-vibration guiding of the slide. Drilling column guided in sturdy stand and double bolted for high rigidity during drilling. Steel section stand. 4 Set screws for levelling unevenness of the floor, for exact standing position. Clamping bracket for holding drive machines with clamping throat Ø 60 mm. Slide guided on all sides by adjustable, pretensioned plastic slide bearings. Precision in-feed drive ensures easy, low-vibration drilling and precise, low-vibration drill thrust. For high thrust pressure and long life of the drilling crowns. Spirit level integrated in the slide for exact alignment of the drill stand. Locking of the slide for simple assembly of the drilling crown and safe transport. Stable clamping bracket, unbendable and rigid, for accommodating drive units with Ø 60 mm clamping throat. Rack and pinion force transmission with ergonomically designed pressing lever which can be inserted in both sides of the slide. Wide steel rack Weight 12 kg.

With tools, consisting of Allen key size 6, single open ended wrench size SW 19 and SW 30 and fastening kit for masonry and concrete, consisting of 2 M12 splaying anchors, 10 M12 hammer anchors for concrete, setting iron for M12 hammer anchors, cord threaded bar M12 x 65, quick clamping nut, washer, carbide masonry drill Ø 15 mm SDS-plus, in box.

For REMS Picus S1, REMS Picus S3, REMS Picus SR and other makes.

	Art.-No.	
	183700	



Supply format

REMS Titan. Robust, highly stable drilling stand for core drilling in steel-reinforced concrete and other materials up to Ø 300 mm. For high demands. Drill column made of rigid, unbendable square precision steel tube \varnothing 50 mm, with extra narrow tolerance, for low-vibration guiding of the slide. Continuously tiltable with degree scale up to 45°, with double support by adjustable, single-part steel girders, for maximum thrust pressure. Highly stable, 3-sided guidance of the drill column in the base plate and triple cross fastening for high rigidity in vertical drilling. 4 Eyebolts for levelling unevenness of the floor, for exact standing position. Drill depth scale. Slide guided on all sides by adjustable, pretensioned plastic slide bearings. Precision in-feed drive ensures easy, low-vibration drilling and precise, low-vibration drill thrust. For high thrust pressure and long life of the drilling crowns. Spirit level integrated in the slide for exact alignment of the drill stand. Locking of the slide for simple assembly of the drilling crown and safe transport. Rigid connection plate made of wear-resistant spheroidal iron. Quick-clamping device for accommodating drive units with a suitable connection plate. Highly stable clamping bracket, unbendable and rigid, for accommodating drive units with Ø 60 mm clamping throat. Rack and pinion force transmission with ergonomically designed pressing lever which can be inserted in both sides of the slide. Wide steel rack. Base plate with groove for sealing ring of the vacuum fastening. Vacuum fastening as accessory. Drill column with adjustable clamping head for clamping the drill stand between the ceiling and floor or between two walls. Mobile drill stand for easy transport Weight 19.5 kg.

With tools, consisting of Allen key size 6, single open ended wrench size SW 19 and SW 30 and fastening kit for masonry and concrete, consisting of 2 M12 splaying anchors, 10 M12 hammer anchors for concrete, setting iron for M12 hammer anchors, cord threaded bar M12 x 65, quick clamping nut, washer, carbide masonry drill Ø 15 mm SDS-plus, in box.

System advantage: For REMS Picus S1, REMS Picus S3, REMS Picus SR, REMS Picus S2/3,5 and other makes. Use spacer set (see below) when using with REMS Picus SR.

	Art.-No.	
	183600	



Description	Art.-No.	
Spacer set , for additional fastening of the REMS Picus SR drive machine to the REMS Titan drilling stand, consisting of spacer and two M 8 x 65 cylinder head screws	183632	



Accessories

For REMS Picus S1, REMS Picus SR, REMS Picus S3, REMS Picus S2/3,5 and other makes

Description	Art.-No.
Water pressure tank for 10 ltr of water, for wet drilling without water connection	182006
Titan drilling template for easy setting of the fastening holes. For REMS Titan drilling stand.	183605
Carbide masonry drills Ø 15 mm SDS-plus for hammer anchors M12	079018
Hammer anchor M12 (pack of 50) , for concrete	079005
Setting iron for hammer anchor M12	182050
Carbide masonry drill Ø 20 mm SDS-plus for splaying anchors M12	079019
Splaying anchor M12 (pack of 10) , for masonry, reusable	079006
Quick clamping set 160 for fastening the drilling stand with anchors, consisting of cord threaded bar 160 mm with M12 x 52 thread, quick clamping nut, washer.	079010
Quick clamping set 500 for fastening the drilling stand without anchor, consisting of cord threaded bar 500 mm, 2 quick clamping nuts, 2 washers	183607
Titan vacuum fastening , consisting of cover plate with nipple for 3/8" screw connection and sealing ring for base plate.	183603
Vacuum pump , for vacuum ≤ -900 mbar (90%), consisting of dry running rotary slide pump, oil-free, performance 6 m ³ /h, condenser motor 230 V, 50–60 Hz, 250 W, splash water-protected, inside suction filter with silencer function and 5 m PVC fabric hose with bayonet coupling.	183670
Laser drilling centre pointer	183604
G ½ drill aid with carbide masonry drill Ø 8 mm	180150
Carbide masonry drill Ø 8 mm for drilling aid	079013
Single open ended wrench size 41 for loosening the universal diamond core drilling crowns	079003
Light loosening ring , for light loosening of the diamond core crown	180015
Drilling crown extension 200 mm	180155
Sharpening stone for diamond core drilling crowns	079012
Spirit level , magnetic, with 3 indicators for setting the stand 3-dimensionally	182009
Suction rotor for dust extraction with G ½ male connecting thread, UNC 1¼ male connecting thread and with connection for REMS Pull and other suitable extractors.	180160
Water suction device , for wet drilling up to Ø 170 mm, consisting of water collection ring with pressure ring, rubber washer Ø 200 mm and universal pressure pad for all REMS drilling stands.	183606
Rubber washer Ø 200 mm (pack of 10) , for water suction device	183675
REMS Pull L / M , dry and wet extractor, certified as extractor and dust extractor for extracting health hazardous dusts in accordance with EN 60335-2-69, see page 240	

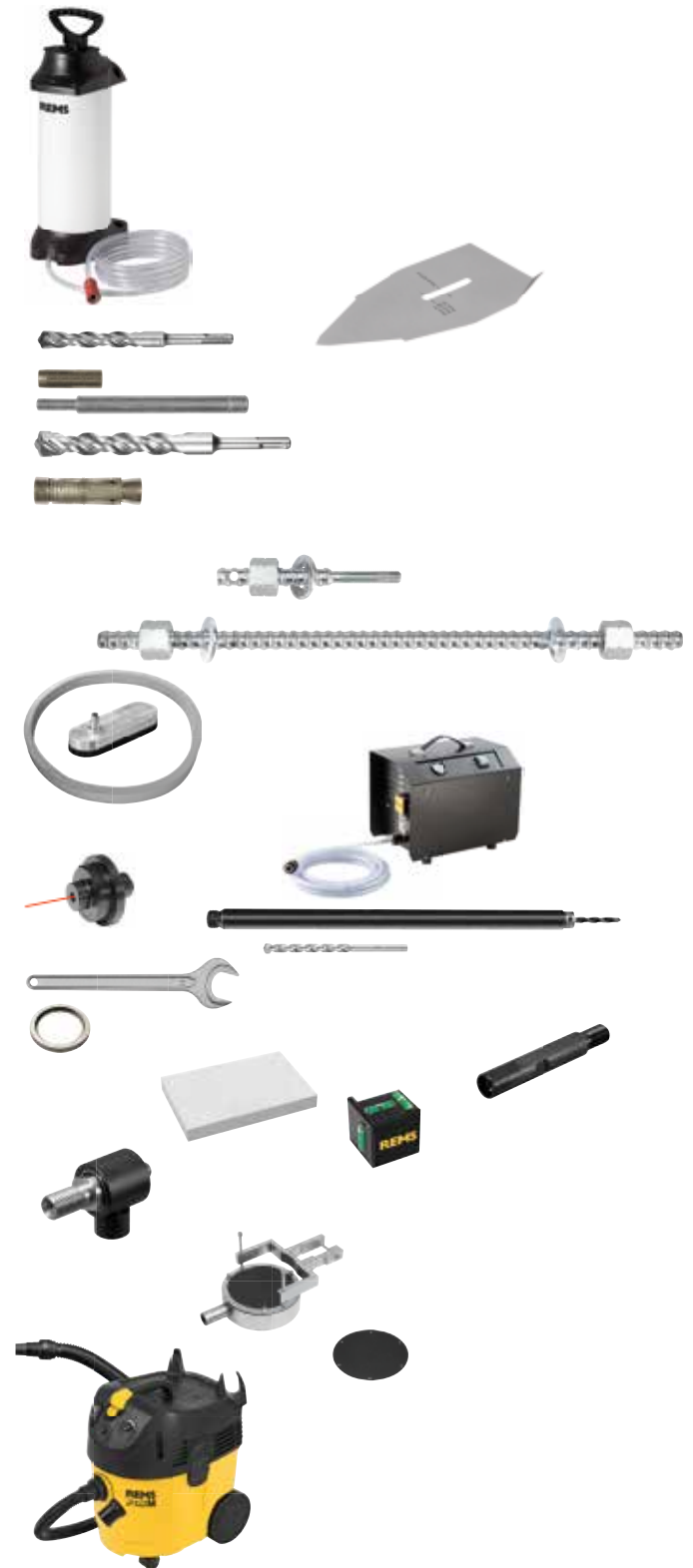

REMS Universal diamond core drilling crowns

For REMS Picus S1, REMS Picus SR, REMS Picus S3, REMS Picus S2/3,5 and other makes

High quality universal diamond core drilling crowns. Inductively soldered. Universally usable for dry and wet drilling, hand held or with drill stand. Ideal for universal applications in steel-reinforced concrete, masonry and many types of material. For installation, metalwork, industry.

Concrete, steel-reinforced concrete, all kinds of masonry, natural stone, asphalt, all kinds of screed and other \varnothing 32–300 mm

REMS Universal diamond core drilling crowns – Inductively soldered. Diamond segments with conical cut for fast, easy and quiet drilling. Versatile for many types of material.

Ideal for plumbers.

Universally usable for many materials, for dry and wet drilling, hand held or with drill stand.

Single connecting thread UNC 1 ¼ female. Drilling depth 420 mm.

Specially developed, high quality diamond segments with high diamond percentage and special bonding, for excellent drilling performance and very long life. Ideal for universal applications in steel-reinforced concrete and masonry.

Diamond segments with conical cut ("roof shape") for fast, easy and quiet drilling. Inductively soldered on fully automatic soldering machines for constant high quality of the soldered connection. Drilling tubes with soldered diamond segments can be resoldered by simple hard soldering.

Light loosening ring, for light loosening of the diamond core crowns, as accessory.

Drive through all REMS Picus drive machines and suitable drive machines of other makes having connecting thread UNC 1 ¼ male. Adapter for using REMS Universal diamond core drilling crowns in drive machines having other connecting threads, as accessory.



German Quality Product



Supply format

REMS Universal diamond core drilling crown. Inductively soldered, resolderable. Universally usable for dry and wet drilling, hand held or with drill stand. For many materials, e.g. concrete, steel-reinforced concrete, all kinds of masonry, natural stone, asphalt, all kinds of screed. Connecting thread UNC 1 ¼ female. Drilling depth 420 mm. In a carton.

\varnothing × drilling depth × connection	Number of segments	Art.-No.
UDKB 32 × 420 × UNC 1 ¼	4	181010
UDKB 42 × 420 × UNC 1 ¼	4	181015
UDKB 52 × 420 × UNC 1 ¼	5	181020
UDKB 62 × 420 × UNC 1 ¼	6	181025
UDKB 72 × 420 × UNC 1 ¼	7	181030
UDKB 82 × 420 × UNC 1 ¼	7	181035
UDKB 92 × 420 × UNC 1 ¼	8	181040
UDKB 102 × 420 × UNC 1 ¼	8	181045
UDKB 112 × 420 × UNC 1 ¼	9	181050
UDKB 125 × 420 × UNC 1 ¼	10	181057
UDKB 132 × 420 × UNC 1 ¼	11	181060
UDKB 152 × 420 × UNC 1 ¼	12	181065
UDKB 162 × 420 × UNC 1 ¼	12	181070
UDKB 182 × 420 × UNC 1 ¼	12	181075
UDKB 200 × 420 × UNC 1 ¼	12	181080
UDKB 225 × 420 × UNC 1 ¼	13	181085
UDKB 250 × 420 × UNC 1 ¼	14	181090
UDKB 300 × 420 × UNC 1 ¼	22	181095



Accessories

Description	Art.-No.
Light loosening ring, for light loosening of the diamond core crown	180015
Drilling crown extension 200 mm	180155
Adapter UNC 1 ¼ male – G ½ male	180052
Adapter UNC 1 ¼ male – G ½ female	180056
Adapter UNC 1 ¼ male – Hilti BI	180053
Adapter UNC 1 ¼ male – Hilti BU	180054
Adapter UNC 1 ¼ male – Würth	180055
Sharpening stone for diamond core drilling crowns	079012
Single open ended wrench size 41 for UDKB	079003

Additional adapters for using REMS Universal diamond core drilling crowns LS in drive machines of other makes, on request.



REMS Universal diamond core drilling crowns LS

For REMS Picus S1, REMS Picus SR, REMS Picus S3, REMS Picus S2/3,5 and other makes

High quality universal diamond core drilling crowns. Laser welded. Universally usable for dry and wet drilling, hand held or with drill stand. Ideal for universal applications in steel-reinforced concrete, masonry and many types of material. For installation, metalwork, industry.

Concrete, steel-reinforced concrete, all kinds of masonry, natural stone, asphalt, all kinds of screed and other \varnothing 32–200 mm

REMS universal diamond core drilling crowns LS – laser welded. Diamond segments with conical cut for fast, easy and quiet drilling. Versatile for many types of material.

Ideal for plumbers.

Universally usable for many materials, for dry and wet drilling, hand held or with drill stand.

Single connecting thread UNC 1¼ female. Drilling depth 420 mm.

Specially developed, high quality diamond segments with high diamond percentage and special bonding, for excellent drilling performance and very long life. Ideal for universal applications in steel-reinforced concrete and masonry.

Diamond segments with conical cut ("roof shape") for fast, easy and quiet drilling. Inductively soldered on fully automatic soldering machines for constant high quality of the soldered connection. Drilling tubes with soldered diamond segments can be resoldered by simple hard soldering.

Light loosening ring, for light loosening of the diamond core crowns, as accessory.

Drive through all REMS Picus drive machines and suitable drive machines of other makes having connecting thread UNC 1¼ male. Adapter for using REMS Universal diamond core drilling crowns LS in drive machines having other connecting threads, as accessory.



Supply format

REMS Universal diamond core drilling crown. Laser welded! High temperature-resistant! Universally usable for dry and wet drilling, hand held or with drill stand. For many materials, e.g. concrete, steel-reinforced concrete, all kinds of masonry, natural stone, asphalt, all kinds of screed. Connecting thread UNC 1¼ female.

Drilling depth 420 mm. In a carton.

\varnothing × drilling depth × connection	Number of segments	Art.-No.
UDKB LS 32 × 420 × UNC 1¼	1	181410
UDKB LS 42 × 420 × UNC 1¼	4	181415
UDKB LS 52 × 420 × UNC 1¼	5	181420
UDKB LS 62 × 420 × UNC 1¼	6	181425
UDKB LS 72 × 420 × UNC 1¼	6	181430
UDKB LS 82 × 420 × UNC 1¼	7	181435
UDKB LS 92 × 420 × UNC 1¼	8	181440
UDKB LS 102 × 420 × UNC 1¼	9	181445
UDKB LS 112 × 420 × UNC 1¼	9	181450
UDKB LS 125 × 420 × UNC 1¼	10	181457
UDKB LS 132 × 420 × UNC 1¼	10	181460
UDKB LS 152 × 420 × UNC 1¼	11	181465
UDKB LS 162 × 420 × UNC 1¼	12	181470
UDKB LS 182 × 420 × UNC 1¼	13	181475
UDKB LS 200 × 420 × UNC 1¼	14	181480



Accessories

Description	Art.-No.
Light loosening ring, for light loosening of the diamond core crown	180015
Drilling crown extension 200 mm	180155
Adapter UNC 1¼ male – G ½ male	180052
Adapter UNC 1¼ male – G ½ female	180056
Adapter UNC 1¼ male – Hilti BI	180053
Adapter UNC 1¼ male – Hilti BU	180054
Adapter UNC 1¼ male – Würth	180055
Sharpening stone for diamond core drilling crowns	079012
Single open ended wrench size 41 for UDKB	079003

Additional adapters for using REMS Universal diamond core drilling crowns LS in drive machines of other makes, on request.



Diamond tipped dry drilling crowns for fast, clean drilling in all kinds of tiles. Ideal for assembly and renovation.

Ceramic, fine clay, granite, marble etc.

REMS tile drilling – for dry drilling.

Can be used universally for dry drilling without hammering in ceramic, fine clay, granite, marble and other materials. No cracking of the tiles.

No water necessary.

Special wax filling inside the dry drilling crown as a cooling lubricant, becomes liquid when heated and cools the dry drilling crown.

Simple, free-hand starting by drill aid with vacuum fastening. Hexagon connection for 1/4" bit holders.

Drive by cordless REMS Helix power drill (see page 91) and other electric drills/screwdrivers (speed ≥ 1,000 rpm).



Supply format

REMS tile drilling Set 6-8-10. Diamond-studded dry drilling crowns with special wax filling. For ceramic, fine clay, granite, marble and other materials. Tile drilling Ø 6, 8, 10 mm, drill aid with vacuum fastening. In blister pack.

	Art.-No.
	181700



Accessories

Description	Art.-No.
REMS tile drilling Ø 5 mm	181710
REMS tile drilling Ø 6 mm	181711
REMS tile drilling Ø 8 mm	181712
REMS tile drilling Ø 10 mm	181713
REMS tile drilling Ø 12 mm	181714
REMS tile drilling Ø 14 mm	181715

REMS Helix, cordless drill/screwdriver, see page 91





Compact, handy power tool for dry chasing and cutting, e.g. of concrete, steel-reinforced concrete, all kinds of masonry, natural stone, all kinds of screed. For trade and industry.

REMS Krokodil 125

Chase depth	≤ 38 mm
Chase width	≤ 43 mm
Number of diamond cutting discs	1–2

REMS Krokodil 180 SR

Chase depth	≤ 63 mm
Chase width	≤ 62 mm
Number of diamond cutting discs	1–3

REMS Universal diamond cutting discs, also for suitable drive machines of other makes, see page 239.

REMS Krokodil – chasing instead of chiselling. Full contact support plate. Multi-function electronics.

Universal use

Universal drive machine for dry chasing and cutting. Ideal for producing chases/grooves for laying pipes and electric cables in heating, sanitary and electrical installation, air-conditioning and cooling technology.

Design

REMS Krokodil 125: Compact, handy drive machine, only 5.8 kg. Robust, suitable for building site conditions. Fast, easy working, e.g. chases in masonry 500 mm long, 38 mm deep, only 25 s. Full contact support plate during the entire chasing/cutting process for guided plunge-in of the diamond cutting discs, dust-free, safe working and easy, even feed. Practical switch grip, adjustable in two positions, parallel or transversely to the machine axis and swivel handle, for optimum working position and ergonomic work. Locking of the drive shaft for easy changing of the universal diamond cutting discs. Continuously adjustable depth stop. Suction nozzle for connecting a dust extractor integrated into the housing.

REMS Krokodil 180 SR: Compact, handy drive machine, only 7.2 kg. Robust, suitable for building site conditions. Fast, easy working, e.g. chases in masonry 500 mm long, 63 mm deep, only 34 s. Full contact support plate during the entire chasing/cutting process for guided plunge-in of the diamond cutting discs, dust-free, safe working and easy, even feed. Practical switch handle with triple force-transmitting leverage for easy plunge-in and effective feeding. Swivel handle, for optimum working position and ergonomic work. Locking of the drive shaft for easy changing of the universal diamond cutting discs. Continuously adjustable depth stop. Suction nozzle for connecting a dust extractor integrated into the housing.

Drive

REMS Krokodil 125: Robust, powerful universal motor, 1,850 W. Load speed of the drive shaft of the cutting discs 5,000 rpm. Strong, maintenance-free gear with safety slip clutch. Connecting cable 2.3 m. Safety switch with lock.

REMS Krokodil 180 SR: Robust, powerful universal motor, 2,000 W. Load speed of the drive shaft of the cutting discs 5,000 rpm. Overheating protection by temperature monitoring of the motor's field winding with a PTC resistor (Positive Temperature Coefficient). Strong, maintenance-free gear. Connecting cable 5.7 m. Safety switch with lock. Restart protection in case of mains failure.

Speed Regulation

The electronic tachometer speed control (REMS Krokodil 180 SR) used for regulation keeps the speed constant, also under load. Advantage: The chasing and cutting speed (load speed) is maintained during the entire chasing and cutting process for a high chasing and cutting performance.

Multi-function electronics

Multifunction electronics with start-up current limiting for soft starting for delicate engagement of the diamond cutting discs, automatic idle speed limiting for noise reduction and preservation of the motor, overload and blocking protection for motor and gear.

Universal diamond cutting discs

Universally usable for straight chasing and cutting. Specially developed, high quality diamond segments with high diamond content and special bonding for excellent chasing/drilling performance and very long life. Optionally REMS Universal diamond cutting discs Eco, sintered, REMS Universal diamond cutting discs LS Turbo, laser-welded, high temperature-resistant, for fast cuts and cuts in hard materials or REMS Universal diamond cutting discs LS H-P, high-performance, laser-welded, high temperature-resistant, for fast cuts and cuts in very hard materials, with long life, (page 239). Metal body in accordance with EN 13236. Mounting bore \varnothing 22.23 mm

Dust extraction in accordance with EN 60335-2-69

When working with mineral building materials, e.g. concrete, steel-reinforced concrete, masonry and screed, a high degree of mineral dust containing quartz is produced which is harmful to the health. Inhalation of quartz fine dust is harmful to the health. EN 60335-2-69 prescribes the use of at least one safety extractor of dust class M for the extraction of health hazardous dusts with an exposure limit/work place limit of $> 0.1 \text{ mg/m}^3$. Observe the national regulations. REMS Pull M, wet and dry dust extractor, certified for extracting health hazardous dusts of dust class M, see page 240.



Supply format

REMS Krokodil 125 Basic-Pack. Electric diamond chasing and cutting grinder for chasing and cutting concrete, steel-reinforced concrete, all kinds of masonry, natural stone, all kinds of screed. Chase depth 38 mm, continuously adjustable. Chase width ≤ 43 mm, stepped with spacer discs 3, 6, 10, 20 mm. Drive machine with drive shaft $\varnothing 22.2$ mm, for 1 or 2 diamond cutting discs in accordance with EN 13236, $\varnothing \leq 125$ mm, with maintenance-free gear with safety slip clutch, 230 V, 50–60 Hz, 1,850 W universal motor. Multifunction electronics with soft start, idling speed limiting, overload protection. Connecting cable 2.3m. Safety switch with lock. Load speed 5,000 rpm. Suction nozzle for connecting an extractor/dust extractor. Pin wrench size 13. In sturdy carrying case.

	Art.-No.
	185010

Other voltages on request.



Supply format

REMS Krokodil 180 SR Basic-Pack. Electric diamond chasing and cutting grinder with speed regulation. For chasing and cutting concrete, steel-reinforced concrete, all kinds of masonry, natural stone, all kinds of screed. Chase depth 63 mm, continuously adjustable. Chase width ≤ 62 mm, stepped with spacer discs 3, 6, 10, 20 mm. Drive machine with drive shaft $\varnothing 22.2$ mm, for 1, 2 or 3 diamond cutting discs in accordance with EN 13236, $\varnothing \leq 180$ mm, with maintenance-free gear, 230 V, 50–60 Hz, 2,000 W universal motor. Multifunction electronics with soft start, idling speed limiting, overload protection, overheating protection. Restart protection in case of mains failure. Connecting cable 5.7m. Safety switch with lock. Load speed 5,000 rpm. Suction nozzle for connecting an extractor/dust extractor. Pin wrench size 13. In sturdy steel case.

	Art.-No.
	185011

Other voltages on request.



Accessories

Description	Art.-No.
REMS Krokodil 125 drive unit	185000
REMS Krokodil 180 SR drive unit	185001
REMS Universal diamond cutting disc Eco $\varnothing 125$ mm, sintered, with metal body in accordance with EN 13236	185020
REMS Universal diamond cutting disc LS-Turbo $\varnothing 125$ mm, laser-welded, high temperature-resistant, for fast cuts and cuts in very hard materials, with metal body in accordance with EN 13236	185021
REMS Universal diamond cutting disc LS H-P $\varnothing 125$ mm, high-performance, laser-welded, high temperature-resistant, for fast cuts and cuts in very hard materials, long life, with metal body in accordance with EN 13236.	185022
REMS Universal diamond cutting disc Eco $\varnothing 180$ mm, sintered, with metal body in accordance with EN 13236	185025
REMS Universal diamond cutting disc LS-Turbo $\varnothing 180$ mm, laser-welded, high temperature-resistant, for fast cuts and cuts in very hard materials, with metal body in accordance with EN 13236	185026
REMS Universal diamond cutting disc LS H-P $\varnothing 180$ mm, high-performance, laser-welded, high temperature-resistant, for fast cuts and cuts in very hard materials, long life, with metal body in accordance with EN 13236.	185027
Chasing chisel for removing the ridge after chasing	185024
Case with inlay for REMS Krokodil 125	185054
Steel case	185058

REMS Pull L / M, dry and wet extractors, see page 240



REMS Pull L / M

Dry and wet extractor

Powerful, electric dry and wet extractor with automatic filter cleaning. For commercial use in trade and industry.

For extraction of dusts, dirt and liquids.

Ideal for dust extracting when chasing, cutting, drilling, core drilling and grinding.

Certified as extractor and dust extractor for extracting health hazardous dusts.

Ideal for extracting drilling sludge during core drilling.

REMS Pull L

Dust class in accordance with EN 60335-2-69	L
Exposure limit/work place limit	> 1 mg/m ³
Penetration level	≤ 1 %

REMS Pull M

Dust class in accordance with EN 60335-2-69	M
Exposure limit/work place limit	> 0.1 mg/m ³
Penetration level	≤ 0.1 %

REMS Pull – for dry and wet suction.

Constantly high suction performance

by permanent automatic filter cleaning.

Certified for extracting health hazardous dusts.

Universal use

Powerful, handy extractor for dry and wet suction. For extraction of dusts, dirt and liquids. Excellently suited for dust extracting when chasing, cutting, drilling, core drilling and grinding. Certified as an extractor and dust extractor for extracting health hazardous dusts of dust class L or M in accordance with EN 60335-2-69. For commercial use in trade and industry.

Design

Compact, handy design. REMS Pull L only 12.5 kg, REMS Pull M only 12.7 kg. Light and manoeuvrable by rubber wheels and steerable castors, lockable by castor with brake. Large tank capacity 35 l, filling volume for liquids 19 l. On/off switch and switch for automatic filter cleaning with integrated green LED to display operation stand-by of the automatic filter cleaning. Adapter for connecting a power tool to the extractor, individually adaptable to the suction nozzle of the used power tool. Flexible suction hose 2.5 m, practical suction hose extension 2.5 m, ergonomically angled handle, 2 insertable, chrome-plated metal suction tubes 0.5 m for adapting the suction pipe length. Wide wet/dry surface attachment 300 mm with rubber-coated castors, optionally brush strips for extracting dusts and dirt or rubber lips for extracting liquids. Joint attachment for confined spaces. Large working radius by long 7.5 m connecting lead. Holders for connecting lead, suction hose, metal suction tubes and accessories integrated into the extractor. Practical handle for easy transport.

REMS Pull M is suitable and certified for the extraction of health hazardous dusts of dust class M in accordance with EN 60335-2-69, with electronic volume flow monitoring, selector switch for adapting the suction power to different suction hose diameters (21, 27, 35 mm) and stopper for the suction hose connection nozzle.

Permanent automatic filter cleaning

REMS Pull L and REMS Pull M with innovative, patented, automatic filter cleaning, prevents clogging of the filter with dust, especially effective in fine dust applications. The flat folded filter is cleaned automatically every 15 s by targeted, powerful shots of air. The suction force remains constantly high during cleaning. Patented flat folded filter system.

Drive

Robust, powerful bypass motor, 1,200 W, with high-power turbine. High suction power, continuously adjustable up to an air rate ≤ 61 l/s, for optimum adaptation to the suction surface and the extracted product.

Automatic switch-off

Filling level limiting with automatic switch off on reaching the maximum liquid filling level when extracting electrically conductive liquids.

Automatic power tool on/off

Appliance socket for power tools up to 2,200 W, with electronic automatic on/off integrated into the extractor. The extractor switches on/off automatically when the power tool is switched on/off. For convenient working.

Anti-static system (REMS Pull M)

Static charge is dissipated to the earthed upper section of the extractor by electrically conductive metal suction pipes, electrically conductive handle E, electrically conductive suction hose E, electrically conductive suction hose extension E and electrically conductive suction hose connection nozzle.

Dust extraction in accordance with EN 60335-2-69

When working with mineral building materials, e.g. concrete, steel-reinforced concrete, masonry and screed, a high degree of mineral dust containing quartz is produced which is harmful to the health. Inhalation of quartz fine dust is harmful to the health. EN 60335-2-69 prescribes the use of at least one safety extractor of dust class M for the extraction of health hazardous dusts with an exposure limit/work place limit of > 0.1 mg/m³. Observe the national regulations.



Certified extractor and dust extractor for extracting health hazardous dusts in accordance with EN 60335-2-69.



Extraction of health hazardous dusts when chasing and cutting:
REMS Pull M Set



Extraction of health hazardous dusts when dry drilling:
REMS Pull M Set D

Water extraction

PES flat folded filter required for extraction of water. Use wet filter bag or polythene bag if necessary. Wet filter bags separate the water from the sucked up solids when extracting dirty water. Polythene bags simplify disposal of the dirt and prevent dirt from collecting in the tank.

Supply format

REMS Pull Set. Electric dry and wet extractor for commercial use. For extraction of dusts, dirt and liquids. Ideal for dust extracting when chasing, cutting, drilling, core drilling and grinding. Certified extractor and dust extractor for extracting health hazardous dusts in accordance with EN 60335-2-69¹⁾. Bypass motor 230 V, 50–60 Hz, 1,200 W. On/off switch and switch for automatic filter cleaning with integrated green LED. Suction power switch for continuous adjustment of the air rate ≤ 61 l/s. Filling level limiting with automatic switch-off. Automatic filter cleaning. Appliance socket for power tools up to 2,200 W, with electronic automatic on/off. Large tank capacity 35 l, filling volume for liquids 19 l. Mobile, 2 wheels, castor/castor with brake. Connecting cable 7.5 m. 1 paper filter bag, 1 flat folded paper filter. 2 metal suction pipes 0.5 m each, handle, suction hose 2.5 m, suction hose extension 2.5 m. Wet/dry surface attachment 300 mm with rollers, brush strips, rubber lips. Joint attachment. Suction hose/power tool adapter. Integrated holders for connecting cable, suction hose and accessories. In a box.

Description	Version	Art.-No.	
Pull L Set	Dust class L. Exposure limit/work place limit > 1 mg/m ³ , penetration level ≤ 1 %.	185500	
Pull L Set W	REMS Pull L Set including water-resistant flat pleated filter PES and water extraction device. Ideal for extraction of drilling sludge when wet drilling with REMS drill stands.	185503	
Pull M Set	Dust class M. Exposure limit/work place limit > 0.1 mg/m ³ , penetration level ≤ 0.1 %. Electronic volume flow monitor with acoustic signal. Selector switch for suction hose diameter. Stopper for the suction hose connection nozzle. Anti-static system with electrically conductive metal suction pipes, handle, suction hose, suction hose extension, suction hose connection nozzle.	185501	
Pull M Set D	REMS Pull M Set including suction rotor for dust extraction. Ideal for extracting health hazardous dusts when dry drilling with REMS Picus S1, Picus SR, Picus S3 etc.	185504	



Extraction of drilling sludge when wet drilling with REMS drill stands:
REMS Pull L Set W

Extraction of health hazardous dusts when chasing and cutting:
REMS Pull L Set



REMS Pull L Set



Safety extractor of dust class L



Safety extractor of dust class M



REMS Pull M Set

Accessories

Description	Art.-No.	
Paper filter bag (pack of 5) , cellulose, 2-ply, for wet extraction, M-certified, for normal dirt, fine dusts	185510	
Felt filter bag (pack of 5) , polyester felt, 3-ply, tear-proof, for wet and dry extraction, M-certified, for normal dirt, fine dusts, abrasive dusts, wet dirt	185511	
Wet filter bag (pack of 5) , paper-polyester woven felt, tear-proof, for wet and dry extraction, for abrasive dusts, wet dirt, liquids	185512	
Polythene bag (pack of 10) , for wet and dry extraction of non-health hazardous dusts, for normal dirt, fine dusts, abrasive dusts, wet dirt, liquids. Prevents soiling of the tank.	185513	
Flat, folded filter paper , cellulose, nano-coated, 1 piece, for dry extraction, M-certified	185514	
Flat folded filter PES , polyester, nano-coated, 1 piece, water-resistant, non-rotting, washable with water. For wet and dry extraction, M-certified	185515	
Adapter suction hose/power tool	185527	



¹⁾ Observe the national regulations for the collection and disposal of health hazardous dusts.

Index

Symbols	
4" Automatic die head	39
A	
Akku-Cat ANC VE	61
Akku-Curvo	114, 115
Akku-Ex-Press Cu ACC	177
Akku-Ex-Press P	180
Akku-Ex-Press P ACC	179
Akku-Ex-Press Q&E ACC	182
Akku-Nano	75
Akku-Press	142
Akku-Press ACC	143
Akku-ROS P 40	80
Amigo	25
Amigo 2	26
Amigo 2 Compact	27
Amigo E	24
Aquila 3B	92
Aquila WB	92
Assembling	89
Attachment heads for button dies / intermediate rings / guide bushings	29
Axial Press Jointing	165
Ax-Press 25 / 25 L ACC	166, 167
Ax-Press 30	172
Ax-Press 40	173
Ax-Press HK / H	168
B	
Battery LED Lamp	95
Bending	107
Bending formers and back formers	117
Blitz	192
Brazing solder B-Cu94P-710/890, EN 1044	193
Butt welding machine	216, 217, 218, 219
Butt welding units	220
C	
Cable shear	163
CamScope / CamScope S	202, 203
CamScope Wi-Fi	200, 201
CamSys	204, 205
Cat ANC VE	57
Catch S	90
Catch W	90
Cento	76, 77
Chain pipe vice	92
Chain pipe vice for workbench	92
Chamfering	67
Chasers	42
Chasers and Holders	42
Circular pipe sawing machine	64
CleanH	103
Cleaning	97
Cleaning and preservation unit for heating systems	103
Cleaning pads	190
CleanM	103
Cobra 22/32	208, 209, 210, 211
Collum RG	49
Compression heads	169, 170
Confirmation of suitability	161
Contact 2000	191
Cordless axial press	172, 173
Cordless axial press with automatic return	166, 167
Cordless pipe cutter	75
Cordless pipe expander with automatic return	177, 179, 182
Cordless pipe expander with switch-off signal	180
Cordless pipe shears	80
Cordless power drill/screwdriver	91
Cordless radial press with automatic circuit control	122, 123, 143
Cordless radial press with switch-off signal	142
Cordless tube bender	114, 115
Cordless universal reciprocating saw	61
Cropping tongs	163
Cropping tongs Mini	137
Curvo	112, 113
Curvo 50	111
Cut 110 Cu-INOX	84
Cut 110 P	83
Cutter wheels	72
Cutting	67
Cu-Vlies	190
D	
Deburring	67
Diamond chasing and cutting machine	223
Diamond chasing and cutting machines	238, 239
Diamond core drilling	223
Dies	28, 38
Disinfecting	97
Disinfection unit for drinking water installations	103
Drain cleaner for manual and electric operation	206
Drill stands	232
Dry and wet extractor	240, 241
DueCento	78, 79
E	
Eco-Press	138
Electric diamond core drilling machine	224, 225, 226, 227, 230, 231
Electric diamond core drilling machine with speed regulation	228, 229
Electric die stock with quick-change die heads	24, 25, 26, 27
Electric drain cleaning machine	207
Electric filling and flushing unit	104, 105
Electric pipe and drain cleaning machines	208, 209
Electric pipe and tube bender	111, 112, 113
Electric pipe and tubing cutter	74
Electric pipe freezing unit	197
Electric pressure testing pump	99
Electric radial press	139
Electric reciprocating pipe saws	58, 59
Electric sleeve welding unit	214
Electric soldering pliers	190
Electric soldering unit	191
Electric tube expander	186, 187
Electric tube extractor	185, 187
Electro-hydraulic pipe expander with automatic return	183
Electro-hydraulic radial press with automatic retraction	141
Electro-hydraulic radial press with switch-off signal	140
Electronic camera inspection system	204, 205
Electronic flushing and pressure testing unit with compressor	100, 101, 102, 103
EMSG 160	214
Endoscope camera with radio signal transmission	202, 203
Endoscope camera with Wi-Fi radio standard	200, 201
E-Push 2	99
Eskimo	196
Eva	22
Expander heads P	181
Expanding	175
Ex-Press Cu	176
Ex-Press H	178
Ex-Press P	178
Extracting	175
F	
Filling	97
Flushing	97
Folding work bench	64, 65, 74, 75
Folding work benches	93
Freezing	195
Frigo 2	197
H	
Hand and standing lamp	95
Hand die stock with quick-change die heads	22
Hand pressure testing pump	98
Hand tube bender	116
Hand tube expander	176, 178
Hand tube extractor	184
Helix VE	91
Herkules	94
Hold-Harmless and Indemnification Agreement	162
Hot Dog 2	190
Hurrican	185
Hurrican H	184
Hydraulic pipe bender	108, 109
I	
Inner pipe deburrer	85
J	
Jumbo	93

Index

K

Krokodil 125/180 SR..... 238, 239

L

Lot Cu 3..... 193
Lot P6..... 193

M

Machine cleaner..... 103
Macho..... 192
Magnum RG..... 50, 51
Magnum (up to 2")..... 32, 33
Magnum (up to 3")..... 34, 35
Magnum (up to 4")..... 36, 37
Manual axial press..... 168
Manual radial press..... 138
Material supports..... 39, 94
Mini-Cobra..... 206
Mini-Cobra S..... 207
Mini-Press 22V ACC..... 123
Mini-Press ACC..... 122
MSG..... 215
Multi-Push..... 100, 101, 102, 103

N

Nano..... 74
Nippelfix..... 46
Nippelspanner..... 46
NoCor..... 103

O

One-hand axial press..... 168
One-hand pipe expander..... 178
Outer-inner pipe deburrer..... 86, 87
Outer-inner tube deburrer..... 85

P

Paste Cu 3..... 193
Peroxi Color..... 103
Picus S1..... 224, 225
Picus S2/3,5..... 230, 231
Picus S3..... 226, 227
Picus SR..... 228, 229
Pipe and Drain cleaning..... 199
Pipe and Drain inspection..... 199
Pipe chamfering tools..... 84
Pipe cutters..... 68
Pipe cutting and pipe chamfering tool..... 83
Pipe cutting machine..... 76, 77, 78
Pipe cutting tool..... 84
Pipe freezer..... 196
Pipe shears..... 81, 82
Plastic Pipe Welding..... 213
Pneumatic reciprocating pipe saw..... 60
Portable pipe workstation with chain pipe vice..... 92
Power-Ex-Press Q & E ACC..... 183
Power-Press..... 140
Power-Press ACC..... 141
Power-Press SE..... 139
Preserving..... 97
Pressing rings..... 124, 125, 126, 127, 128, 129, 130, 131, 132, 133, 134, 135, 136, 144, 145, 146, 147, 148, 149, 150, 151, 152, 153, 154, 155, 156, 157, 158, 159, 160
Pressing tongs..... 144, 145, 146, 147, 148, 149, 150, 151, 152, 153, 154, 155, 156, 157, 158, 159, 160
Pressing tongs Mini..... 124, 125, 126, 127, 128, 129, 130, 131, 132, 133, 134, 135, 136
Pull L / M..... 240, 241
Pull-Push..... 206
Puma VE..... 56
Push..... 98
Python..... 108, 109

Q

Quick-change die heads..... 28
Quick-change die heads S..... 23

R

Radial Press Jointing..... 119
RAG..... 84
RAS Cu..... 70
RAS Cu-INOX..... 68, 69
RAS P..... 71
RAS St..... 68
Reciprocating saws..... 54, 55
REG 3-35..... 85
REG 8-35..... 86
REG 10-42..... 86
REG 10-54..... 87
REG 10-54 E..... 87
REG St ¼-2"..... 85
REG Universal..... 85
Roll Grooving..... 21
Roll grooving attachment..... 48
Roll grooving machine..... 49, 50, 51
ROS..... 81, 82

S

Sanitol..... 47
Saw blades..... 63
Sawing..... 53
Single-hand tube bender..... 110
Sinus..... 116
Sleeve welding units..... 215
Soft solder paste of solder powder S-Sn97Cu3 according to EN 29453 and flux 3.1.1.C, EN 29454-1..... 193
Soft solder S-Sn97Cu3, EN 29453..... 193
Solar-Push..... 104, 105
Soldering..... 189
Special saw blades..... 62
Spezial..... 47
SSG..... 220
SSM 160KS..... 217
SSM 160RS..... 216
SSM 250KS..... 218
SSM 315RF..... 219
Suction and pressure cleaning device..... 206
Swedish pattern wrench 'S'..... 90
Swing..... 110

T

Testing..... 97
Thread-cutting oil..... 47
Threading..... 21
Threading attachment..... 39
Threading machine..... 30, 31, 32, 33, 34, 35, 36, 37, 40, 41, 44, 45
Thread tables..... 43
Tiger ANC pneumatic..... 60
Tiger ANC/VE/SR..... 58, 59
Tile drilling..... 236
Tornado..... 30, 31
Tubing cutters..... 68, 69, 70, 71
Turbo Cu-INOX..... 64
Turbo K..... 65
Turbo soldering torch acetylene..... 192
Turbo soldering torch propane..... 192
Twist..... 186
Twist/Hurrican..... 187

U

Unimat 75..... 40, 41
Unimat 77..... 44, 45
Universal circular metal sawing machine with automatic cooling lubricant unit..... 65
Universal deburrer..... 85
Universal diamond core drilling crowns..... 234
Universal diamond core drilling crowns LS..... 235
Universal electric reciprocating saw..... 56, 57
Universal saw blades..... 62

V

V-Jet H..... 103
V-Jet TW..... 103

W

Water pump pliers..... 90
Wet and dry suction..... 223

List of articles

Art.-No.	RG	VE	Page	Art.-No.	RG	VE	Page	Art.-No.	RG	VE	Page	Art.-No.	RG	VE	Page
043054	Z		102, 105	130209	Z		196	150946	Z		181	171275	Z		211
045159	Z		102	130410	Z		196	150947	Z		181	171280	Z		211
047069	Z		102	130415	Z		196	150950	Z		181	171290	Z		211
074021	Z		184	130430	Z		196	150952	Z		181	171291	Z		211
074041	Z		184	130450	Z		196	150957	Z		181	171305	Z		211
076117	Z		184	130455	Z		196	150958	Z		181	171306	Z		211
079003	Z		233-235	130460	Z		196	151000	E		185	171340	Z		211
079005	Z		233	130465	Z		196	151002	E		185	171341	Z		211
079006	Z		233	130470	Z		196	151003	H		184	172000	Z		209
079010	Z		233	130475	Z		196	151004	H		184	172010	M		209
079012	Z		233-235	130480	Z		196	151005	H		184	172011	M		209
079013	Z		233	130485	Z		196	151010	E		185	172012	M		209
079018	Z		233	130490	Z		196	151105	Z		184-185, 187	172050	Z		210
079019	Z		233	130495	Z		196	151110	Z		184-185, 187	172051	Z		210
090015	Z		103	131011	M		197	151120	Z		184-185, 187	172150	Z		210
091072	Z		103	131110	Z		197	151125	Z		184-185, 187	172151	Z		210
091073	Z		103	131156	Z		197	151130	Z		184-185, 187	172154	Z		210
110000	Z		46	131157	Z		197	151140	Z		184-185, 187	172200	Z		210
110100	Z		46	131158	Z		197	151145	Z		184-185, 187	172201	Z		210
110200	Z		46	131160	Z		197	151150	Z		184-185, 187	172203	Z		210
110300	Z		46	140100	V	4	47	151155	Z		184-185, 187	172205	Z		210
110400	Z		46	140101	V		47	151160	Z		184-185, 187	172210	Z		210
110500	Z		46	140103	V		47	151165	Z		184-185, 187	172250	Z		211
110600	Z		46	140105	V	12	47	151170	Z		184-185, 187	172265	Z		211
110620	Z		46	140106	V	15	47	151175	Z		184-185, 187	172270	Z		211
110621	Z		46	140110	V	4	47	151200	Z		184-185, 187	172275	Z		211
111000	Z		46	140113	V		47	151210	Z		184-185, 187	172280	Z		211
111100	Z		46	140115	V	12	47	151230	Z		184-185, 187	172281	Z		211
111200	Z		46	140116	V	15	47	151240	Z		184-187	172290	Z		211
111300	Z		46	140119	V	15	103	151401	Z		184-187	172291	Z		211
111400	Z		46	140120	V	15	111, 113, 115-116	151600	Z		185-187	172293	Z		211
111500	Z		46	150000	H		176	151615	Z		214	172305	Z		211
111620	Z		46	150005	H		176	151618	Z		184	172310	Z		211
111621	Z		46	150006	H		176	152106	Z		192	172340	Z		211
111700	Z		46	150007	H		176	152109	Z		192	172341	Z		211
111800	Z		46	150008	H		176	153020	H		110	172610	Z		211
111900	Z		46	150010	H		176	153021	H		110	172611	Z		211
113000	H		68	150017	H		176	153022	H		110	172612	Z		211
113100	H		68	150018	H		176	153023	H		110	174000	Z		209
113200	H	10	68	150019	H		176	153025	H		110	174010	M		209
113210	V	10	69, 72, 83-84	150020	H		176	153026	H		110	174011	M		209
113213	V	10	69, 72	150021	H		178	153027	H		110	174012	M		209
113220	V	10	72	150022	H		178	153028	H		110	174050	Z		210
113225	V	10	70, 72	150023	H		178	153029	H		110	174101	Z		210
113240	H	10	68	150025	H		178	153100	Z		110	174150	Z		210
113241	H	10	68	150026	H		178	153115	Z		110	174154	Z		210
113300	H	10	69	150027	H		178	153125	Z		110	174200	Z		210
113320	H	8	70	150028	H		178	153140	Z		110	174201	Z		210
113330	H	8	69	150029	H		178	153155	Z		110	174203	Z		210
113340	H	10	70	150033	H		178	153160	Z		110	174205	Z		210
113350	H	10	69	150100	Z		176	153170	Z		110	174210	Z		210
113351	H	10	69	150105	Z		176	153175	Z		110	174250	Z		211
113360	Z		69-70, 85	150110	Z		176	153180	Z		110	174265	Z		211
113370	H		70	150120	Z		176	153185	Z		110	174270	Z		211
113380	H		69	150125	Z		176	153190	Z		110	174275	Z		211
113400	H		69	150130	Z		176	153195	Z		110	174282	Z		211
113401	H		69	150140	Z		176	153200	Z		110	174291	Z		211
113410	H		70	150145	Z		176	153205	Z		110	174293	Z		211
113500	H		69	150150	Z		176	153210	Z		110	174295	Z		211
113810	H		86	150155	Z		176	153265	Z		110	174296	Z		211
113815	Z		86	150160	Z		176	153270	Z		110	174305	Z		211
113825	H	10	86	150165	Z		176	154000	Z		116	174306	Z		211
113830	H	10	87	150170	Z		176	154001	H		116	174310	Z		211
113835	H	10	87	150175	Z		176	154002	H		116	174311	Z		211
113840	Z		77	150180	Z		176	154003	H		116	174340	Z		211
113900	H	10	85	150185	Z		176	154004	H		116	174341	Z		211
113910	H	10	85	150190	Z		176	154010	H		116	175000	Z		205
115000	H		98	150195	Z		176	154160	H		116	175007	M		205
115001	H		98	150205	Z		176	156000	E		186	175008	M		205
115045	Z		98-99, 102	150210	Z		176	156002	E		186	175010	M		205
115110	Z		98-99	150220	Z		176	156004	E		186	175011	Z		205
115140	Z		102	150225	Z		176	156010	E		187	175012	Z		205
115217	Z		105	150230	Z		176	156012	E		187	175016	Z		205
115220	Z		105	150235	Z		176	156014	E		187	175018	Z		205
115221	Z		105	150240	Z		176	156150	Z		186-187	175026	Z		205
115311	M		105	150245	Z		176	156200	Z		186-187	175057	Z		205
115312	M		105	150250	Z		176	156225	Z		186-187	175058	Z		205
115314	Z		105	150500	Z		176	156250	Z		186-187	175102	Z		201, 203
115315	Z		105	150510	Z		178	156300	Z		186-187	175103	Z		201, 203
115319	Z		105	150550	H		178	156350	Z		186-187	175104	Z		201, 203
115323	S		105	150600	Z		176, 178	156375	Z		186-187	175105	Z		201, 203
115324	Z		105	150812	Z		181	156400	Z		186-187	175106	Z		201, 203
115325	Z		105	150814	Z		179	156425	Z		186-187	175110	E		203
115326	Z		105	150826	Z		181	156450	Z		186-187	175111	E		203
115375	Z		105	150828	Z		181	156475	Z		186-187	175112	E		203
115500	M		99	150842	Z		181	160010	H		192	175130	E		203
115602	Z		103	150843	Z		181	160200	V	10	193	175131	E		203
115604	Z		103	150845	Z		181	160210	V	10	193	175132	E		203
115605	Z	6	103	150846	Z		181	160220	V	10	193	175140	E		201
115607	Z	6	103	150849	Z		181	160300	V	25	190	175141	E		201
115608	Z	6	103	150851	Z		179	161010	H		192	175142	E		201
115609	Z		102	150855	Z		181	163020	E		190	175200	Z		91, 95, 122, 142-143, 167, 173, 177, 179-180, 182
115610	M		102	150858	Z		181	163350	Z		190				
115611	M		102	150868	Z		181	164011	E		191				
115612	Z		103	150873	Z		181	164050	E		191	180000	Z		225
115621	Z		102	150882	Z		181	164110	E		191	180001	Z		227
115633	S		102	150883	Z		181	164111	Z		191	180010	E		225
115661	Z		102	150885	Z		181	164115	Z		191	180011	E		227
115667	Z		102	150886	Z		181	164250	Z		191	180012	E		231
116000	H		90	150887	Z		181	170010	H		206	180015	Z		233-235
116005	H		90	150888	Z		181	170011	Z		210	180020	E		225
11601															

List of articles

Art.-No.	RG	VE	Page	Art.-No.	RG	VE	Page	Art.-No.	RG	VE	Page	Art.-No.	RG	VE	Page
181020	V		234	256440	Z		215	341444	S		38	521000	Z		28
181025	V		234	256450	Z		215	341445	S		38	521002	Z		28
181030	V		234	256460	Z		215	341446	S		38	521010	Z		28
181035	V		234	256470	Z		215	341466	S		38	521012	Z		28
181040	V		234	256480	Z		215	341467	S		38	521020	Z		28
181045	V		234	256490	Z		215	341468	S		38	521022	Z		28
181050	V		234	256500	Z		215	341469	S		38	521026	Z		23
181057	V		234	256510	Z		215	341470	S		38	521030	Z		28
181060	V		234	256520	Z		215	341471	S		38	521032	S		28
181065	V		234	256530	Z		215	341472	S		38	521036	Z		23
181070	V		234	261001	E		214	341473	S		38	521040	Z		28
181075	V		234	290000	H		71	341474	S		38	521042	S		28
181080	V		234	290016	V	10	71-72	341475	S		38	521046	Z		23
181085	V		234	290050	H		71	341476	S		38	521050	N		28
181090	V		234	290100	H		71	341477	S		38	521052	Z		28
181095	V		234	290116	V	10	71-72	341478	S		38	521056	N		23
181410	V		235	290200	H		71	341479	S		38	521060	Z		28
181415	V		235	290216	V	10	71-72	341480	S		38	521062	S		28
181420	V		235	290300	H		71	341481	S		38	521066	Z		23
181425	V		235	290316	V	5	71-72	341482	S		38	521070	Z		28
181430	V		235	290400	H		83	341483	S		38	521072	Z		28
181435	V		235	290410	H		84	341484	S		38	521080	Z		28
181440	V		235	290411	H		84	341485	S		38	521082	Z		28
181445	V		235	290412	H		84	341486	S		38	521100	Z		28
181450	V		235	290420	Z		83	341487	S		38	521102	Z		28
181457	V		235	290421	Z		83	341488	S		38	521110	Z		28
181460	V		235	290422	Z		83	341489	S		38	521112	Z		28
181465	V		235	290423	Z		83	341490	S		38	521120	Z		28
181470	V		235	290424	Z		83	341491	S		38	521122	S		28
181475	V		235	290425	Z		83	341493	S		38	521130	N		28
181480	V		235	290426	Z		83	341494	S		38	521132	S		28
181700	V		236	290427	Z		83	341495	S		38	521140	Z		28
181710	V		236	290430	Z		83	341496	S		38	521142	Z		28
181711	V		236	290431	Z		83	341497	S		38	521150	Z		28
181712	V		236	290432	Z		83	341498	S		38	521152	Z		28
181713	V		236	290433	Z		83-84	341499	S		38	521160	Z		28
181714	V		236	290437	Z		83	341614	V	10	31, 33, 35, 37, 68, 72	521162	Z		28
181715	V		236	290440	Z		83-84	344100	Z		31, 33, 35, 37, 51	521170	Z		28
182006	Z		233	290444	Z		83	344105	Z		31, 33, 35, 37, 51	521172	Z		28
182009	Z		233	290445	Z		83	344150	Z		31, 33, 35, 37, 51	521180	Z		28
182050	Z		233	290446	Z		83	347000	M		31, 33, 35, 37, 48	521182	Z		28
183000	Z		229	290447	Z		83	347001	M		48	521200	Z		28
183010	E		229	290448	Z		83	347002	M		48	521202	Z		28
183022	E		229	290449	Z		83	347003	M		48	521210	Z		28
183023	E		229	291000	H		82	347004	M		48	521212	S		28
183600	Z		232	291023	Z		82	347006	M		49	521220	Z		28
183603	Z		233	291101	H		82	347007	Z		48	521222	S		28
183604	Z		233	291111	Z		82	347008	M		49	521230	Z		28
183605	Z		233	291112	Z		82	347009	M		49	521232	S		28
183606	Z		233, 241	291200	H		82	347010	Z		49	521240	Z		28
183607	Z		233	291201	Z		82	347030	Z		48	521242	Z		28
183632	Z		229, 232	291220	H		82	347034	Z		48	521250	Z		28
183670	Z		233	291221	Z		82	347035	Z		48	521252	Z		28
183675	Z		233	291240	H	8	81	347040	Z		48	521260	Z		28
183700	Z		232	291241	Z		81	347046	Z		48	521262	Z		28
185000	E		239	291250	H		82	347047	Z		48	521270	Z		28
185001	E		239	291251	Z		82	347053	Z		48	521272	Z		28
185010	E		239	291270	H		82	370010	M		39	521280	Z		28
185011	E		239	291271	Z		82	370011	M		39	521282	Z		28
185020	V		239	291301	Z		80	370012	M		39	521300	Z		28
185021	V		239	291310	E		80	371109	S		39	521302	Z		28
185022	V		239	292011	Z		84	371113	S		39	521310	Z		28
185024	Z		239	292110	H		84	371117	S		39	521312	Z		28
185025	V		239	292210	H		84	371134	S		39	521320	Z		28
185026	V		239	340100	Z		35, 37	371138	S		39	521322	Z		28
185027	V		239	340110	Z		51	371142	S		39	521330	Z		28
185054	Z		239	340200	M		31	380303	M		35	521332	Z		28
185058	Z		207, 239	340201	M		31	380304	M		35	521340	Z		28
185500	M		241	340202	M		31	380305	M		35	521342	Z		28
185501	M		241	340206	M		31	380306	M		35	521350	Z		28
185503	M		241	340207	M		31	380307	M		35	521352	Z		28
185504	M		241	340208	M		31	380308	M		35	522000	Z		22-27
185510	Z		241	340220	M		33	380309	M		35	522051	Z		23
185511	Z		241	340221	M		33	380310	M		35	526050	Z		22
185512	Z		241	340222	M		33	380311	M		35	526052	Z		23
185513	Z		241	340226	M		33	380312	M		35	530000	Z		25
185514	Z		241	340227	M		33	380313	M		35	530003	Z		24
185515	Z		241	340228	M		33	380314	M		35	530013	Z		24
185527	Z		241	340230	M		51	380426	M		37	530014	Z		24
190000	E		91	340231	M		51	380427	M		37	530020	Z		25
190010	E		91	340232	M		51	380428	M		37	530022	Z		25
190051	Z		91	341000	Z		31, 33, 35, 37	380429	M		37	530023	Z		25
190053	Z		91	341401	S		38	380430	M		37	533000	Z		24-25
250020	E		220	341402	S		38	380431	M		37	536000	Z		24-25
250041	E		220	341403	S		38	380441	M		37	540000	Z		26
250042	E		220	341404	S		38	380442	M		37	540001	Z		27
250120	E		220	341406	S		38	380443	M		37	540020	Z		26
250142	E		220	341407	S		38	380444	M		37	540022	Z		26
250143	E		220	341408	S		38	380445	M		37	540023	Z		27
250220	E		220	341409	S		38	380446	M		37	540024	Z		27
250242	E		220	341411	S		38	380447	M		37	540025	Z		27
250243	E		220	341412	S		38	380448	M		37	541401	Z		29
250320	E		220	341413	S		38	381000	Z		35, 37	541404	Z		29
250341	Z		220	341414	S		38	381050	Z		35	541406	Z		29
250342	Z		220	341416	S		38	381401	S		38	541410	Z		29
250343	Z		220	341417	S		38	381405	S		38	541413	Z		29
252026	M		216	341418	S		38	381410	S		38	541414	Z		29
252046	M		217	341419	S		38	381415	S		38	541415	Z		29
252103	Z		216-217	341426	S		38	381430	S		38	541416	Z		29
254025	M		218	341427	S		38	381431	S		38	543000	Z		26
254103	Z		218	341428	S		38	381432	S		38	543010	Z		27
255020	M		219	341429	S		38	381433	S		38	543100	Z		24-26, 59-60
255103	Z		219	341430	S		38	381622	V	5	35, 37, 68, 72	546000	Z		26-27
256020	E		215	341431	S		38	520003	H		22	560000	Z		59
256042	E		215	341432	S		38	520004	H		22	560001	Z		59

List of articles

Art.-No.	RG	VE	Page	Art.-No.	RG	VE	Page	Art.-No.	RG	VE	Page	Art.-No.	RG	VE	Page
560051	E		61	570650	Z		151, 153, 157	571780	Z		146-147, 149,	573162	Z		170
561001	V		62	570670	Z		151, 153, 157				151-152, 158	573164	Z		170
561002	V		62	570680	Z		153, 157	571785	Z		146-147, 149,	573166	Z		170
561003	V		62	570685	Z		157				151-152, 158	573168	Z		170
561004	V		62	570690	Z		153	571790	Z		146-147, 149,	573170	Z		170
561005	V		62	570695	Z		146, 157				151-152, 158	573172	Z		170
561006	V		62	570715	Z		147, 152, 154	571795	Z		146-147, 149,	573176	Z		170
561007	V		62	570717	Z		145-146, 148,				151-152, 158	573178	Z		170
561008	V		62				150, 154, 159	571855	Z		157	573180	Z		170
561101	V		63	570720	Z		147-148, 150, 152, 154	571865	Z		163	573184	Z		170
561102	V		63	570725	Z		147, 152, 154	571866	Z		137, 163	573186	Z		170
561103	V		63	570727	Z		145-146, 148,	571870	Z		163	573188	Z		170
561104	V		63				150, 154, 159	571871	Z		163	573190	Z		170
561105	V		63	570730	Z		145-148, 150,	571887	Z		163	573282	Z		172-173
561106	V		63				152, 154, 159	571889	Z		163	573284	Z		167
561107	V		63	570735	Z		145-148, 150,	571890	Z		163	573320	Z		170
561108	V		63				152, 154, 159	571891	Z		137, 163	573325	Z		170
561109	V		63	570742	Z		145, 147-148,	571895	Z		163	573330	Z		170
561110	V		63				150, 152, 154	571896	Z		137, 163	573335	Z		170
561111	V		63	570745	Z		145, 147-148,	571900	Z		149, 153-154	573360	Z		170
561112	V		63				150, 152, 154	571902	Z		149, 153-154	573364	Z		170
561113	V		63	570750	Z		145, 147, 150-153, 157	571932	Z		147	573367	Z		170
561114	V		63	570760	Z		146-147, 151-152,	571934	Z		147	573370	Z		170
561115	V		63				154, 158-159	571980	Z		150	573400	Z		170
561116	V		63	570765	Z		145-154, 156-159	572101	Z		139	573402	Z		170
561117	V		63	570770	Z		145-154, 157, 159	572111	Z		139	573404	Z		170
561118	V		63	570775	Z		145-154, 156-159	572365	Z		145-154, 156-157, 159	573406	Z		170
561119	V		63	570780	Z		145-154, 157-159	572385	Z		145, 147-148,	573430	Z		173
561120	V		63	570785	Z		145-154, 156-159				150, 152, 154	573432	Z		173
561121	V		63	570790	Z		145-154, 156-159	572400	Z		145-154, 156-159	573434	Z		173
561122	V		63	570795	Z		145-154, 156-157, 159	572405	Z		145-154, 156-159	573436	Z		173
561123	V		63	570845	Z		145-146, 150, 154	572470	Z		148	573438	Z		173
561124	V		63	570850	Z		145-148, 150,	572600	Z		150, 153	573439	Z		170
561125	V		63				152, 154, 157	572605	Z		150, 153	573624	Z		170
561126	V		63	570855	Z		145-148, 150, 152, 154	572610	Z		150, 153	573628	Z		170
563000	Z		59-60	570860	Z		145-148, 150,	572615	Z		150, 153	573630	Z		170
563008	Z		59-60				152, 154, 157	572620	Z		150, 153	573632	Z		170
563100	Z		59-60	570870	Z		145-148, 150,	572625	Z		150, 153	573636	Z		170
563200	Z		59-60				152, 154, 157	572630	Z		157	573640	Z		170
565051	Z		65	570880	Z		145-148, 150,	572632	Z		157	573644	Z		170
565225	Z		61, 115				152, 154, 157	572634	Z		157	573646	Z		170
566025	Z		61				158	572636	Z		157	573647	Z		169
566051	Z		56-57, 59-60	570905	Z		158	572638	Z		157	573648	Z		169
570100	Z		145-148, 152-153,	570910	Z		146, 148, 152, 158-159	572640	Z		157	573649	Z		169
			155-156, 158-159	570915	Z		146, 148, 152, 158-159	572642	Z		145	573652	Z		170
570107	Z		145-151, 155-156,	570920	Z		152, 158	572644	Z		145	574000	H		138
			158-159	570925	Z		146, 148, 152, 158-159	572646	Z		145-146	574300	H		168
570110	Z		145-156, 158-159	570930	Z		155-156, 159	572648	Z		145	574302	H		168
570112	Z		146-147, 149,	570932	Z		155-156	572670	Z		154	574352	Z		168
			155-156, 158	570935	Z		149, 154-156, 159	572672	Z		154	574430	Z		138
570115	Z		145-156, 158-159	570937	Z		155-156	572674	Z		154	574436	Z		74-75, 138
570117	Z		146-147, 149,	570940	Z		149, 154-156, 159	572676	Z		154	574437	Z		168
			155-156, 158	570945	Z		149, 154-156, 159	572678	Z		154	574500	Z		160
570120	Z		145-156, 158-159	570950	Z		149, 154-156, 159	572680	Z		154	574502	Z		125, 127-128, 130,
570125	Z		145-156, 158-159	570955	Z		149, 154-156, 159	572687	Z		147, 151, 153-154, 158				133-136, 145,
570130	Z		145-156, 158-159	571003	Z		142	572689	Z		147, 151, 153-154, 158				147-151, 155-156,
570132	Z		155-156, 158	571004	Z		143	572691	Z		147, 151, 153-154, 158				158-159
570135	Z		145-156, 158-159	571013	E		142	572693	Z		151, 153-154, 158				125-136, 145-156,
570137	Z		155-156, 158	571014	E		143	572695	Z		151, 153-154, 158				158-159
570140	Z		145-156, 158-159	571290	Z		142-143	572697	Z		151, 153-154, 158				158-159
570145	Z		145-156, 158-159	571320	Z		145-146, 153-154, 157	572699	Z		145-156, 158-159				125-136, 145-156,
570150	Z		145-156, 158-159	571325	Z		145-150, 152-154, 157	572706	Z		145-156, 158-159				158-159
570155	Z		145-156, 158-159	571327	Z		145-146, 148	572708	Z		145-156, 158-159				125-136, 145-156,
570160	Z		146-149, 151, 153,	571330	Z		145-150, 152-154, 157	572795	Z		160				158-159
			156, 158-159	571335	Z		145-149, 152-154, 157	572801	Z		160				125-136, 145-156,
570165	Z		145-156, 158-159	571337	Z		150, 153, 157	572802	Z		160				158-159
570170	Z		146-149, 151, 153,	571340	Z		145-149, 152-153, 157	572809	Z		160				125-136, 145-156,
			156, 158-159	571342	Z		150, 153, 157	572810	Z		160				158-159
570175	Z		145-156, 158-159	571360	Z		151	572815	Z		152-153, 158				125-136, 145-156,
570280	Z		139-141	571370	Z		151	572816	Z		152-153, 158				158-159
570290	Z		160	571375	Z		151	572817	Z		152-153, 158				136-160
570295	Z		160, 163	571380	Z		151	572818	Z		152-153, 158				125-128, 130-131,
570300	Z		145, 152, 157	571432	Z		147	572819	Z		147, 149, 151, 158				133-136, 145-148,
570310	Z		145-147, 150,	571434	Z		147	572820	Z		147, 149, 151, 158				152-153, 155-156,
			152, 154, 157	571436	Z		147	572821	Z		147, 149, 151, 158				158-159
570315	Z		152	571438	Z		147	572822	Z		158				125-136, 145-156,
570320	Z		145-150, 152-154,	571440	Z		147	572823	Z		158				158-159
			156-157, 159	571450	Z		145, 159	572824	Z		158				125-136, 145-156,
570330	Z		150, 152, 157	571455	Z		145, 159	572828	Z		145-146, 149,				158-159
570340	Z		145-148, 150,	571460	Z		145, 159	572829	Z		151-154, 157, 159				125-136, 145-156,
			152, 154, 157	571465	Z		145, 159				145, 149-150,				158-159
570350	Z		145-150, 152-154,	571470	Z		145, 159	572830	Z		152, 154, 157				125-136, 145-151,
			156-157, 159	571475	Z		145, 159				145, 148, 154				153-156, 158-159
570360	Z		145, 148-150, 152, 157	571477	Z		145, 159	572833	Z		157				127-128, 147, 149
570370	Z		145-150, 152-154,	571545	Z		91, 95, 122, 167,	572834	Z		157				127-128, 147, 149
			156-157, 159				177, 179-180, 182	572835	Z		157				133, 135, 155-156, 158
570380	Z		145-150, 152-154,	571555	Z		91, 95, 122, 142-143,	572837	Z		145-150, 152-154,				182
			156-157, 159				167, 173, 177,				157, 159				177
570390	Z		145, 147-148, 150,	571560	Z		179-180, 182	572839	Z		153-154				182
			152, 154, 157				61, 75, 91, 95, 115,	572840	Z		153-154				177
570400	Z		148				122, 142-143, 167,	572841	Z		153-154</				

List of articles

Art.-No.	RG	VE	Page	Art.-No.	RG	VE	Page	Art.-No.	RG	VE	Page	Art.-No.	RG	VE	Page
578324	Z		125-128, 130, 133-136	578588	Z		129, 131	590055	Z		109	759263	S		42
578326	Z		126-128, 133, 135	578590	Z		129, 131	590056	Z		109	759264	S		42
578328	Z		125-136	578592	Z		129, 131	590057	Z		109	759265	S		42
578330	Z		126-128, 133, 135	578594	Z		129, 131	590058	Z		109	759270	S		42
578332	Z		125-136	578596	Z		129, 131	590059	Z		109	759271	S		42
578334	Z		125-136	578598	Z		129, 131	590060	Z		109	759272	S		42
578336	Z		125-136	578600	Z		129, 131	590061	Z		109	759273	S		42
578338	Z		133, 135	578602	Z		135	590062	Z		109	759274	S		42
578340	Z		133, 135	578604	Z		125-136	590111	Z		109	759275	S		42
578342	Z		127-129, 131	578606	Z		125-126, 128, 130, 135	590150	Z		109	759276	S		42
578344	Z		128-129, 135	578608	Z		125	590153	Z		109	759277	S		42
578346	Z		127-129, 136	578610	Z		125	590160	Z		109, 111	759278	S		42
578348	Z		125-132, 134-136	578612	Z		125	731200	Z		29	759279	S		42
578350	Z		126-127, 129, 131	578614	Z		125	731205	Z		29	759280	S		42
578352	Z		125-132, 134-136	578618	Z		134	731210	Z		29	759281	S		42
578354	Z		126-129, 132, 135-136	578620	Z		137	731220	Z		29	759282	S		42
578356	Z		125-132, 134-136	578621	Z		137	731230	Z		29	759330	S		42
578358	Z		125-132, 134-136	578622	Z		137	731240	Z		29	759360	S		42
578360	Z		125-132, 134	578624	Z		125-132, 134-136	731250	Z		29	759361	S		42
578362	Z		125-132, 134-136	578630	Z		126, 130-131, 135	731301	Z		29	759362	S		42
578364	Z		125-132, 134-136	578632	Z		126, 130-131, 135	731302	Z		29	759363	S		42
578366	Z		126, 128-129, 134-135	578634	Z		126, 130-131, 135	731303	Z		29	759364	S		42
578372	Z		126-127, 129-130, 132, 135-136	578636	Z		130-131, 135	731304	Z		29	759365	S		42
578374	Z		125-132, 134-136	578638	Z		125, 127	731305	Z		29	759366	S		42
578376	Z		125-132, 134-136	578640	Z		135	731306	Z		29	759367	S		42
578378	Z		125-132, 134-136	578642	Z		135	731307	Z		29	759368	S		42
578380	Z		125-132, 134-136	578644	Z		135	731308	Z		29	759369	S		42
578382	Z		125-132, 134-136	578646	Z		135	731309	Z		29	759370	S		42
578386	Z		125-132, 134-136	579104	Z		147	731310	Z		29	759371	S		42
578390	Z		125-136	579105	Z		147	731311	Z		29	759372	S		42
578392	Z		125-126, 129-131, 134	579106	Z		147	731312	Z		29	759373	S		42
578394	Z		130	579120	Z		160	731320	Z		29	759374	S		42
578396	Z		125, 130, 134	580000	Z		113, 116	731321	Z		29	759375	S		42
578398	Z		125-127, 129-130, 132, 134-135	580002	Z		115	731322	Z		29	759376	S		42
578400	Z		125-132, 134-136	580010	Z		113	731323	Z		29	759377	S		42
578402	Z		129-130, 134	580012	Z		115	731324	Z		29	759378	S		42
578404	Z		125-132, 134	580020	Z		113	731325	Z		29	759379	S		42
578406	Z		125-132, 134-136	580021	Z		113	731326	Z		29	759380	S		42
578408	Z		125-128-130, 134	580023	Z		113	731700	Z		24-27, 85	759381	S		42
578410	Z		125-132, 134-136	580024	Z		113	750003	U		41	759382	S		42
578412	Z		125-132, 134, 136	580025	Z		113	750004	U		41	759383	S		42
578418	Z		134	580026	Z		113	751000	Z		41	759384	S		42
578420	Z		130-131, 134	580027	Z		113	751040	Z		41, 45	770003	U		45
578422	Z		134	580028	Z		113	751050	Z		41, 45	770004	U		45
578426	Z		130-131, 134	580029	Z		113	751060	Z		41, 45	771000	Z		45
578430	Z		130-131, 134	580030	Z		113	751070	Z		41, 45	771110	S		45
578432	Z		131, 134	580031	Z		113	751080	Z		41	771120	S		45
578434	Z		132	580033	Z		113	751090	Z		41	771130	S		45
578436	Z		132	580034	Z		113	751096	Z		41	771136	S		45
578438	Z		132	580035	Z		113	751097	Z		41	771140	S		45
578440	Z		132	580036	Z		113	751098	Z		41	771160	S		45
578442	Z		132	580070	Z		115	751100	Z		41	771170	S		45
578444	Z		128	580071	Z		115	751102	Z		41	771180	S		45
578446	Z		128	580072	Z		115	751109	S		42	771186	S		45
578448	Z		128	580073	Z		115	751502	S		42, 45	771190	S		45
578450	Z		128	580074	Z		115	751503	S		42, 45	771210	S		45
578452	Z		128	580075	Z		115	751504	S		42	771220	S		45
578454	Z		132	580076	Z		115	751505	S		42	771230	S		45
578456	Z		125-127, 129-132, 136	580077	Z		115	751506	S		42, 45	771240	S		45
578458	Z		126-127, 129, 131-132	580078	Z		115	751507	S		42, 45	771246	S		45
578460	Z		125-127, 129-132, 136	580079	Z		115	751508	S		42	771260	S		45
578462	Z		125-127, 129-132, 136	580081	Z		115	751509	S		42	771270	S		45
578464	Z		125-127, 129-132, 136	580083	Z		115	751510	S		42	771280	S		45
578466	Z		125-126, 129, 132	580084	Z		115	751511	S		42	771290	S		45
578468	Z		125-132, 134	580100	Z		111	751516	S		42	771296	S		45
578470	Z		125-129, 131-132	580110	Z		111	751517	S		42	773060	Z		45
578472	Z		125-132, 134	581070	Z		117	751518	S		42	844010	Z		74
578474	Z		125-132, 134	581080	Z		117	751519	S		42	844011	Z		75
578476	Z		125-132, 134	581110	Z		117	751520	S		42	844050	Z		74-75
578478	Z		127, 129-132	581130	Z		117	751521	S		42	844051	Z		74-75
578480	Z		135	581150	Z		117	751522	S		42	844510	Z		75
578482	Z		126-127, 131, 135-136	581180	Z		117	751523	S		42	845001	M		77
578484	Z		126-127, 131, 135-136	581200	Z		117	751524	S		42	845003	M		77
578486	Z		131, 135	581210	Z		117	751525	S		42	845004	M		79
578488	Z		126-127, 131, 135-136	581220	Z		117	751526	S		42	845050	Z		77, 79
578490	Z		125-126, 131-132, 134	581230	Z		117	751527	S		42	845051	Z		77, 79
578492	Z		125-128, 130-132, 134	581240	Z		117	751528	S		42	845052	Z		77, 79
578494	Z		125-128, 130-132, 134	581260	Z		117	751544	S		42	845053	Z		77, 79
578496	Z		125-128, 130-132, 134	581270	Z		117	751545	S		42, 45	845054	Z		77
578498	Z		125, 127-128, 130-131, 134	581280	Z		117	751546	S		42, 45	845055	Z		77, 79
578510	Z		133-134, 136	581310	Z		117	751547	S		42, 45	845057	Z		79
578512	Z		133	581320	Z		117	751548	S		42	845060	Z		79
578514	Z		128, 132-134, 136	581330	Z		117	751549	S		42	845110	Z		77
578516	Z		133	581350											

REMS

www.rems.de

Head Office

 **Germany:** REMS GmbH & Co KG
Postfach 1631 · D-71306 Waiblingen
Stuttgarter Straße 83 · D-71332 Waiblingen
Tel +49 7151 17 07-0 · Fax +49 7151 17 07-110
info@rems.de

Branch Offices

 **Denmark:** REMS Scandinavia A/S
Snedkervej 1 · DK-4600 Køge
Tel +45 56 63 14 00 · Fax +45 56 63 11 78
DNK@rems.de

 **France:** REMS S.à.r.l.
2, Rue du Stade · F-67250 Hoffen
Tel +33 388 80 44 53 · Fax +33 388 80 99 43
FRA@rems.de

 **Great Britain:** REMS (UK) Ltd.
Unit 5 · Ash Industrial Estate
Flex Meadow · Harlow · Essex CM19 5TJ · U.K.
Tel +44 1279 413698 · Fax +44 1279 413704
GBR@rems.de

 **Italy:** REMS S.r.l.
Via Sirtori, 13/D · I-20017 Passirana di Rho (Milano)
Tel +39 02 9 30 21 11 · Fax +39 02 9 31 02 45
ITA@rems.de

 **Poland:** REMS POLSKA Sp. z o.o.
Dąbrowa · Ulica Piaskowa 19
PL 62-070 Dopiewo
Tel +48 61 654 09 00 · Fax +48 61 654 09 05
POL@rems.de

 **Spain:** REMS ESPAÑA, S.A.U.
Pol. Ind. San José de Valderas
Calle Herramientas, 28 · E-28918 Leganés (Madrid)
Tel +34 916 444 833 · Fax +34 916 430 155
ESP@rems.de

 **Czech Republic:** REMS Česká republika s.r.o.
Nádražní 271 · CZ 253 01 Hostivice
Tel +420 2 20 98 28 80 · Fax +420 2 20 98 28 83
CZE@rems.de

Sale through specialist dealers.